

SINCE 1889



Rotary Evaporator

Model:RE301

Instruction Manual

- The Second Edition -

This document is the exclusive instruction manual to the RE301 model rotary evaporator main unit.

Please use this document together with the instruction manual of the VR300 model vacuum controller or TA300 model vapor temperature indicator as for the operating instructions of device.

- Thank you for purchasing "Rotary Evaporator, RE Series" of Yamato Scientific Co., Ltd.
- To use this unit properly, read this "Instruction Manual" thoroughly before using this unit. Keep this instruction manual around this unit for referring at anytime.



WARNING!

Carefully read and thoroughly understand the important warning items described in this manual before using this unit.

Yamato Scientific America Inc.

| | |
|--|----|
| ◆ 1.Contents in the Package..... | 1 |
| ◆ 2.Cautions in Using with Safety..... | 2 |
| • Explanation..... | 2 |
| • Table of Illustrated Symbols | 3 |
| • Fundamental Matters of "WARNING!" and "CAUTION!" | 4 |
| ◆ 3.Before Using This Unit..... | 6 |
| ◆ 4.Outside Appearance..... | 9 |
| ◆ 5.Installation Method..... | 10 |
| • RE301 model installation..... | 10 |
| • Installation Method | 11 |
| • Connecting method and assembling procedures of glass unit..... | 14 |
| • Installation Method (Optional accessories) | 17 |
| ◆ 6.Control Panel..... | 22 |
| ◆ 7.Operation Function | 23 |
| ◆ 8.Description and Function of Each Part | 24 |
| ◆ 9.Handling Precautions | 26 |
| ◆ 10.Maintenance Method..... | 27 |
| ◆ 11.Long storage and disposal..... | 28 |
| ◆ 12.In the Event of Failure... .. | 29 |
| • Safety Device and Error Code..... | 29 |
| • Trouble Shooting | 29 |
| ◆ 13.After Service and Warranty | 30 |
| ◆ 14.Specification | 31 |
| ◆ 15.Wiring Diagram..... | 32 |
| ◆ 16.Replacement Parts Table..... | 33 |
| ◆ 17.List of Dangerous Materials | 34 |
| ◆ 18. Standard Installation Manual..... | 35 |

1.Contents in the Package

Contents in the Package

Affirmation of content package

Check the content of package before setting up the device.

Contact our selling office or sales office if any components or parts are missing.

| RE301 main unit(main unit and appurtenant) | | | | |
|--|-------------------------------|--------|-------|-------|
| No. | Name | QTY | Notes | check |
| 1 | RE301 main unit | 1 set | | |
| 2 | Vacuum seal | 1 | | |
| 3 | Condenser fixing nut | 1 | | |
| 4 | Coil ring | 1 | | |
| 5 | Rotary joint retainer | 1 | | |
| 6 | Ring(large/middle/small) | each 1 | | |
| 7 | O-ring | 2 | | |
| 8 | Vacuum grease | 1 | | |
| 9 | Power cord | 1 | | |
| 10 | Bath ways | 1 | | |
| 11 | Instruction manual | 1 | | |
| 12 | Warranty card | 1 | | |
| 13 | Battery(9V alkaline dry cell) | 2 | | |

Caution: Please check being attached to RE main part about 1-7.

2.Cautions in Using with Safety

Explanation

MEANING OF ILLUSTRATED SYMBOLS

Illustrated Symbols

Various symbols are used in this safety manual in order to use the unit without danger of injury and damage of the unit. A list of problems caused by ignoring the warnings and improper handling is divided as shown below. Be sure that you understand the warnings and cautions in this manual before operating the unit.

 **WARNING!** If the warning is ignored, there is the danger of a problem that may cause a serious accident or even fatality.

 **CAUTION!** If the caution is ignored, there is the danger of a problem that may cause injury/damage to property or the unit itself.

Meaning of Symbols



This symbol indicates items that urge the warning (including the caution). A detailed warning message is shown adjacent to the symbol.



This symbol indicates items that are strictly prohibited. A detailed message is shown adjacent to the symbol with specific actions not to perform.



This symbol indicates items that should be always performed. A detailed message with instructions is shown adjacent to the symbol.

2.Cautions in Using with Safety

Table of Illustrated Symbols

Warning



Warning,
generally

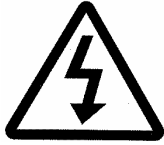

Warning,
high voltage



Warning,
high temperature



Warning,
drive train

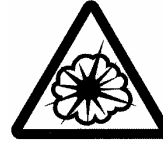

Warning,
explosive

Caution



Caution,
generally



Caution,
electrical shock



Caution,
scald



Caution,
no road heating



Caution,
not to drench



Caution,
water only



Caution,
deadly poison



Caution,
water

Prohibit



Prohibit,
generally



Prohibit,
inflammable



Prohibit,
to disassemble



Prohibit,
to touch

Compulsion



Compulsion,
generally



Compulsion,
connect to the
grounding
terminal



Compulsion,
install on a flat
surface



Compulsion,
disconnect the
power plug



Compulsion,
periodical
inspection

2.Cautions in Using with Safety

Fundamental Matters of "WARNING!" and "CAUTION!"

! WARNING!

⊘ Do not use this unit in an area where there is flammable or explosive gas

Never use this unit in an area where there is flammable or explosive gas. This unit is not explosion-proof. An arc may be generated when the power switch is turned on or off, and fire/explosion may result. (Refer to page 34 "エラー! リンクが正しくありません。".)

⊕ Always ground this unit

Always ground this unit on the power equipment side in order to avoid electrical shock due to a power surge.

! Plug the power cord securely

Plug the power cord securely into the main unit. If not, overheat or fire disaster may result in.

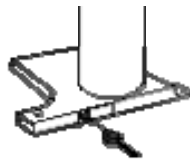

! If a problem occurs

If smoke or strange odor should come out of this unit for some reason, turn off the circuit breaker right away, and then disconnect the power plug. Immediately contact a service technician for inspection. If this procedure is not followed, fire or electrical shock may result. Never perform repair work yourself, since it is dangerous and not recommended.

⊘ Do not use the power cord if it is bundled or tangled

Do not use the power cord if it is bundled or tangled. If it is used in this manner, it can overheat and fire may be caused.

⊘ Do not process, bend, wring, or stretch the power cord forcibly

Do not process, bend, wring, or stretch the power cord forcibly. Fire or electrical shock may result.

⊘ Perform periodic check

Check the device frequently. Do not leave the dust and dirt on the wiring terminals and electrical components. A fire disaster may result in.

⊘ Substances that can not be used

Never use explosive substances, flammable substances and substances that include explosive or flammable ingredients in this unit. Explosion or fire may occur. (Refer to page 34 "エラー! リンクが正しくありません。".)

⊘ Do not disassemble or modify this unit

Do not disassemble or modify this unit. Fire or electrical shock or failure may be caused.

2.Cautions in Using with Safety

Fundamental Matters of "WARNING!" and "CAUTION!"

CAUTION!

During a thunder storm

 During a thunderstorm, turn off the power key immediately, then turn off the circuit breaker and the main power. If this procedure is not followed, fire or electrical shock may be caused.

When electric power failure occurs...

The device stops operation when electric power failure occurs. In this case, turn off the breaker for safety. When the power is applied again, if the power switch is turned on, the main unit will go to automatically upper step.

3. Before Using This Unit

Requirements for Installation

WARNING!

1. Always ground this unit



- Be sure to connect the ground wire to the earth conductor or earth terminal to prevent accidents caused by an electric shock.



- Do not connect the earth wire to gas or water pipes. If not, fire disaster may be caused.
- Do not connect the earth wire to the ground for telephone wire or lightning conductor. If not, fire disaster or electric shock may be caused.
- Consult your local electrical contractor for power connecting work.

2. Choose a proper place for installation



- Do not install this unit in a place where:
 - ◆ Rough or dirty surface.
 - ◆ Flammable gas or corrosive gas is generated.
 - ◆ Ambient temperature above 35°C.
 - ◆ Ambient temperature fluctuates violently.
 - ◆ There is direct sunlight.
 - ◆ There is excessive humidity and dust.
 - ◆ There is a constant vibration.
 - ◆ Without a ventilation system.
 - ◆ The unstable place of a power supply.



- Make sure that no flammable substances are placed around the devices. Keep space as shown, at least, in the figure below. We recommend the installation inside the ventilation system such as a draft chamber.

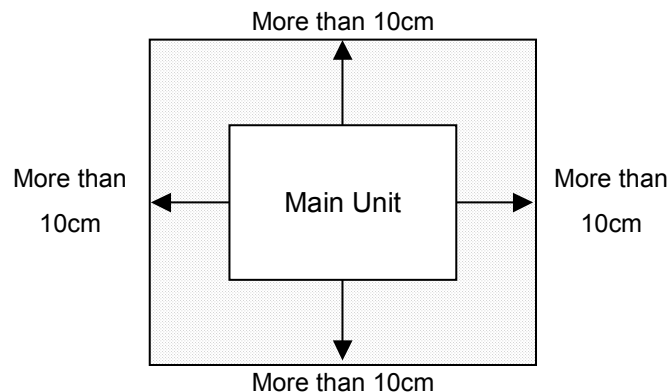

3. Do not use this unit in an area where there is flammable or explosive gas



- Never use this unit in an area where there is flammable or explosive gas. This unit is not explosion-proof. An arc may be generated when the power switch is turned ON or OFF, and fire/explosion may result.
- To know about flammable or explosive gas, refer to page 34 "17. List of Dangerous Materials".

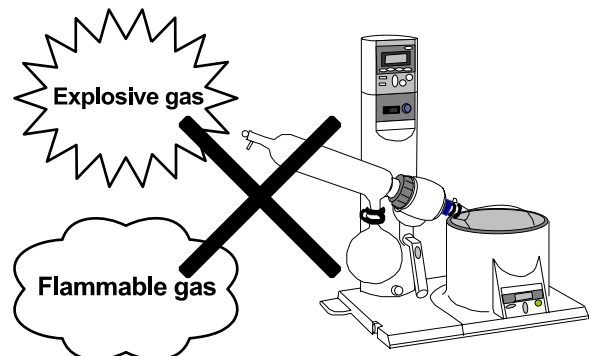

3. Before Using This Unit

Requirements for Installation

4. Install exhauster and ventilator



- Be sure to install an exhauster, ventilator and extinguisher around the device.
The oily smoke of silicone oil generated by heating is flammable and may cause fire disaster. Silicone oil also may generate harmful gas when it reaches a high temperature.

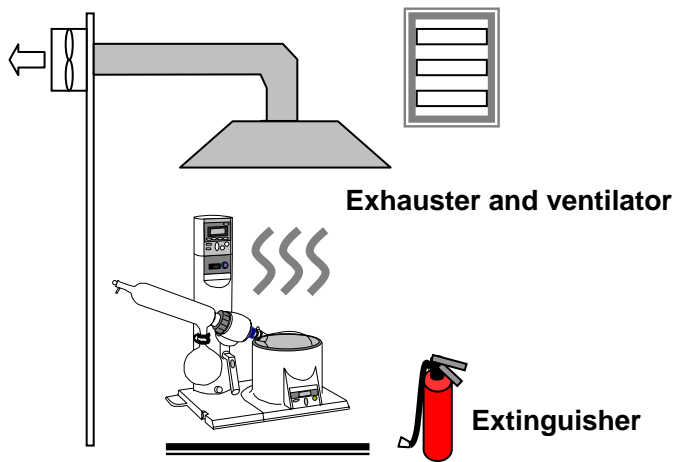

CAUTION!

5. Do not modify



- Modification of this unit is strictly prohibited. This could cause a failure.

Modification

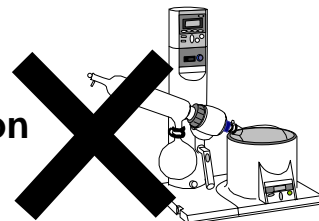

6. Installation on horizontal surface



- Place this unit as flat a place as possible. If the three rubber feet and adjuster are not in uniform contact with the floor surface, noise or vibration may result. Additionally, the unit may cause a problem or malfunction.

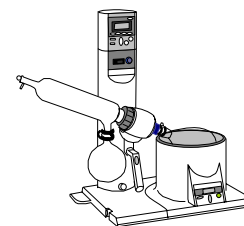

7. Choose a correct power distribution board or receptacle



- Choose a correct power distribution board or receptacle that meets the unit's rated electric capacity.

Electric capacity: RE301: 1.5A at AC100V to AC240V

Electric capacity for RE main unit (except water bath or oil bath) and vacuum controller. The water bath or oil bath uses the other power source. The electric capacity of 12.5A and 6.5A are required for the BM500/BO400 and BM510/BO410 models respectively.

NOTE)

The device adopts the free power system for AC100V to AC240V. The RE main unit includes the switching power source, the secondary power source of which is driven with DC24V. Do not connect the lines that share the power source, or do not place the appliances that generate noise around the device. A malfunction may occur on the device.

3. Before Using This Unit

Requirements for Installation

8. Before/after installing



- It may cause injury to a person if this unit falls down or moves by the earthquake and the impact. etc..To prevent, take measures that the unit cannot fall down, and not install to busy place.
- Be sure to install an exhauster, ventilator and extinguisher around the device.

9. Handling of power code



- Do not entangle the power cord. This will cause overheating and possibly a fire.
- Do not bend or twist the power cord, or apply excessive tension to it. This may cause a fire and electrical shock.
- Do not lay the power cord under a desk or chair, and do not allow it to be pinched in order to prevent it from being damaged and to avoid a fire or electrical shock.
- Keep the power cord away from any heating equipment such as a room heater. The cord's insulation may melt and cause a fire or electrical shock.



- If the power cord becomes damaged (wiring exposed, breakage, etc.), immediately turn off the power at the rear of this unit and shut off the main supply power. Then contact your nearest dealer for replacement of the power cord. Leaving it may cause a fire or electrical shock.
- Connect the power plug to the receptacle which is supplied appropriate power and voltage.

10. Precautions for use of sample including organic solvent



- Note the followings when using the sample which includes organic solvent.
 - ❖ A Teflon seal, which is sold separately, is recommended for the seal on the rotary joint.
 - ❖ A Teflon diaphragm model vacuum pump is recommended.
 - ❖ When using VR300, the electromagnetic valve for vacuum regulator control recommends you use of an optional Teflon electromagnetic valve.
 - ❖ When using VR300, a vacuum regulator pressure sensor recommends you use of the optional pressure sensor made from SUS316.

Cautions

Use an optional Teflon vacuum seal for ketone and an ether system solvent.

Acetone, methyl ethyl ketone, methyl isobutyl ketone, ethyl ether, and MTBE (methyl t-butyl ether) etc. -- the case where ketone and an ether system solvent are used -- vacuum seal (NBR) of standard attachment It will swell.

Use the fluorocarbon polymers vacuum seal of an option.

ORE80



VR type Teflon solenoid valve

ORE70



Teflon vacuum seal

ORE90



VR type pressure sensor for organic solvent

PG200 model



Teflon diaphragm model vacuum pump

4. Outside Appearance

RE301 model installation

RE301

Front view

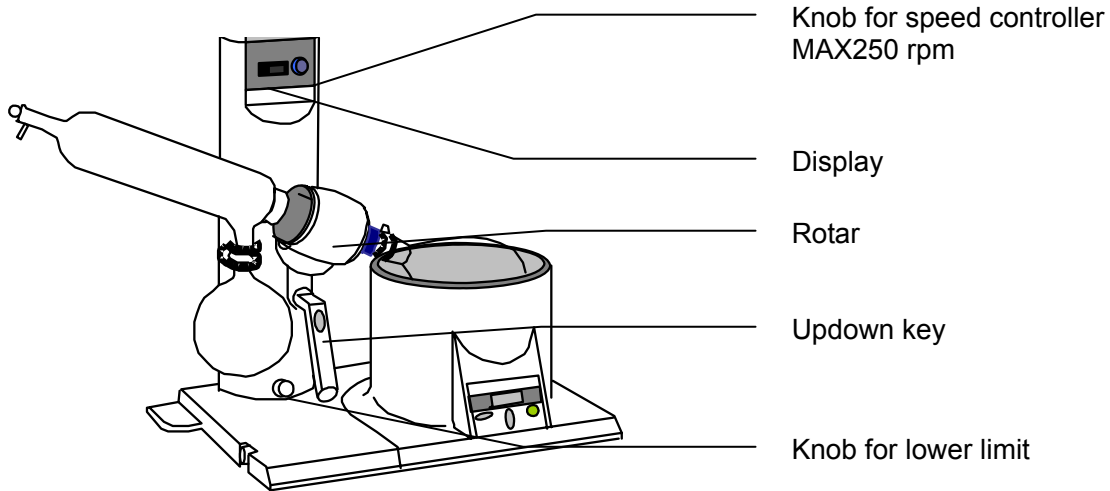

Rear view

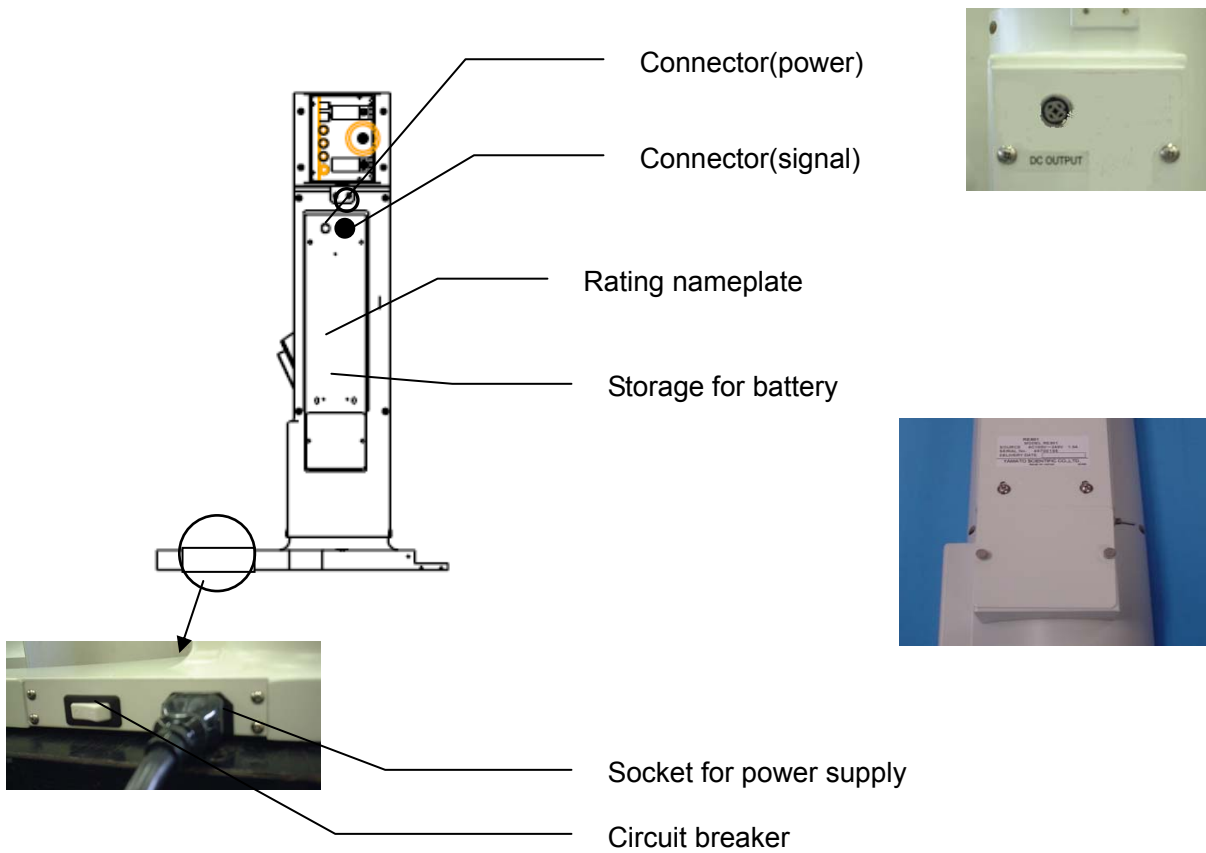

5. Installation Method

RE301 model installation

1. RE installation

Unpack the main unit of RE301 and install it on the level area.

RE301 model installation

Refer to the instruction manual of vacuum controller for the installation of VR300 model vacuum controller.

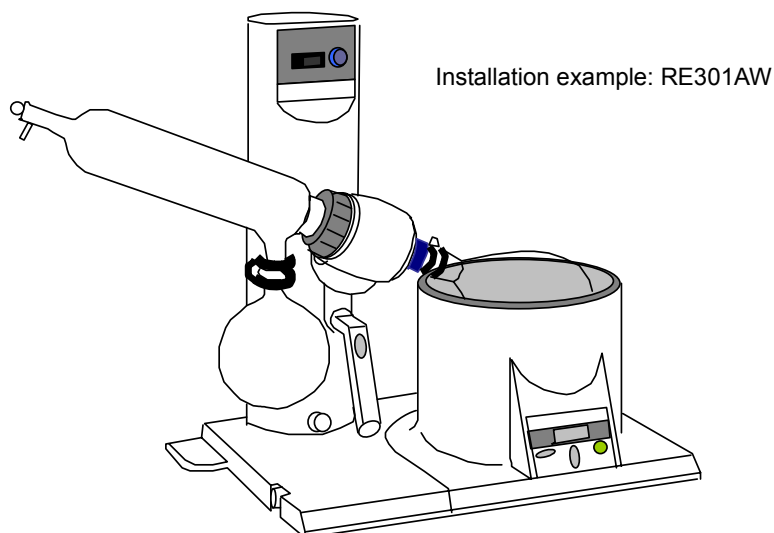

Connection on back surface area

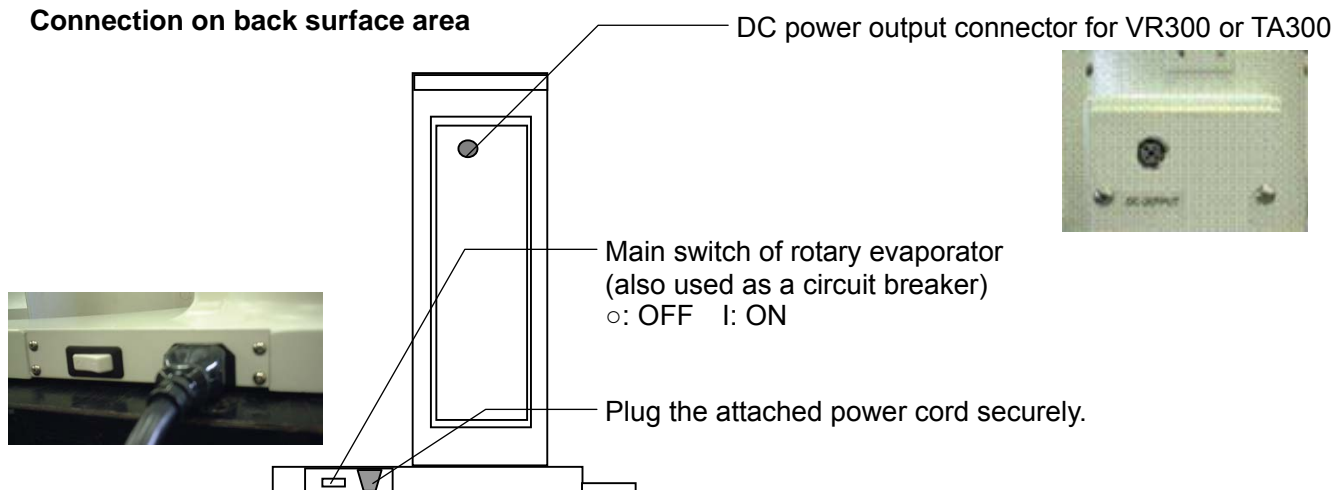

Connect a vacuum hose and a cooling hose to the cooling water circulation unit.

A vacuum hose should prepare the inside diameter of 6mm, and a cooling hose should prepare a thing with an inside diameter of 9mm.

Pipe by the length that each hose between a vacuum pump or the cooling water circulation unit is not pulled at the time of a main part lift rise.

Refer to P.17 for a piping configuration.

5. Installation Method

Installation Method

1. RE301 back surface (battery attachment)

Battery: Two 9V alkaline dry cells (accessories)

- ① Remove the screw of a back surface and remove a battery attachment plate lid.
- ② Attach 9V alkaline dry cell to a back battery storage part.
- ③ Set polarity correctly.
- ④ Attach a battery attachment plate lid with the screw.

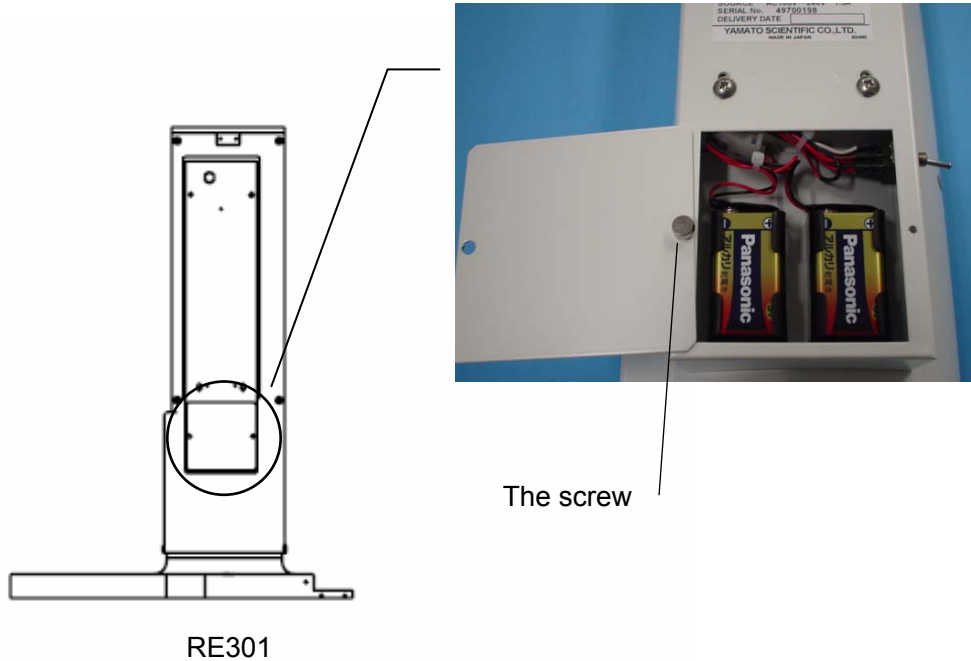

CAUTION!

- Confirm the polarity of the electrode.
- When an electrode is connected in the opposite direction, a problem occurs, and dangerous.
- Don't mix the different kind of battery .
- Remove a battery when you don't use for a long time.

5. Installation Method

Installation Method

2. Attachment of Bath ways

- 1) The base of a main part is lifted so that the bottom can be seen.

The base of a main part



- 2) An attached bath guide is inserted in a groove portion.

Bath ways



Groove portion

- 3) Please return a main part and use it as a standard of bath installation.

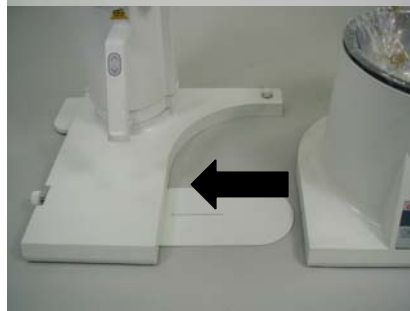

Installation Method

3. Connecting method and assembling procedures of glass unit

1) Glass set on condenser

Connect the glass set to the rotor unit on the RE main unit.

A set

Photo: RE301AW

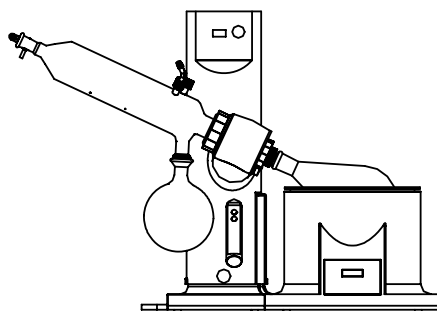

Glass set A:

The standard glass set, where the condenser is tilted to be set, suitable for distillation, concentration, and collection of samples.

B set

Photo: RE301BW

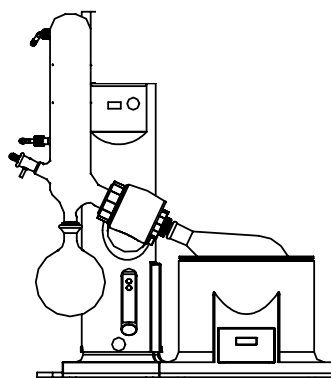

Glass set B:

The condenser is set vertically, suitable for distillation, concentration, and collection of samples regardless of their boiling point. The condenser unit and connecting pipe is integrated to realize the space-saving design. The connecting pipe is also equipped with a unique drip-proof mechanism.

C set

Photo: RE301CW

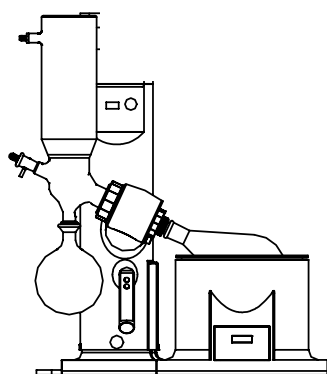

Glass set C:

The condenser is set vertically, suitable for distillation, concentration, and collection of samples which has a low boiling point, such as dry ice or ice. The condenser unit and connecting pipe is integrated to realize the space-saving design. The connecting pipe is also equipped with a unique drip-proof mechanism.

5. Installation Method

Connecting method and assembling procedures of glass unit

2) Connecting method and assembling procedures of glass unit①

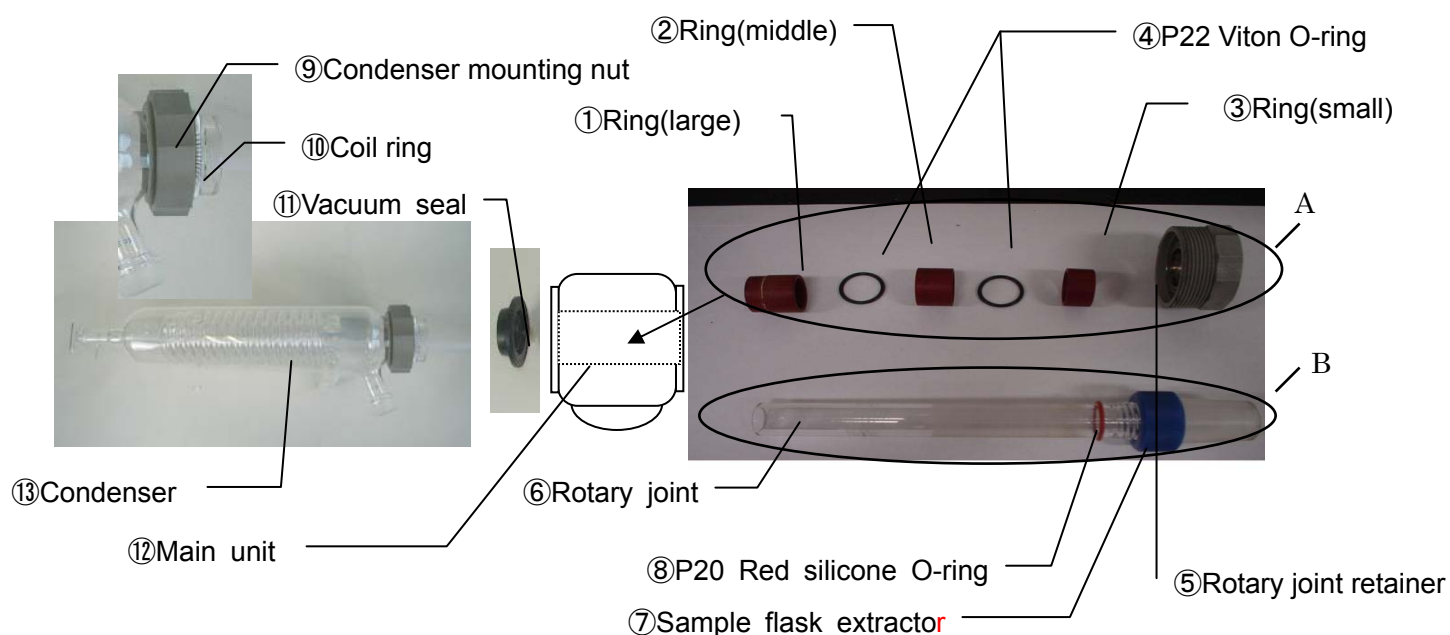

[1]How to fix the rotary joint

It is inserted into ①Ring(large)→ ④P22 Viton O-ring→ ②Ring(medium)→ ④P22 Viton O-ring→ ③ Ring(small), and it clings in the order of ⑤Rotary joint retainer in the main unit rotar part. (Figure A part)

Figure B part has a glass set attached.

1. ⑤Rotary joint retainer is relaxed.



2. ⑥Rotary joint is inserted. (Though it is possible to insert the ⑥Rotary joint any position ,it is recommended checking ⑧P20 Red silicone O-ring at the tip of ⑤Rotary joint retainer.)



3. ⑤Rotary joint retainer is tightened after ⑥Rotary joint is inserted.



5. Installation Method

Connecting method and assembling procedures of glass unit

[2] How to fix a Condenser

- ① It is passed through the condenser in order of ⑬It prepares for the condenser, in rotor installation part ⑨Condenser fixing nut → ⑩Coil ring.
- ② Apply a thin layer of silicone grease onto the mating surface with ⑥rotary joint on the ⑪Vacuum seal and fit it into the fitting area of condensation tube with the orientation shown in the figure. Insert the seal into the rotary joint together with the condensation tube and tighten it with the condenser fixing nut.

Cautions

- i . Use an optional Teflon vacuum seal for ketone and an ether system solvent.
Acetone, methyl ethyl ketone, methyl isobutyl ketone, ethyl ether, and MTBE (methyl t-butyl ether) etc.
-- the case where ketone and an ether system solvent are used -- vacuum seal (NBR) of standard attachment It will swell.
Use the fluorocarbon polymers vacuum seal of an option.
- ii . Be careful of the glass damage.
- iii . Carry out assembling in the order of [1] [2].
When [2] is fixed first, it sometimes becomes a problem cause such as vacuum omission.

5. Installation Method

Connecting method and assembling procedures of glass unit

2) Connecting method and assembling procedures of glass unit②

Setup of the sample-receiving flask (round-bottom flask) and distillation flask (recovery flask).

Apply a thin layer of silicone grease onto the facing surface as necessary and fix them with the attached clamp.

Sample-receiving flask



Flask clamp (2)

Distillation flask



Flask clamp (1)

*

*

* In using 2L flask of an optional (a distillation flask and a receptacle flask), please use the metal clamp of an optional respectively. Moreover, by the load of a repeated load, since there is a possibility of damaging, please use the resin clamp as a consumption article. (P. 34 references)

Setup of sample induction cock

Insert the sample induction cock with Teflon tube into the connecting pipe. Apply a thin layer of silicone grease onto the facing surface as necessary.

Sample induction cock (Teflon tube attached)



Nozzle • Cap for nozzles • Packing for nozzles

Stop • Cap for nozzles • Packing for stopping

5. Installation Method

Installation Method (Optional accessories)

3) Piping method

Piping between condenser and peripheral device

The rotary evaporator requires the vacuum equipment such as vacuum pump or aspirator, cooling water circulation system to cool the condenser, and tap water. Use the vacuum hose with the inner diameter of 6mm for vacuum route and heat insulation hose with the inner diameter of 9mm for cooling route. Securely fix the connection between respective hoses and resin nipple using a clamp.

Piping between RE301 and glass set condenser

Piping method to glass set A condenser

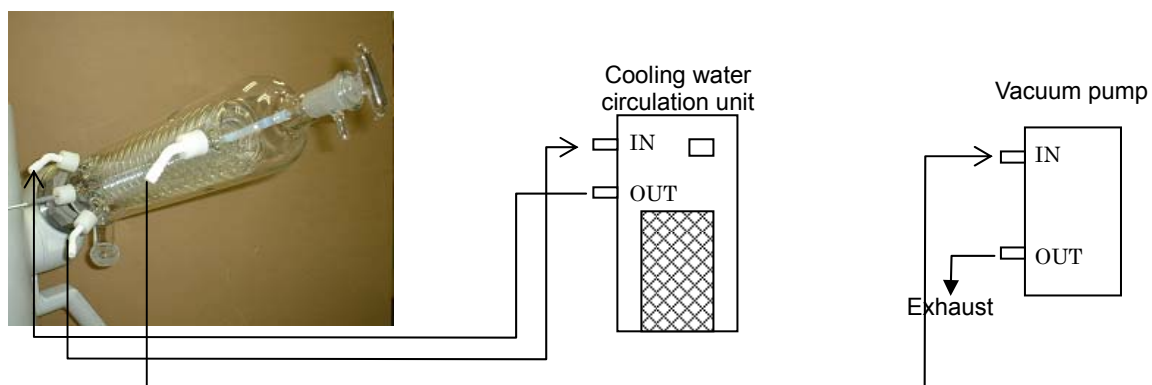

Piping method to glass set B condenser

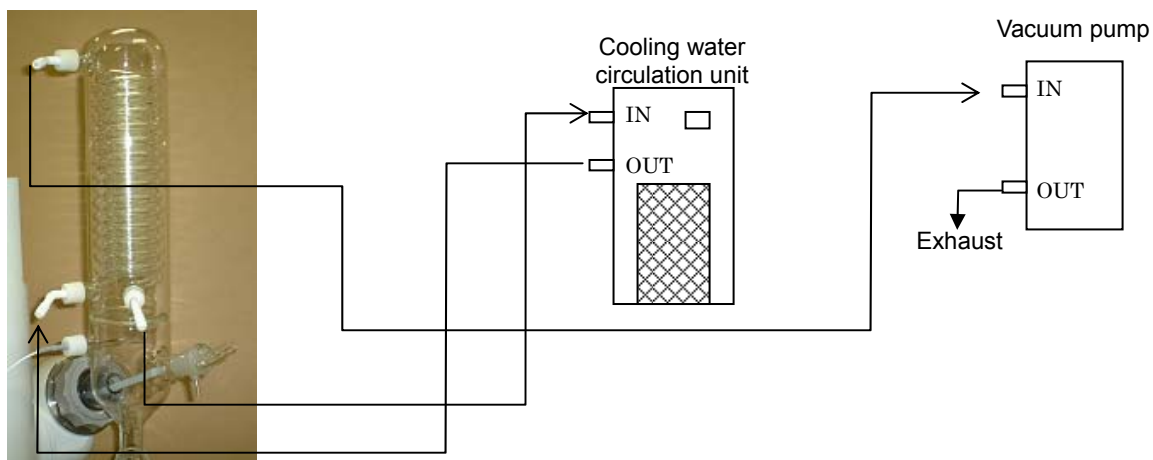

Piping method to glass set B condenser

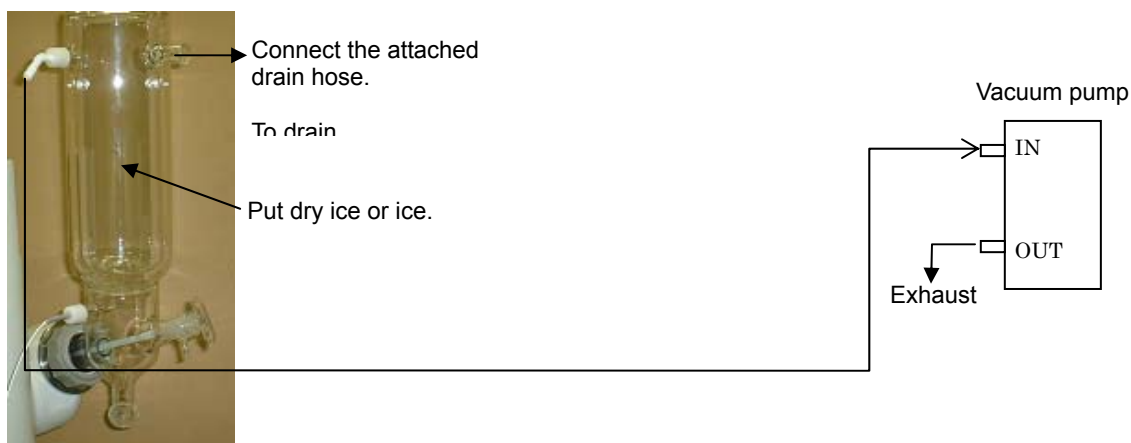

5. Installation Method

Installation Method (Optional accessories)

4) Optional accessories and their connection method

Optional accessories for rotary evaporator include VR300 model vacuum controller, TA300 model vapor temperature indicator, RT101/200 model solvent collection device, CF720, CF750, and a CF750S type cooling water circulation unit, relay hose connection fitting used on the vacuum hose or cooling water circulation hose, and glass trap to prevent back-flow.

| No. | Name | Model | Applicable model |
|-----|---|-----------|------------------|
| | | | RE301 |
| ① | VR300 model vacuum controller | VR300 | ○ |
| ② | TA300 model vapor temperature indicator | TA300 | ○ |
| ③ | RT101 model solvent collection device | RT101 | ○ |
| ④ | RT200 model solvent collection device | RT200 | ○ |
| ⑤ | CF720 and CF750 type cooling water circulation unit | CF720/750 | ○ |
| ⑥ | Hose connection fitting | ORE30 | ○ |
| ⑦ | Glass trap | ORE40 | ○ |

4) Optional accessories and their connection method①

① VR300 model vacuum controller

Refer to the VR300 model instruction manual for the connection method.

② TA300 model vapor temperature indicator

DC24V power harness is connected to RE main unit, and connect evaporation temperature sensor to the condenser.

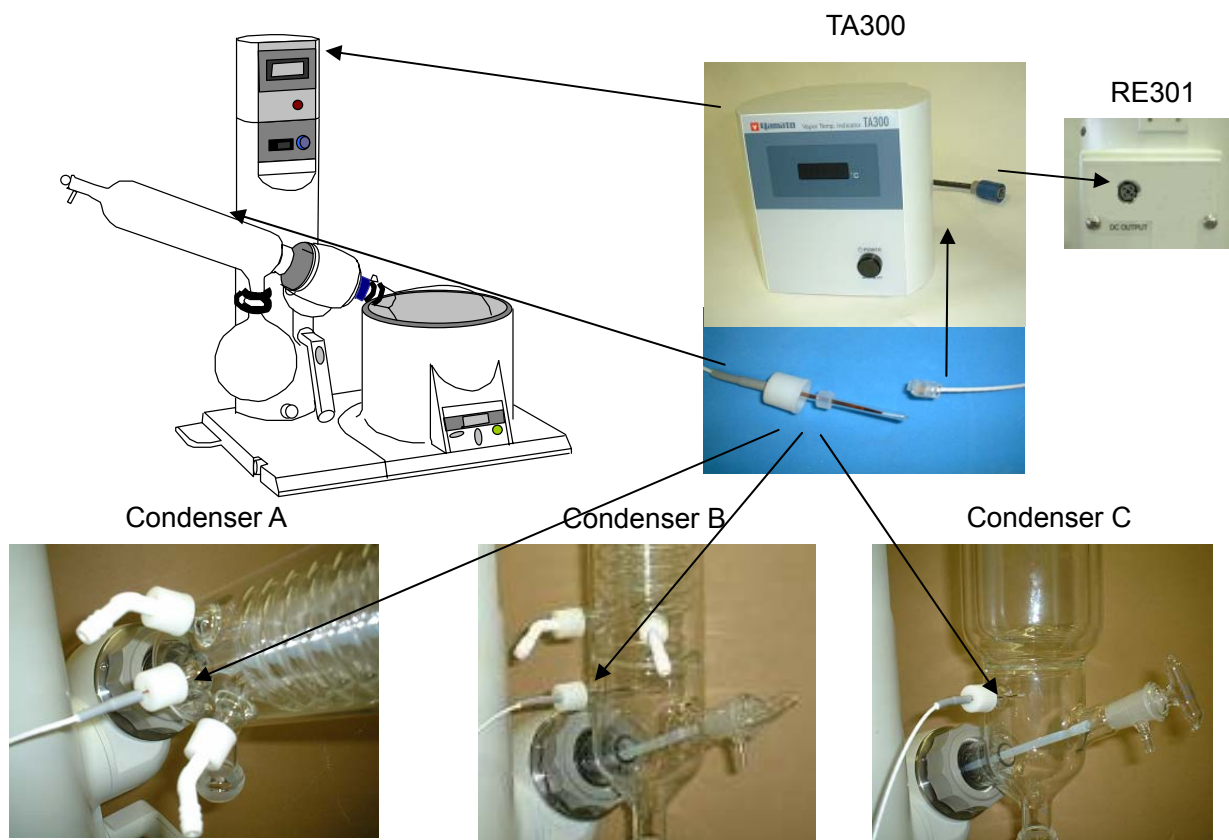

5. Installation Method

Installation Method (Optional accessories)

4) Optional accessories and their connection method②

③ RT101 model solvent collection device

Refer to the RT101 model instruction manual for the connection method.

④ RT200 model solvent collection device

The device consists of glass condenser and 500 milliliter collection flask. The device requires a cooling water circulation unit.

Connect the vacuum hose between the exhaust nozzle of vacuum pump and IN nipple on the RT200, as shown in the figure. The end connection of exhaust piping and cooling water piping on the RT200 model are placed on the back surface of main unit.

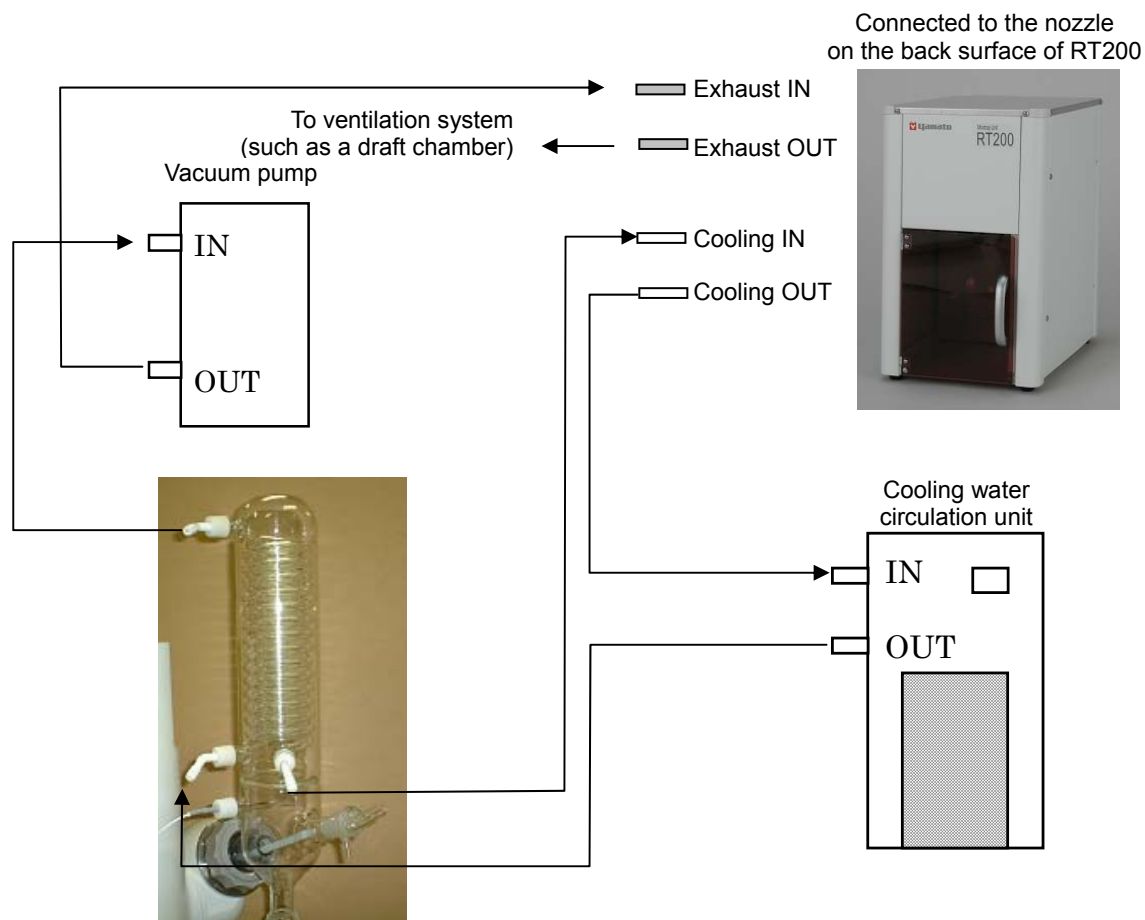

5. Installation Method

Installation Method (Optional accessories)

4) Optional accessories and their connection method③

⑤CF720 and CF750 type cooling water circulation unit

The internal piping of the unit has with two discharge ports and allows cooling in two systems(two external units).

- Carefully check the connecting piping before use.

※About the circulation pump switch

The circulation pump switch can be operated alone free of relations with the temperature controller.

Turn the breaker on, check that proper circulation is made in each pipe and that the unit is not operating with no-load, and then turn the switch “On”.

When circulation is not necessary, not only close the both cocks but also turn the switch “Off” to prolong the pump life.

※Operation and indicated data is for when only one side is used (one system is connected).

Note that the flow and the lift might decrease when both sides are used (two systems are connected) compared with when only one side is used.

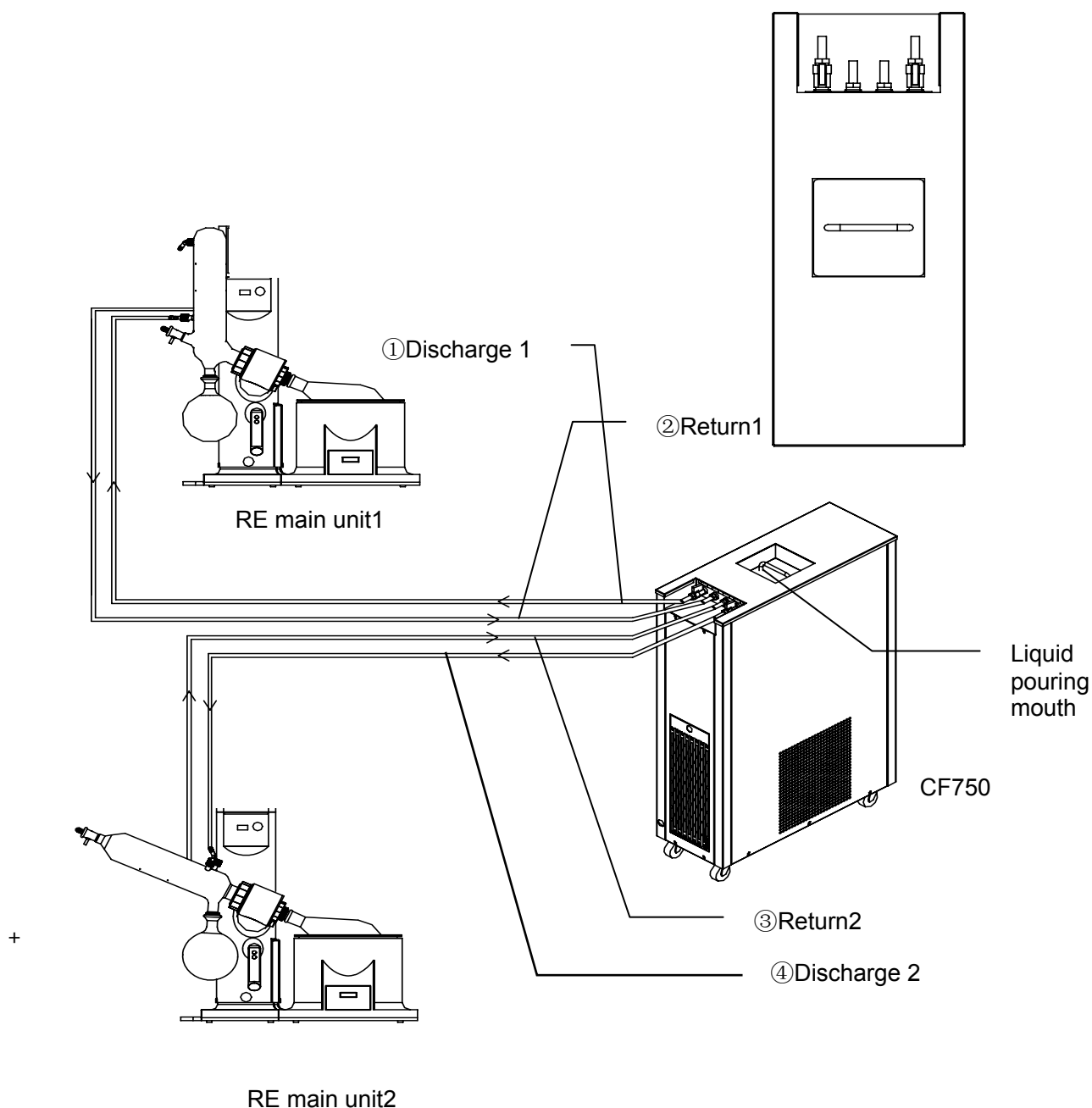

5. Installation Method

Installation Method (Optional accessories)

4) Optional accessories and their connection method④

⑥ ORE30:Piping hose connection to hose connection fitting

The nipple-fitting is used to reduce the load of vacuum hose and cooling water circulation hose, which are connected to the condenser unit on the RE main unit, at the operation of lift by supporting them.

Refer to the instruction manual of hose connection fitting for the connection method.

⑦ ORE40:Connection example of glass trap

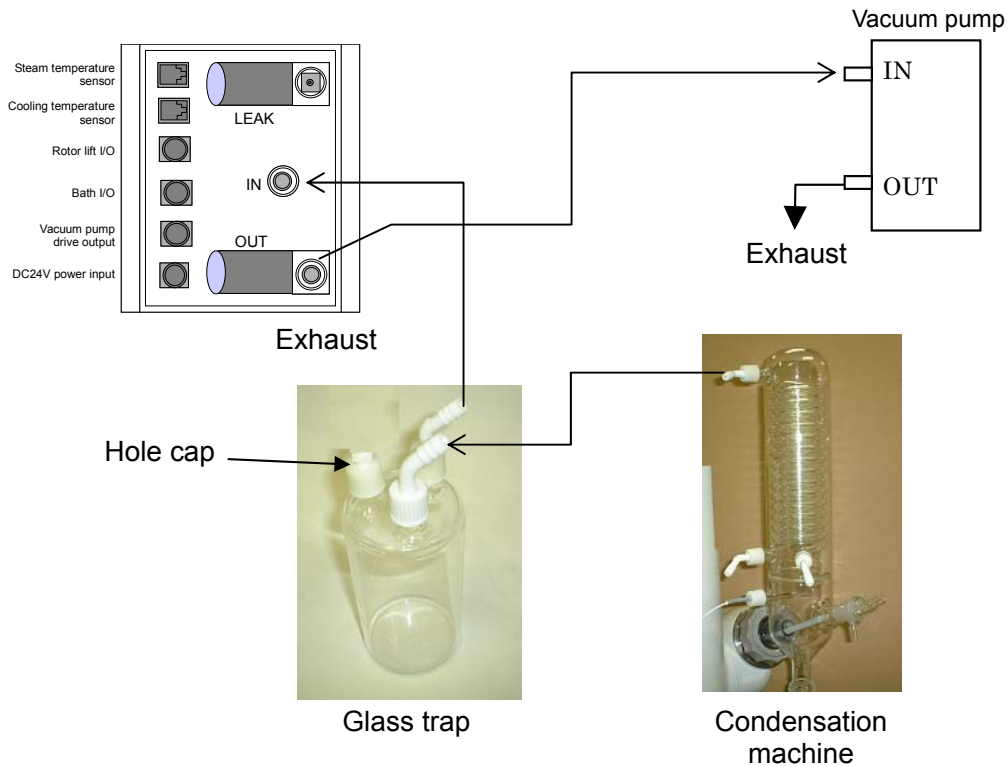

Control Panel

② Liquid crystal rotation indicator

① Rotation control knob



- Refer to the instruction manual of VR model vacuum controller for of VR model vacuum controller.
- The VR300 model vacuum controller for the RE301 model is an optional accessory. The VR300 model does not have memory function (MEMORY key).

| No. | Name | Function |
|-----|-----------------------------------|---|
| ① | Rotation control knob | The control knob equipped with the rotary motor ON/OFF switch. Clockwise rotation : Acceleration Counterclockwise rotation : Slowdown ---The condition of "OFF"--- The rotation of the motor stops when the knob is turned counterclockwise until with a clink. Factory setting, it is shipped in the state of "OFF." Maximum rotation speed: 250 rpm |
| ② | Liquid crystal rotation indicator | The indicator digital displays the rotation speed. It indicates the abnormality state when overload in motor occurs. |

7.Operation Function

Basic Operation

Flow of Basic Operation

The operation procedure of rotary evaporator is described below.

- ① Set the desired bath temperature and heat the bath until the bath temperature becomes stable.
- ② Turn on the switch of Cooling water circulation unit and circulate the cooling water.
- ③ Make sure that the rotation control knob is fully turned to the left (rotation OFF). Turn on the power switch (1 position) on the back surface of RE main unit.
- ④ Put the moderate amounts of sample into the distillation flask and connect it to the rotary joint.
- ⑤ Turn on the switch of Vacuum pump and decompression.
- ⑥ Set the desired rotation speed with the rotation control knob on the main unit. For VR300, set the desired rotation speed with the rotation control knob and then start the operation by the key operation on the VR model vacuum controller.

(Cautions: Although number of rotations is displayed from 14rpm, when using it, please use it at 20rpm or more.)

- ⑦ Lower the sample flask using the lift ∇ (down) key to heat it.

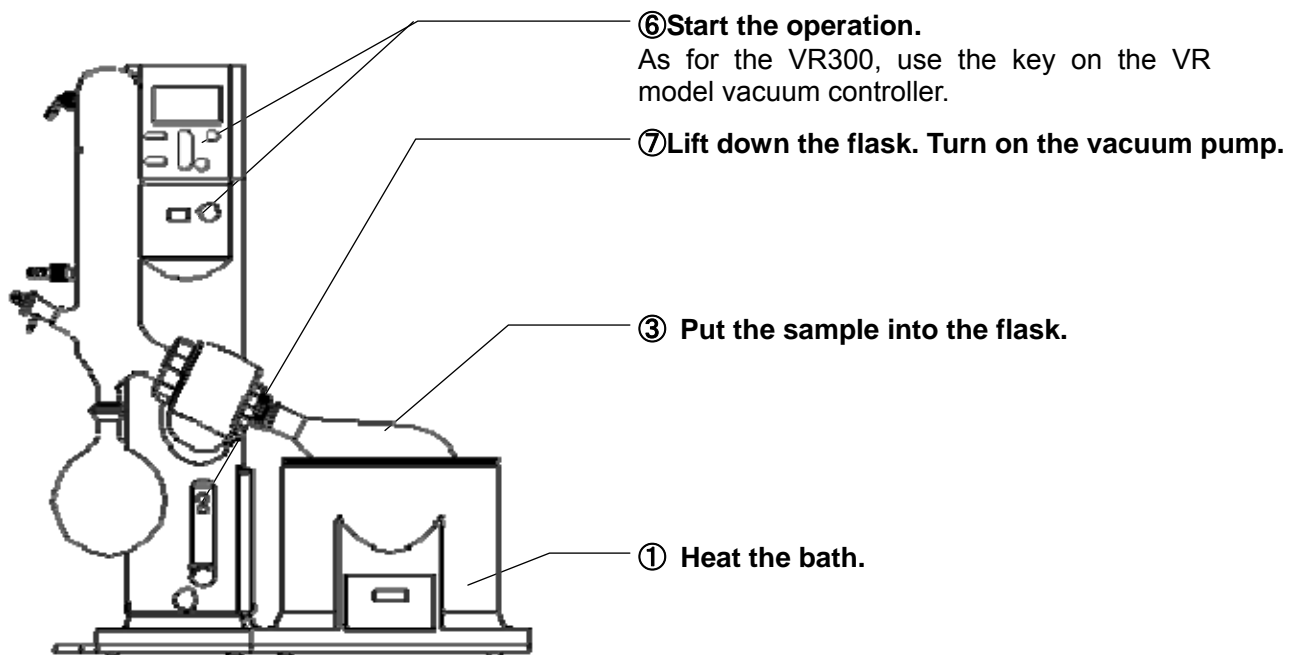

8. Description and Function of Each Part

Other Functions

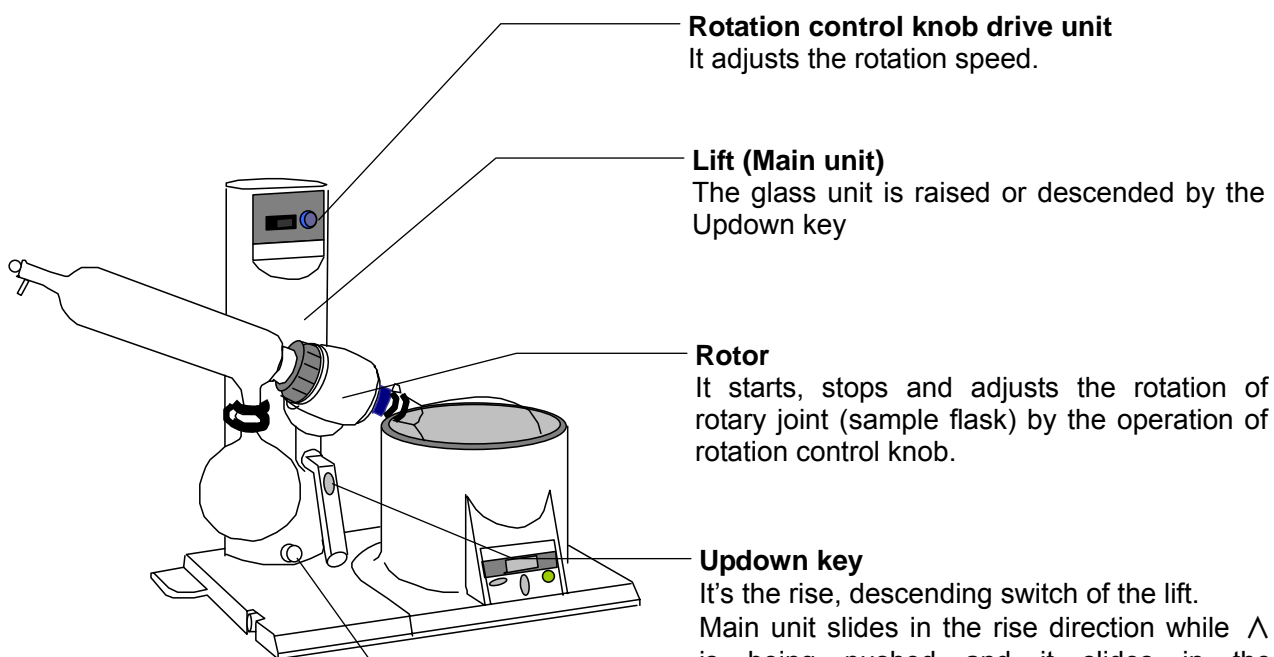

Rotation control knob drive unit
It adjusts the rotation speed.

Lift (Main unit)
The glass unit is raised or descended by the Updown key

Rotor
It starts, stops and adjusts the rotation of rotary joint (sample flask) by the operation of rotation control knob.

Updown key
It's the rise, descending switch of the lift.
Main unit slides in the rise direction while \wedge is being pushed and it slides in the descending direction while \vee is being pushed

Glass set and bath are sold separately.

Lift lower limit position control knob
It adjusts the lower limit position of lift when it is lowered. Move the lift to the uppermost position. Loosen the knob, push up to the proper position and then tighten it again to change the lowermost position of lift.



Adjuster
It is used to adjust the level of rotary evaporator.

8. Description and Function of Each Part

Other Functions

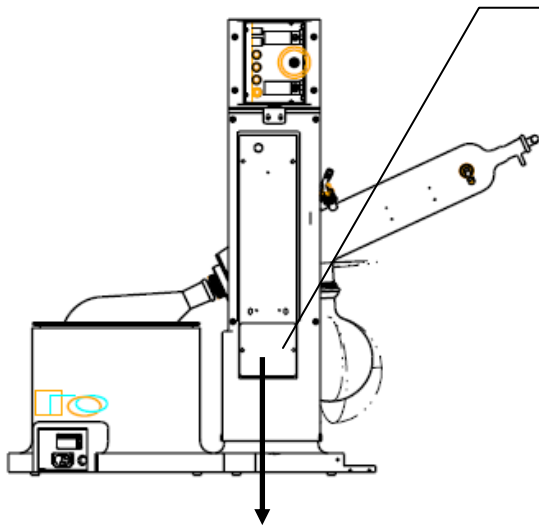

The lift up switch for the blackout

- A lift is raised when a lift switch for the blackout is pushed at the time of the blackout.
- The lift stops when a hand is left from the lift switch.
- It doesn't work even if a lift switch is pushed if it is the position of the upper limit.

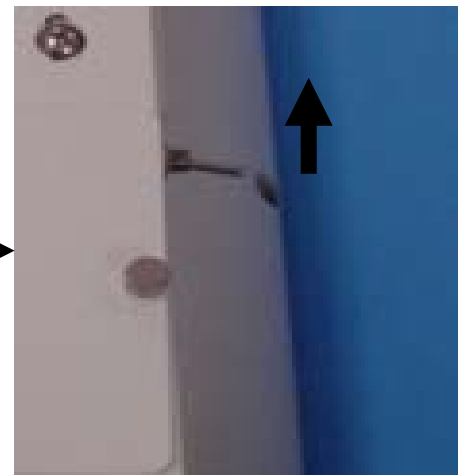

How to check a battery (9V alkaline dry cell)

- The lift is lowered with the lift down key in front of the device in the bottom position. Next, it keeps pushing a lift switch for the blackout in the rear. Confirm whether lift is raised to the upper limit within ten seconds.
- When rise time is more than ten seconds, it becomes the standard of the battery exchange time. An a little early exchange is suggested. Check a battery once a month.
- If battery use longtime, can not move lifter switch for power cut.
- Change the battery once a year regardless of use frequency.

WARNING!

- Be sure to disconnect the power cord during inspection or maintenance of device.
- Do not disassemble the device.
- Check a battery once a month.
- Change the battery once a year regardless of use frequency.

9. Handling Precautions

WARNING!

1. Substances that cannot be used

-  Never use explosive substances, flammable substances and substances that include explosive or flammable ingredients in this unit. Explosion or fire may occur. (Refer to page 34 "17. List of Dangerous Materials".)

2. If a problem occurs

-  If smoke or strange odor should come out of this unit for some reason, turn off the power key right away, and then turn off the circuit breaker and the main power. Immediately contact a service technician for inspection. If this procedure is not followed, fire or electrical shock may result. Never perform repair work yourself, since it is dangerous and not recommended.

3. Do not disassemble or modify this unit

-  Do not disassemble or modify this unit. Fire or electrical shock or failure may be caused.

4. Don't put things on Rotary Evaporator

-  If a thing is placed on a rotary evaporator, there is danger of fall. Moreover, if a solvent etc is placed, there is a possibility of becoming a cause of failure.

CAUTION!

1. During a thunder storm

-  During a thunderstorm, turn off the power switch immediately, then turn off the main power. If this procedure is not followed, fire or electrical shock may be caused.

2. Recovery after power failure

-  Turn off the power switch when a power failure occurs to avoid unmanned operation.
After a power failure return, since it is dangerous that it will be in operational status by uninhabited, please once turn off the power switch at the time of a power failure.

3. About the battery

-  Confirm the polarity of the electrode.
When an electrode is connected in the opposite direction, a problem occurs, and dangerous.
Don't mix the different kind of battery .
Remove a battery when you don't use for a long time.

10.Maintenance Method

Daily Inspection and Maintenance

For the safety use of this unit, please perform the daily inspection and maintenance without fail. Using the city water to this unit might attach dirt. Do inspect and maintain this point while performing daily inspection and maintenance.

WARNING!

- Be sure to disconnect the power cord during inspection or maintenance of device.
- Do not disassemble the device.
- Check a battery once in the moon.
- Change the battery once a year regardless of use frequency.

CAUTION!

- Wipe the dirt with soft cloth wrung out with mild detergent. Do not use benzene, thinner or cleanser, or do not scrub it with a scrubbing brush. Deformation, deterioration or discoloration may result in.

For any questions, contact the dealer who you purchased this unit from, or the nearest sales division in our company.

11. Long storage and disposal

When not using this unit for long term / When disposing

CAUTION!

When not using this unit for long term...

- Turn off the power and disconnect the power cord.
- Remove the battery stored by the equipment back.

WARNING!

When disposing...

- Keep out of reach of children.
- Remove and discard a power cord.
- Usually, discard by bulky garbage treatment.

Environmental protection should be considered

We request you to disassemble this unit as possible and recycle the reusable parts considering to the environmental protection. The feature components of this unit and materials used are listed below.

| Component Name | Material |
|-------------------------|---|
| Exterior Parts | |
| Outer covering | Aluminum printed coating, ABS resin |
| Electrical Parts | |
| Switches, Relay | Composite of resin, copper and other |
| Circuit boards | Composite of glass fiber and other |
| Power cord | Composite of resin coating, copper, nickel and other |
| Wiring material | Composite of flame-resistant vinyl, copper and nickel |
| Sticker | Resin material |
| Battery | 9V alkaline dry cell |

12.In the Event of Failure...

Safety Device and Error Code

Turn off the power and disconnect the plug immediately if the liquid leaks into the device. There is a danger of electric shock if the power is turned on after the device is dried. In this case, please call the service department of our company.

Error Code:

Check the error code and stop the operation immediately.

1.RE main unit

| Error Display | Cause/Solution |
|---------------|---|
| E04 | When abnormalities boil up on RE main unit rotor, "E04" is displayed on a screen and rotation stops. It boil up, when motor disconnection, a motor lock, and the inside temperature of a motor detect the abnormalities in overheating. From a glass set, please check whether the motor is locked and carry out resumption of after-release operation of the unusual conditions. Please carry out a service call, when you cannot cancel from a power supply re-injection. |
| E15 | When abnormalities are in a storage cell, "E15" is displayed on a screen, and equipment stops. Since it becomes board exchange when it cannot cancel from a power supply re-injection, please carry out a service call. |
| ---(Underbar) | When motor rotation speed frequency is less than 3rpm, ". . ." is displayed on a screen. If rotation speed frequency goes up, it will return automatically. |
| --- (Upbar) | When motor rotation speed frequency is 255rpm more, "- - -" is displayed on a screen. If rotation speed frequency falls, it will return automatically. |

Refer to the instruction manual of VR model for the display of abnormality on the vacuum controller.

Trouble Shooting

| Phenomenon | Check point |
|--|--|
| It does not move up and down, even if it pushes a lift up-and-down switch. | <ul style="list-style-type: none"> Is the power receptacle contained? Is the breaker set to ON? Is already a lift in the highest score? |
| It does not rotate. | <ul style="list-style-type: none"> If the rotor stops due to the overload on the rotor motor, turn off the power for about 30 minutes to cool inside the motor. Remove the cause of overheat and reduce the overload. |
| Device does not start after turning on the power switch. | <ul style="list-style-type: none"> Check if the power source is turned to on. Check if the power cable is securely plugged. Check if a power failure occurs. |
| Overload on rotor motor? | <ul style="list-style-type: none"> If the rotor stops due to the overload on the rotor motor, turn off the power for about 30 minutes to cool inside the motor. Remove the cause of overheat and reduce the overload. |

In the case if the error other than listed above occurred, turn off the power switch and primary power source immediately. Contact the shop of your purchase or nearest Yamato Scientific Service Office.

13.After Service and Warranty

When requesting a repair

When requesting a repair

If any trouble occurs, immediately stop operation, turn the ELB off, pull out the power plug and contact your dealer or our sales office.

Information necessary for requesting a repair

- Model name of the product
 - Serial number
 - Date(y/m/d) of purchase
 - Description of trouble (as in detail as possible)
- } See the warranty card or the nameplate on the unit.
} See the section "Names and Function of Parts"

Be sure to indicate the warranty card to our service representative.

Warranty card (attached separately)

- Your dealer or one of our sales offices will hand you a warranty card. Please fill necessary data such as "dealer name, date of purchase, etc" and store at a safe place.
- Warranty period is one full year from the date of purchase. Repair service for free is available according to the conditions written on the warranty card.
- For repairs after the warranty period consult your dealer or one of our sales office. Paid repair service is available on your request when the product's functionality can be maintained by repair.

Minimum holding period of repair parts

The minimum holding period of repair parts for this product is seven years after end of production.

Repair parts here refer to parts necessary for maintaining performance of the product.

14.Specification

1.RE main unit

| | | | |
|--------------------------|---|--|--|
| Model | | RE301 | |
| Configuratio n | Rotary motor | DC brushless motor with feedback control | |
| | Rotation speed | 20~250r/min | |
| | Lift motor | Rod actuator | |
| | Use surrounding temperature range | 5~35°C | |
| Performance /function | Lift stroke | 130mm | |
| | Lift function | Electrical operation and Auto | |
| | Display | Rotation unit: liquid crystal display | |
| | Setting system | Rotation unit: dial | |
| | Outer covering | ABS resin, aluminum coating finish | |
| | Setting range of vacuum degree | — | |
| | Measurement range of vacuum degree | — | |
| | Resolution of vacuum degree | — | |
| | Setting range of hysteresis | — | |
| | Indicated resolution of evaporating temperature | — | |
| | Indicated resolution of cooling water temperature | — | |
| | Operational function | — | |
| | Timer setting range | — | |
| | Memory function | — | |
| | Data operation | — | |
| | Safety function | Main unit | Circuit breaker · Rotor overload protection · Lower limit of lift by manual Lift rise switch at Blackout |
| Vacuum controller | | — | |
| Interlocking function | | — | |
| Standard | External dimension | glass set A equipped | W828 × D400 × H586 (716: at lift-up) |
| | | glass set B/C equipped | W643 × D400 × H723 (853: at lift-up) |
| | Rating | | Main unit: AC100V~240V 1.5A |
| Weight | | Approx. 14.1kg (Glass and bath not included) | |
| Accessories of main unit | | <ul style="list-style-type: none"> • Vacuum seal (1) • Rotary joint retainer (1) • O-ring (1) • Ring(large/middle/small) (each 1) • Condenser fixing nut (1) • Coil ring (1) | |
| Accessories | | <ul style="list-style-type: none"> • Bath ways (1) • Instruction manual (1) • Warranty card (1) • Battery(9V) (2) | |

15.Wiring Diagram

• RE301 main unit

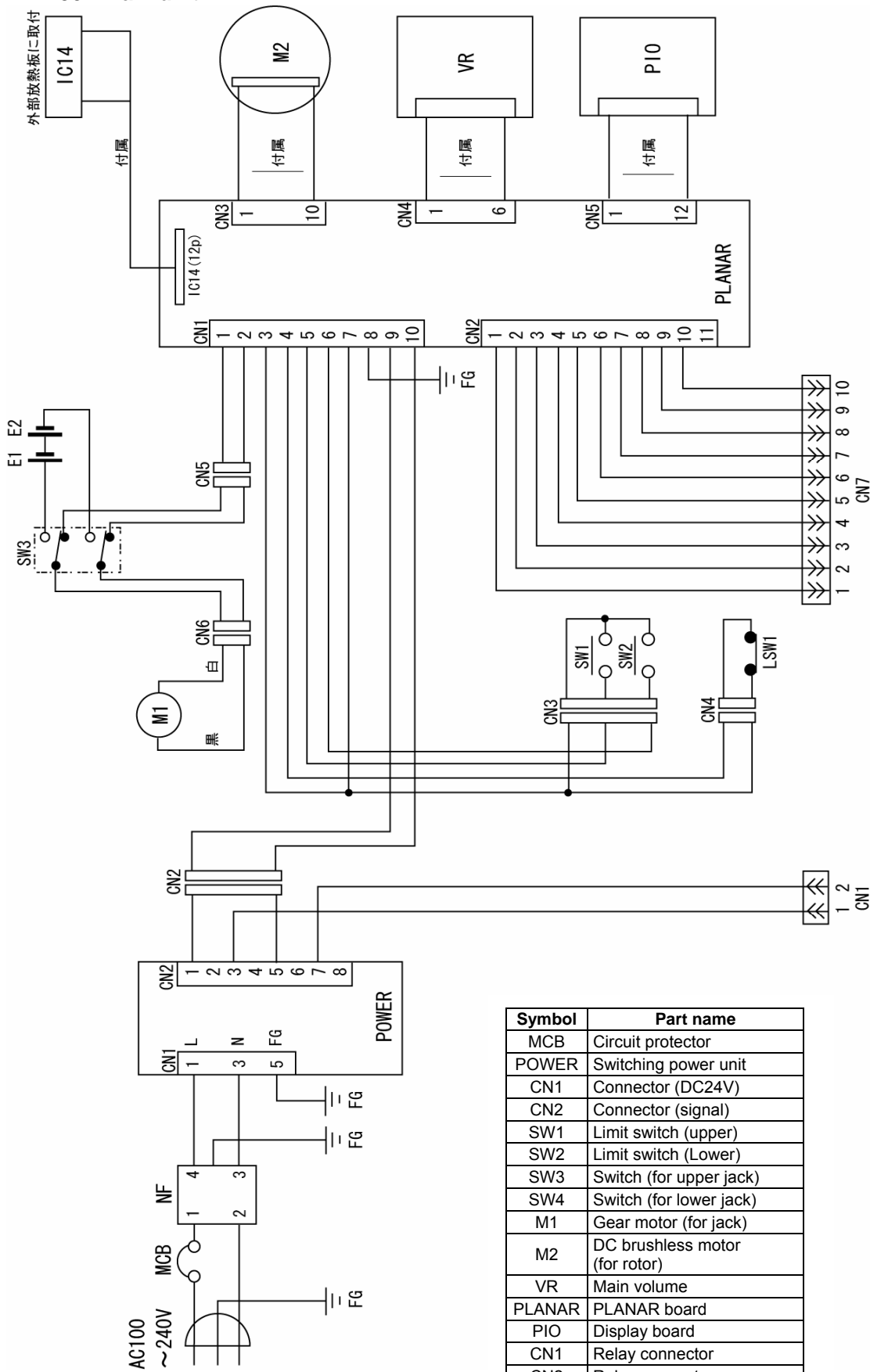

| Symbol | Part name |
|--------|--------------------------------|
| MCB | Circuit protector |
| POWER | Switching power unit |
| CN1 | Connector (DC24V) |
| CN2 | Connector (signal) |
| SW1 | Limit switch (upper) |
| SW2 | Limit switch (Lower) |
| SW3 | Switch (for upper jack) |
| SW4 | Switch (for lower jack) |
| M1 | Gear motor (for jack) |
| M2 | DC brushless motor (for rotor) |
| VR | Main volume |
| PLANAR | PLANAR board |
| PIO | Display board |
| CN1 | Relay connector |
| CN2 | Relay connector |

16.Replacement Parts Table

1.RE301 main unit

| Part Name | Code No. | Specification | Manufacturer |
|------------------------|------------|---------------|---------------------------------|
| Ring (large) | RE50040190 | | Yamato Scientific |
| Ring (middle) | LT00015384 | | Yamato Scientific |
| Ring (small) | RE50040070 | | Yamato Scientific |
| O-ring | 4210020010 | Viton P22, | Yamato Scientific |
| Rotary joint retainer | RE50040080 | | Yamato Scientific |
| Condenser mounting nut | RE50040700 | | Yamato Scientific |
| Coil ring | 2551720503 | SUS304WPA, | Yamato Scientific |
| Battery holder | LT00033690 | BH-9V-2 | TAKACHI Electricity Industry |

Refer to the instruction manual of VR model for the components of VR model.

2. Option parts

| Part Name | Code No. | Specification | Manufacturer |
|---|------------|---------------------------|-------------------|
| Teflon vacuum seal * | ORE7042000 | ORE70-42000 | Yamato Scientific |
| Flask clamp (for distillation flasks) | LT00034372 | The product made from SUS | Yamato Scientific |
| Flask clamp (for sample-receiving flasks) | RE51A0237A | The product made from SUS | Yamato Scientific |

3. Main unit related consumable part

| Part Name | Code No. | Specification | Manufacturer |
|-------------------------------|------------|--------------------------|-------------------|
| Vacuum seal | RE50040090 | RE500-40091 | Yamato Scientific |
| Flask clamp(1) | F0410001 | KC29 Black | Yamato Scientific |
| Flask clamp(2) | F0410005 | KC35 Black | Yamato Scientific |
| Nozzle Caution3 | LT00016191 | ORG10_4000_X | Ikeda Glass |
| Packing for nozzle Caution3 | LT00016192 | ORG10_4001_X | Ikeda Glass |
| Cap for nozzle Caution3 | LT00016193 | ORG10_4002_X | Ikeda Glass |
| Stop Cap for nozzles | LT00016194 | ORG10_4003_X | Ikeda Glass |
| Packing for stopping | LT00016195 | ORG10_4004_X | Ikeda Glass |
| Hose clamp | LT00016196 | | Ikeda Glass |
| Battery(9V alkaline dry cell) | LT00033689 | 6LR61XJ/2B 9V Two pieces | Panasonic |

* It is an article of consumption.

Consumable supplies related to main body

Caution:

- Use the optional Teflon vacuum seal for ketone and an ether system solvent.
Acetone, methyl ethyl ketone, methyl isobutyl ketone, ethyl ether, and MTBE (methyl t-butyl ether) etc.
-- the case where ketone and an ether system solvent are used -- vacuum seal (NBR) of standard attachment It will swell.
Use the fluorocarbon polymers vacuum seal of an option.
- See the catalog of Yamato science when you replace a glass set.
- Exchange Nozzle, Packing for nozzle and Cap for nozzle in a set.

17. List of Dangerous Materials



Never use explosive substances, flammable substances and substances that include explosive or flammable ingredients in this unit.

EXPLOSIVE

| | |
|-------------------|--|
| EXPLOSIVE: | Ethylene glycol dinitrate (nitro glycol), Glycerin trinitrate (nitroglycerine), Cellulose nitrate (nitrocellulose), and other explosive nitrate esters |
| | Trinitrobenzene, Trinitrotoluene, Trinitrophenol (picric acid), and other explosive nitro compounds |
| | Acetyl hidroperoxide (peracetic acid), Methyl ethyl ketone peroxide, Benzyl peroxide, and other organic peroxides |

FLAMMABLE

| | |
|----------------------------|---|
| IGNITING: | Lithium (metal), Potassium (metal), Sodium (metal), Yellow phosphorus, Phosphorus sulfide, Red phosphorus, Celluloid compounds, Calcium carbide, Lime phosphate, Magnesium (powder), Aluminum (powder), Powder of metals other than magnesium and aluminum, Sodium hydrosulfite |
| OXIDIZING: | Potassium chlorate, Sodium chlorate, Ammonium chlorate, and other chlorate |
| | Potassium perchlorate, Sodium perchlorate, Ammonium perchlorate, and other perchlorate |
| | Potassium peroxide, Sodium peroxide, Barium peroxide, and other inorganic peroxide |
| | Potassium nitrate, Sodium nitrate, Ammonium nitrate, and other nitrate |
| | Sodium chlorite and other chlorites |
| | Calcium hypochlorite and other hypochlorites |
| INFLAMMABLE LIQUID: | Ethyl ether, Gasoline, Acetaldehyde, Propylene chloride, Carbon disulfide, and other flammable substances having a flash point of lower than -30°C |
| | Normal hexane, ethylene oxide, acetone, benzene, methyl ethyl ketone, and other flammable substances having a flash point of -30°C or higher but lower than 0°C |
| | Methanol, Ethanol, Xylene, Pentyl acetate (amyl acetate), and other flammable substances having a flash point of 0°C or higher but lower than 30°C |
| | Kerosene, Light oil (gas oil), Oil of turpentine, Isopentyl alcohol (isoamyl alcohol), Acetic acid, and other flammable substances having a flash point of 30°C or higher but lower than 65°C |
| FLAMMABLE GAS: | Hydrogen, Acetylene, Ethylene, Methane, Propane, Butane, and other flammable substances which assume a gaseous state at 15°C and 1 atm |

(Source: Appendix Table 1 of Article 6 of the Industrial Safety and Health Order in Japan)

18. Standard Installation Manual

* Install the unit according the procedure described below (check options and special specifications separately).

| Model | Serial number | Date | Person in charge of installation (company name) | Person in charge of installation | Judgment |
|-------|---------------|------|--|----------------------------------|----------|
| | | | | | |

| No. | Item | Method | Reference operation manual | Judgment |
|-----------------------|--|---|---|----------|
| Specifications | | | | |
| 1 | Accessories | Check the quantities of accessories with the quantities shown in the Accessory column. | 14.Specification | P.31 |
| 2 | Installation | <ul style="list-style-type: none"> Visually check the surrounding area. Caution: Be careful about surrounding environment. | 3.Before Using This Unit "2. Choose a proper place for installation" | P.6 |
| | | <ul style="list-style-type: none"> Keep space. | | |
| 3 | Installation situation | <ul style="list-style-type: none"> It is checked whether load is applied to a cooling hose by the upper and lower sides of a lift. | 5.Installation Method | P.13 |
| Operation | | | | |
| 1 | Power voltage | <ul style="list-style-type: none"> Using a tester, measure the voltage of the voltage used by the customer (distribution board, outlet, etc.). Measure the voltage during operation (the voltage must be within the standard). Caution: When a unit is to be connected to the plug or breaker, use one that conforms to the standard. | 3.Before Using This Unit "1. Always ground this unit" | P.6 |
| | | | 3.Before Using This Unit "7. Choose a correct power distribution board or receptacle" | P.7 |
| | | | 14.Specification | P.31 |
| 2 | Start of operation | <ul style="list-style-type: none"> Start operation. | 7.Operation Function | P.23 |
| | | | .9.Handling Precautions | P. 26 |
| Description | | | | |
| 1 | Description of operation | Explain the operation of each unit to the customer according to this Operation Manual. | All | |
| 2 | Error code | Explain error codes and the procedure for resetting them to the customer according to this Operation Manual. | 12.In the Event of Failure... | P.29 |
| 3 | Maintenance inspection | Explain the operation of each unit to the customer according to this Operation Manual. | 10.Maintenance Method | P.27 |
| 4 | Completion of installation Information to be entered | <ul style="list-style-type: none"> Enter the date of installation and the name of the person in charge of installation on the face plate on the unit. Enter necessary information on the guarantee, and pass it to the customer. Explain the after-sale service route to the customer. | 13.After Service and Warranty | P. 30 |

Responsibility

Please follow the instructions in this document when using this unit. Yamato Scientific has no responsibility for the accidents or breakdown of device if it is used with a failure to comply. Never conduct what this document forbids. Unexpected accidents or breakdown may result in.

Note

- ◆ The contents of this document may be changed in future without notice.
- ◆ Any books with missing pages or disorderly binding may be replaced.

Instruction Manual for
Rotary Evaporator
Model RE301

Second Edition Mar. 1, 2010
Revised Jun. 24, 2013

Yamato Scientific America, Inc.
925 Walsh Ave, Santa Clara, CA 95050
Tel:408-235-7725
For technical information
and service, call: 1-800-292-6286
<http://www.yamato-usa.com>