



MV & DHK SERIES

USER MANUAL

WARNING: READ BEFORE CONTINUING

To reduce the risk of fire, electric shock or injury to persons using this freezer, read all instructions and follow basic safety precautions before using the unit, including the following:

	Do not modify the plug provided with the unit. If it will not fit the outlet, have a proper outlet installed by a qualified electrician.
	Do not position equipment so it is difficult to disconnect from the power supply.
	While under warranty, do not attempt to repair or replace any part of the freezer for servicing without first contacting the Service Department.
	BEFORE CALLING THE MANUFACTURER'S TECHNICAL SUPPORT DEPARTMENT Please have the model number of the unit, box identification number, and serial number ready as well as the problem description. The model, serial number and box id number can be found on the serial tag, which is located on the interior left upper wall, or back of the unit.

So-Low Environmental Equipment Company
10310 Spartan Drive
Cincinnati, OH 45215-1221
Tel: 513-772-9410
<http://www.so-low.com>

For customer service:
Email: sales@so-low.com

For parts replacement:
Email: parts@so-low.com

For technical support:
Email: service@so-low.com

APPLIES TO MODELS

REFRIGERATION SPECIFICATIONS

<u>REFRIGERATOR MODELS:</u>	ENERGY STAR RATED	RATED AMPS	SETPOINT TEMPERATURE RANGE	REFRIGERANT TYPE
MV4-2UCRDA	☆	.95A	2°C TO 8°C	R600A – 0.63 OZ.
MV4-2UCRGDDA	☆	1.24A	2°C TO 8°C	R290 – 0.63 OZ
MV4-6UCRDA	☆	1.66A	2°C TO 8°C	R290 – 0.92 OZ.
MV4-6UCRGDDA	☆	2.28A	2°C TO 8°C	R290 – 0.92OZ
DHK4-10GD	☆	3.83A	2°C TO 8°C	R290 – 2.12 OZ.
DHK4-14SD	☆	3.77A	2°C TO 8°C	R290 – 2.12 OZ.
DHK4-23GD	☆	5.77A	2°C TO 8°C	R290 – 3.88 OZ.
DHK4-49GD	☆	10.55A	2°C TO 8°C	R290 – 5.29 OZ.
<u>FREEZER MODELS:</u>				
MV30-4UCF	☆	1.66A	-10°C TO -25°C	R600A – 1.94 OZ.
MV40-4UCF	☆	4.19A	-20°C TO -40°C	R290 – 1.59 OZ.
DHK25-10SD	☆	2.51A	-10°C TO -25°C	R600A – 3.42 OZ.
<u>COMBINATION MODELS:</u>				
DHK-10RFC	☆	3.55A	REF: 2°C TO 8°C FRE: -10°C TO -25°C	R600A REF: 0.71 OZ. FRE: 1.59 OZ.
DHK-20RFC	☆	3.39A	REF: 2°C TO 8°C FRE: -10°C TO -25°C	R290 REF:1.09 OZ. FRE:2.12 OZ.

*SPECIFICATIONS SUBJECT TO CHANGE WITHOUT NOTICE

CONTENTS

◆ CLEARANCE & PLACEMENT INSTRUCTIONS.....	1
• PRE-INSTALLATION INFORMATION.....	1
◆ SPECIFICATIONS.....	2
◆ STARTING GUIDE & LoF ALARM.....	3
• DATA LOGGER QUICK SETTING MENU.....	3
◆ TEMPERATURE CONTROL TYPE B.....	4
◆ TEMPERATURE CONTROL TYPE A.....	5
◆ TEMPERATURE CONTROL MENU	6
◆ TEMPERATURE ALARMS.....	7
◆ MAINTENANCE, DOOR GASKET, & INDEPENDENT PROBE INSTALLATION	8
◆ WIRE DIAGRAM.....	9

CLEARANCE AND PLACEMENT INSTRUCTIONS

PRE-INSTALLATION INFORMATION

RANGE OF ENVIRONMENTAL CONDITIONS FOR WHICH THIS EQUIPMENT IS DESIGNED

- Climatic Class N
- Ambient temperature operating range: 16°C~32°C
- Humidity: 40% maximum, non-condensing.
- Electrical Supply: 110~127V/60Hz
- Altitude: 300 Meters MSL (Mean Sea Level)
- Usage: This product is intended for use indoors only

PLEASE READ ALL REQUIREMENTS BEFORE USING THIS EQUIPMENT

- 1) **Ambient Temperature** - Unlike a household refrigerator, this equipment is designed for scientific / medical application. Many components are heavy duty and extra sized, to meet the ultimate temperature performance. Therefore, the sounds generated from its operation may not be accepted by everyone in the room. Please take the operations sound factor into consideration and locate this refrigerator accordingly. Please ensure the ambient temperature is climate controlled between 60°F to 85°F to achieve the ultimate temperature performance.
- 2) **Floor Load** - The floor on which the unit is located must be even and level, free from vibrations, and strong enough to support the combined weights of the unit and maximum product load.
- 3) **Ventilation** - Grille area at front must be free and clear of any object or wall.
- 4) **Power Outlet** - Dedicated power outlet is located within the length of the unit's power cord. This is a cord-connected unit and must be connected to its own dedicated power supply. Check the data plate on the unit to confirm the voltage and per the data plate use the correct fuses or HACR circuit breakers.
- 5) **Power Cord** - This 115-volt model is equipped with a cord and 5-15P plug. Unit pre-wired at the factory. If the power cord becomes damaged, it must be replaced with an identical cord. This Unit Must Be Grounded.
- 6) **Shelf weight limit** – 40 Lbs. per shelf evenly distributed.

CAUTION



DO NOT CONNECT TO GFI / GFCI OUTLETS. CONNECTION TO THAT TYPE OF OUTLET CAN RESULT IN PRODUCT LOSS DUE TO UNSAFE CABINET TEMPERATURE WHEN GFI DEVICE TRIPS FROM MOISTURE.

DO NOT USE EXTENSION CORDS AND DO NOT DISABLE OR BY-PASS GROUND PRONG ON ELECTRICAL PLUG

SPECIFICATIONS

VOLTAGE	AMPERAGE	PLUG
<p>115 VOLTS 60 HERTZ 1 PHASE</p> <p>(SUPPLY VOLTAGE SHOULD NOT VARY MORE THAN 5% FROM SERIAL PLATE RATINGS.)</p>	<p>15 AMP <u>DEDICATED LINE</u></p>	 <p>NEMA 5-15 UNIT IS PRE-WIRED AT FACTORY</p>

OPERATIONAL TEMPERATURE RANGE

REFRIGERATOR: 1°C TO 10°C / FREEZER: -10°C TO -25°C, -20°C TO -40°C

MOISTURE DURING THE SUMMER SEASON

Due to the increase in ambient humidity in most locations during the summer season, the amount of moisture, condensation, or high humidity related issues may increase during this period.

Please note that in most cases, seasonal humidity related issues will resolve on their own when the ambient humidity levels around the unit reach under 40%.

Also, please note that the refrigeration system does not generate moisture; but instead condenses the moisture that is already in the chamber from the humidity in the air.

To prevent excess seasonal humidity related issues, please see the following.

- 1) Keeping the unit in an air conditioned, low humidity space.
- 2) Check that the door gasket is sealing properly and limit the frequency of door openings.

RELEASE OF LIABILITY

IF THIS EQUIPMENT IS BEING USED TO STORE IRREPLACEABLE AND / OR HIGH VALUE PRODUCTS, YOU (THE USER) MUST TAKE PROPER PRECAUTIONS TO ENSURE THAT PRODUCT IS NOT LOST.

SO-LOW WILL NOT BE ACCOUNTABLE FOR, CONSENT TO HAVE OBLIGATION TO, OR INHERIT RESPONSIBILITY OF PRODUCTS STORED INSIDE THE FREEZER / REFRIGERATOR REGARDLESS OF WARRANTY STATUS. THIS PERTAINS TO ANY DIRECT OR INDIRECT LOSSES (PHYSICAL OR ECONOMIC). PLEASE CONSULT THE WARRANTY OF THIS PRODUCT FOR ADDITIONAL CLARIFICATION.

Before this Refrigerator / Freezer can be placed into operation, complete all the applicable tasks listed below. You may need to consult your own departments for additional assistance with these tasks.

- 1) Connect your company remote alarm contacts system, or auto dialer, to the refrigerator's alarm system. If your model does not have an alarm system, you can install your 3rd party alarm into the access porthole on the side of the unit.
- 2) **Develop an emergency backup plan, and designate a separate back-up refrigerator, freezer, or similar appropriate device to store your product, if this equipment has an unforeseen issue.**

Starting the unit: After plugging the power cord into the outlet, on the back of the unit turn the power switch and the battery switch to the on position. The unit will then power on and the control will go through the control initialization. During this time the data recording quick setting menu is displayed and the alarm will be audible.







PLEASE NOTE THE ALARM WILL BE AUDIBLE FOR THE FIRST 60 SECONDS UPON INITIAL POWER UP AND CANNOT BE SILENCED UNTIL AFTER THE UNIT IS DISPLAYING TEMPERATURE.



(The data logger has been preset to eastern standard time.)

Take this time during the startup period to set the data logging parameters if you need to change them to your time zone, or any of the data logger settings.







To turn off the data logger change the setting SCY to 0.

Menu	Data logger quick setting menu	Range
n	Set data logger year	10~50
y	Set data logger month	1~12
r	Set data logger day	01~31
S	Set data logger hour	00~23
F	Set data logger minute	00~59
Pt	Print interval (NOT USED)	0~240
SCY	Data recording intervals. (Factory default is set to 10. Data will be recorded every 10 minutes)	0~240 0= data logger disabled

Press  or  to scroll through the menu, Press the  key to select the menu parameter you wish to change. Use the  or  to adjust the setting. Press the  key to accept the new value of the setting.

The  (set/mute) button will not be functional to silence the alarm until after the control sits idle for 60 seconds after the initial power on. Once the display switches to the current temperature inside the unit you can now silence the alarm by pressing the  set/mute button.





If the unit is displaying code “LoF”, this means the data logger needs to be started by following the below steps. (if “LoF” is not displayed, skip the below steps as the data logger is already active.)



- 1. Unlock the control by pressing the  and  buttons together for 3-4 seconds while the unit is displaying the temperature inside the unit.**
- 2. The display will read 0000, press the  button until it reads 0005**
- 3. Press the  (set/mute) button, now the control is unlocked.**
- 4. Press the  (set/mute) button and the up  for 3-4 seconds, “LoF” will then disappear, and the data logger is started.**

TEMPERATURE CONTROL - TYPE B



HOW TO UNLOCK THE CONTROL

1. Unlock the control by pressing the  and  arrow together for 3-4 seconds.
2. The display will read 0000, press the  arrow until it reads 0005.
3. Press the  (set/mute) button, now the control is unlocked.

ALARM CODES	DESCRIPTION	CONTROL BUTTONS	FUNCTION
H1	High temperature		SET / MUTE BUTTON
L1	Low temperature		UP ARROW
Do	Door open		DOWN ARROW
PF	Power Failure		PRINT (NOT USED)
BL	Low battery		
LoF	Data logger not started		

Remote alarm terminal and RS485 interface:





The remote alarm terminal is installed in the back of the refrigerator.
The terminal bearing capacity is SELV DC 30V, 2A.

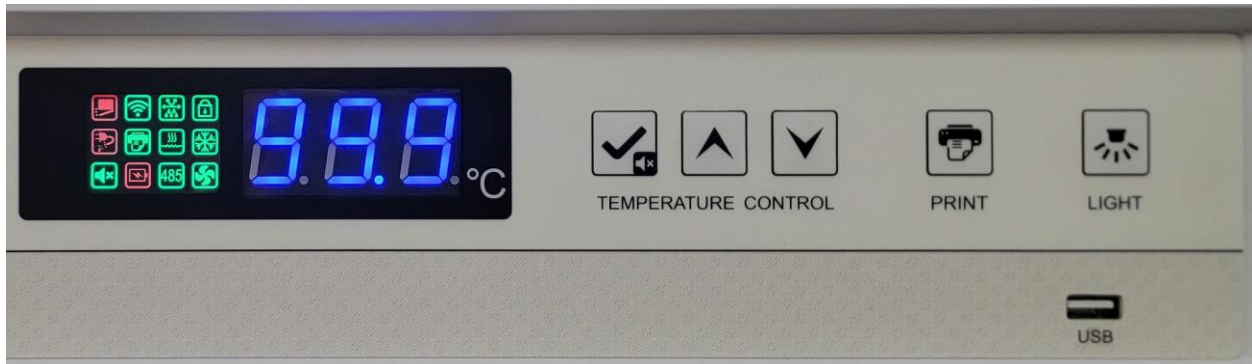

Alarm back up battery specifications - 12V Nominal Capacity (20HR) 4.0AH

TEMPERATURE CONTROL - TYPE A



HOW TO UNLOCK THE CONTROL

1. Unlock the control by pressing the  and  arrow together for 3-4 seconds.
2. The display will read 000, press the  arrow until it reads 005.
3. Press the  (set/mute) button, now the control is unlocked.

ALARM CODES	DESCRIPTION	CONTROL BUTTONS	FUNCTION
H1	High temperature		SET / MUTE BUTTON
L1	Low temperature		UP ARROW
Do	Door open		DOWN ARROW
PF	Power Failure		PRINT (NOT USED)
BL	Low battery		
LoF	Data logger not started		

Remote alarm terminal and RS485 interface:









The remote alarm terminal is installed in the back of the refrigerator.
The terminal bearing capacity is SELV DC 30V, 2A.

Alarm back up battery specifications - 12V Nominal Capacity (20HR) 4.0AH

CONTROL MENU PARAMETERS

Menu	DESCRIPTION	Range	Default
b1	Hardware version	-	-
b2	Software Version	-	-
SET	Set point of the unit	0~240	5.0
H	High Temperature alarm differential	0-10	5.0
L	Low Temperature alarm differential	0-10	5.0
Pt	Print interval (NOT USED)	0-240	20Min
tH1	High ambient temperature alarm	20.0°C-50.0°C	40.0
MAX	Highest Temperature since last cleared	-	-
MIN	Lowest Temperature since last cleared	-	-
CLR	Clear Max/Min Temperature	-	-
P1	Automatic heating mode (NOT USED)	-	-
PS1	Password setting	0000-9999	0005*

*(enter password "0099" to restore the password back to the default "0005")

1. To access the menu above, unlock the control, press  and release after 3 seconds. (Quick pressing and releasing the  button will display the ambient temperature.)
2. Press  or  to scroll through the values
3. Press the  to display the corresponding value
4. Press  or  to increase or decrease the value
5. Press the  to accept the modified value and return to the parameter menu.
6. If you need to modify other parameters in the menu, repeat steps 1-4.

To return to the main screen displaying the current temperature or you can let the control sit for 60 seconds or exit the setting menu by pressing  for 3-4 seconds.

TEMPERATURE ALARMS

Temperature Alarms: The temperature alarm will sound once the unit has been out of range for 10 minutes. Once silenced by pressing the set/mute button, the alarm will sound again if the unit is still out of range 10 minutes after silencing the alarm.

High Temperature alarm (The set point of the unit + the value of setting H = high temperature alarm setpoint) The high alarm is preset to 5. This means that the high temperature alarm will activate if the unit temperature inside the unit reaches 5 degrees higher than what the value of the setpoint is on the unit.

Low Temperature alarm: (The set point of the unit + the value of setting L = low temperature alarm setpoint) The low alarm is preset to 4. This means that the low temperature alarm will activate if the temperature inside the unit reaches 4 degrees lower than what the value is to the setpoint of the unit.

With the factory settings of SP = 5°C, L = 4, H = 5. The unit would engage low temperature alarm at 1°C. The high temperature alarm would engage at 10°C. The alarm will clear by itself once the unit gets back within the alarm range. (Any alarms will be logged in the data logger on the unit and can be downloaded in PDF form via a USB drive by plugging the USB drive into the USB port the front of the unit.

Remote alarm terminal and RS485 interface

The remote alarm terminal is installed in the back of the refrigerator.

The terminal bearing capacity is SELV DC 30V, 2A.

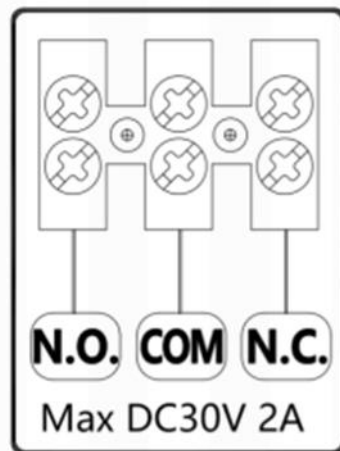

MAINTENANCE & DOOR GASKET REPLACEMENT

BEFORE PERFORMING MAINTENANCE

To reduce the risk of fire, electric shock or injury to persons using this unit, read all instructions and follow basic safety precautions.



CAUTION

DISCONNECT THIS UNIT FROM THE POWER SUPPLY BEFORE PERFORMING MAINTENANCE ON THE UNIT.

CLEANING PROCEDURE

- Wipe down the exterior of the unit with a soft cloth and spray type polish.
- If excessive ice builds up in the evaporator, the unit should be defrosted.

DEFROST PROCEDURE

1. Remove any product in the unit and store it in a back-up unit or elsewhere.
2. Unplug the unit and open the front door.
3. The evaporator drain pan will catch the water that drips from the evaporator and funnel it to the drain pan. (The drain pan may overflow depending on the amount of ice buildup.)
4. Air out the unit for 8-12 hours, allowing the unit to reach room temperature.
5. Take a rag and wipe up all the excess water in the unit.
6. After the defrost plug your unit back in.
7. Once the desired temperature is reached, add the product back into the unit.

DOOR GASKET REPLACEMENT

1. Remove existing gasket from mounting track.
2. Verify mounting track is free of any remaining gasket material.
3. Align the new gasket with the mounting track and press firmly in place.
4. Open and close the door, checking for proper gasket seal without pinching against refrigerator.

MONITOR PROBE FOR FIELD INSTALLATION

Each refrigerator or freezer is equipped with a 1/2" probe access port hole for your independent probe installation. The port hole is generally located in the back of your refrigerator or freezer. Simply remove the black cap, run your probe through, and seal the hole with black cap, or electrical putty to prevent air from getting into chamber.

DO NOT RUN YOUR PROBE THROUGH THE DOOR GASKET

Doing so may cause serious condensation or frozen evaporator issue. The port hole is specifically designed to allow you to install the monitor probe.

Circuit diagram

