

SMI INCUBATORS 100 – 120 Voltage



## Installation - Operation Manual

SMI2 SMI6 SMI7 SMI11 SMI12

Pictured on cover: SMI6



**SMI11**



**SMI12 (2 Stacked SMI6s)**



**SMI2**



**SMI7**

# SMI General Purpose Incubators 100 – 120 Voltage

## Installation and Operation Manual

Part Number: 4861572-1

Revised: March 2, 2018



SHEL LAB is a brand of Sheldon Manufacturing, INC.

## Safety Certifications

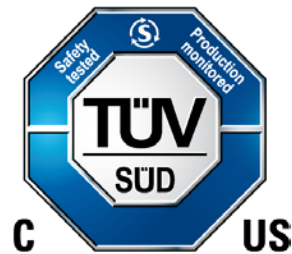

These units are CUE listed by TÜV SÜD as incubators for professional, industrial, or educational use where the preparation or testing of materials is done at an ambient air pressure range of 22.14 – 31.3 inHg (75 – 106 kPa) and no flammable, volatile, or combustible materials are being heated.

These units have been tested to the following requirements:

- CAN/CSA C22.2 No. 61010-1:2012
- CAN/CSA C22.2 No. 61010-2-010 + R:2009
- UL 61010A-2-010:2002
- UL 61010-1:2012
- EN 61010-1:2010
- EN 61010-2-010:2003

# TABLE OF CONTENTS

<b>INTRODUCTION .....</b>	<b>5</b>
<i>Read this Manual.....</i>	5
<i>Safety Considerations and Requirements .....</i>	5
<i>Contacting Assistance .....</i>	6
<i>Temperature Reference Sensor Device .....</i>	6
<i>Engineering Improvements.....</i>	6
<b>RECEIVING YOUR UNIT .....</b>	<b>7</b>
<i>Inspect the Shipment.....</i>	7
<i>Recording Data Plate Information .....</i>	8
<b>INSTALLATION .....</b>	<b>9</b>
<i>Installation Procedure Checklist .....</i>	9
<i>Required Ambient Conditions.....</i>	10
<i>Required Clearances.....</i>	10
<i>Environmental Disruption Sources.....</i>	10
<i>Power Source Requirements .....</i>	11
<i>Lifting and Handling .....</i>	12
<i>Leveling.....</i>	12
<i>Install Incubator in Location .....</i>	12
<i>Installation Cleaning.....</i>	12
<i>Deionized and Distilled Water.....</i>	13
<i>Install the Shelving.....</i>	13
<i>Access Port .....</i>	13
<b>GRAPHIC SYMBOLS .....</b>	<b>15</b>
<b>CONTROL PANEL OVERVIEW .....</b>	<b>17</b>
<b>OPERATION.....</b>	<b>19</b>
<i>Theory of Operation .....</i>	19
<i>Put the Incubator into Operation .....</i>	20
<i>Set the Incubator Temperature Set Point.....</i>	21
<i>Set the Over Temperature Limit.....</i>	22
<i>Loading Samples.....</i>	23
<i>Chamber Accessory Power Outlets .....</i>	23
<i>Humidifying the Incubator.....</i>	23
<i>Condensation and the Dew Point .....</i>	24
<b>USER MAINTENANCE.....</b>	<b>25</b>
<i>Cleaning and Disinfecting.....</i>	25
<i>Minimizing Contamination Exposure .....</i>	26
<i>Storing the Incubator.....</i>	27
<i>Door Components.....</i>	27
<i>Electrical Components .....</i>	27
<i>Calibrate the Temperature display.....</i>	28
<b>UNIT SPECIFICATIONS .....</b>	<b>33</b>
<i>Weight.....</i>	33
<i>Dimensions.....</i>	33
<i>Capacity .....</i>	34
<i>Temperature .....</i>	34
<i>Power.....</i>	34
<b>PARTS LIST.....</b>	<b>35</b>
<i>Ordering Parts and Consumables .....</i>	35

# INTRODUCTION

*Thank you for purchasing a SHEL LAB Incubator. We know you have many choices in today's competitive marketplace when it comes to constant temperature equipment. We appreciate you choosing ours. We stand behind our products and will be here for you if you need us.*

## ***READ THIS MANUAL***

Failure to follow the guidelines and instructions in this user manual may create a protection impairment by disabling or interfering with the unit safety features. This can result in injury or death.

Before using the unit, read the manual in its entirety to understand how to install, operate, and maintain the unit in a safe manner. Keep this manual available for use by all operators. Ensure all operators are given appropriate training before the unit begins service.

## ***SAFETY CONSIDERATIONS AND REQUIREMENTS***

Follow basic safety precautions, including all national laws, regulations, and local ordinances in your area regarding the use of this unit. If you have any questions about local requirements, please contact the appropriate agencies.

### **SOPs**

Because of the range of potential applications, this unit can be used for, the operator or their supervisors must draw up a site-specific standard operating procedure (SOP) covering each application and associated safety guidelines. This SOP must be written and available to all operators in a language they understand.

### **Intended Applications and Locations**

The incubators are intended for constant temperature, non-humidified general incubation applications in professional, industrial, and educational environments. The units are not intended for use at hazardous or household locations.

### **Power**

Your unit and its recommended accessories are designed and tested to meet strict safety requirements.

- The unit is designed to connect to a power source using the specific power cord type shipped with the unit.
- Always plug the unit power cord into a protective earth grounded electrical outlet conforming to national and local electrical codes. If the unit is not grounded properly, parts such as knobs and controls can conduct electricity and cause serious injury.
- Do not bend the power cord excessively, step on it, or place heavy objects on it.
- A damaged cord can be a shock or fire hazard. Never use a power cord if it is damaged or altered in any way.
- Use only approved accessories. Do not modify system components. Any alterations or modifications to your unit can be dangerous and void your warranty.

# INTRODUCTION

## *CONTACTING ASSISTANCE*

Phone hours for Sheldon Technical Support are 6 am – 4:30 pm Pacific Coast Time (west coast of the United States, UTC -8). Please have the following information ready when calling or emailing Technical Support: the **model number** and the **serial number** (see page 8).

EMAIL: support@sheldonmfg.com

PHONE: 1-800-322-4897 extension 4, or (503) 640-3000

FAX: (503) 640-1366

Sheldon Manufacturing, INC.

P.O. Box 627

Cornelius, OR 97113

## *TEMPERATURE REFERENCE SENSOR DEVICE*



This unit does not come with a temperature reference device. **A reference device must be purchased separately** for performing in-house accuracy validations or calibration adjustments of the incubator temperature display.

The device must be accurate to at least 0.1°C and should be regularly calibrated by a third party. For best results, use a digital device with one or more thermocouple probes. Remote readings eliminate chamber door openings and avoid subsequent waits for the chamber temperature to re-stabilize. Select probes suitable for the application temperature you will validate or correct the display accuracy at.

Alcohol thermometers are insufficient for conducting accurate validations and calibrations. Do not use a mercury thermometer. **Never place a mercury thermometer in the incubation chamber.** Always use thermocouple probes.

## *ENGINEERING IMPROVEMENTS*

Sheldon Manufacturing continually improves all of its products. As a result, engineering changes and improvements are made from time to time. Therefore, some changes, modifications, and improvements may not be covered in this manual. If your unit's operating characteristics or appearance differs from those described in this manual, please contact your SHEL LAB dealer or customer service representative for assistance.

# RECEIVING YOUR UNIT

## *INSPECT THE SHIPMENT*

- When a unit leaves the factory, safe delivery becomes the responsibility of the carrier.
- Damage sustained during transit is not covered by the manufacturing defect warranty.
- Save the shipping carton until you are certain that the unit and its accessories function properly

When you receive your unit, inspect it for concealed loss or damage to its interior and exterior. If you find any damage to the unit, **follow the carrier's procedure for claiming damage or loss.**

1. Carefully inspect the shipping carton for damage.
2. Report any damage to the carrier service that delivered the unit.
3. If the carton is not damaged, open the carton and remove the contents.
4. The unit should come with an Installation and Operation Manual.
5. Verify that the correct number of accessory items have been included.

### Included accessories

Model	Shelves	Shelf Slides	Leveling Feet	Power Cord
SMI2, SMI7	2	4	4	1
SMI6	3	6	4	1
SMI11	6	12	4	1
SMI12	6	12	4	2

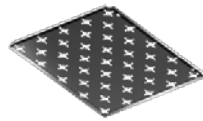

6. Carefully check all packaging for accessories before discarding.

# RECEIVING YOUR UNIT

## *RECORDING DATA PLATE INFORMATION*

The data plate contains the incubator **model number** and **serial number**. Tech Support will need this information during any support call. Record it below for future reference.

- The data plate is located on the top right corner of the incubation chamber door interior.

<b>Model Number</b>	
<b>Serial Number</b>	



## *INSTALLATION PROCEDURE CHECKLIST*

Carry out the procedures and steps listed below to install the incubator in a new workspace location and prepare it for use. All procedures are found in the Installation section of this manual.

### **Pre-Installation**

- ✓ Check that the required ambient condition for the unit are met, page 10
- ✓ Check that the spacing clearance requirements are met, page 10
  - Unit dimensions may be found on page 33
- ✓ Check for performance-disrupting heat and cold sources in the environment, page 10
- ✓ Check that a suitable electrical outlet and power supply is present, page 11

### **Install the Incubator in a suitable workspace location**

- ✓ Review the lifting and handling instructions, page 12
- ✓ Make sure the incubator is level, page 12
- ✓ Install the incubator in its workspace location, page 12

### **Set up the Incubator for use**

- ✓ Clean and disinfect the unit and shelving (recommended), page 12
- ✓ Install the shelving, page 13
- ✓ Verify the port cover has been installed on the access port, page 13

# INSTALLATION

## REQUIRED AMBIENT CONDITIONS

These units are intended for use indoors, at room temperatures between **15°C and 30°C (59°F and 86°F)**, at no greater than **80% Relative Humidity** (at 25°C / 77°F).

Operating these units outside of these conditions may adversely affect its incubator temperature stability and effective operating range. For conditions outside of those listed above, please contact your SHEL LAB distributor to explore other options suited to your laboratory or production environment.

## REQUIRED CLEARANCES

These clearances are required to provide air flows for ventilation and cooling.

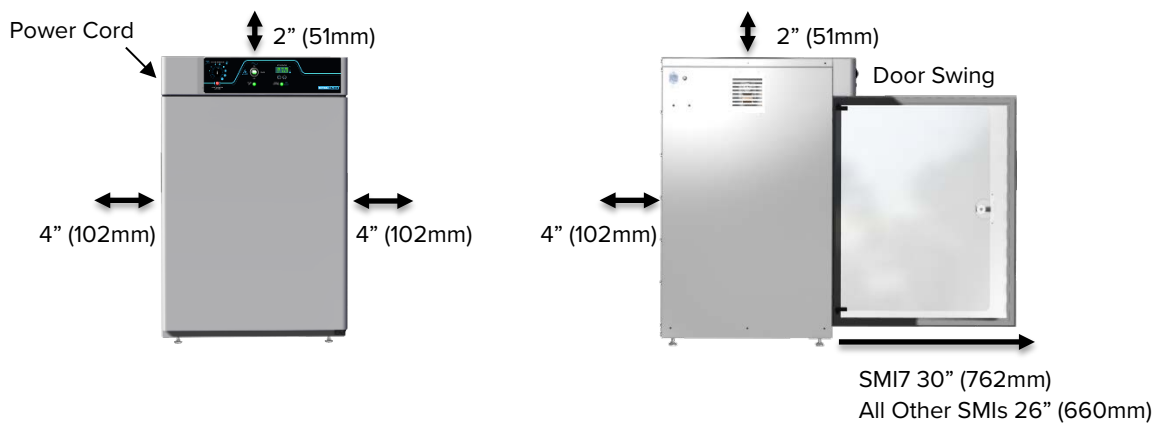

**4 inches (102mm)** of clearance is required on the sides and back.

**2 inches (51mm)** of headspace clearance between the top of the unit and any overhead partitions.

## ENVIRONMENTAL DISRUPTION SOURCES

Consider proximate environmental factors that can affect the chamber temperature and atmospheric integrity when selecting a location to install the unit:

- Ovens, autoclaves, and any device that produces significant radiant heat
- High-traffic areas
- Direct sunlight
- Heating and cooling ducts, or other sources of fast-moving air currents

# INSTALLATION

## POWER SOURCE REQUIREMENTS

When selecting a location for the unit, verify each of the following requirements is satisfied.

**Power Source:** The power source for the unit must match the voltage and match or exceed the ampere requirements listed on the unit data plate. These units are intended for **100 - 120V 50/60 Hz** applications at the following amperages:

Model	Amperage	Model	Amperage
SMI2	4.5 Amps	SMI7	6.5 Amps
SMI6	6.0 Amps	SMI11	7.0Amps

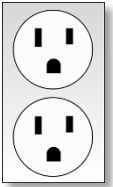

Standard  
NEMA 5-15R  
wall socket

The SMI12 requires comes with two power cords. It requires **6.0 amps** for each cord.

- **Supplied voltage must not vary more than 10% from the data plate rating.** Damage to the unit may result if supplied voltage varies more than 10%.
- The wall power source must be protective earth grounded.
- Use a separate circuit to prevent loss of the unit due to overloading or circuit failure.
- **The recommended wall circuit breakers for these units are 15 amps.**
- The wall power source must conform to all national and local electrical codes.

**Power Cord:** The unit must be positioned so that all end-users can quickly unplug the cord in the event of an emergency.

- Each unit comes provided with a **125 volt, 15 Amp, 9ft 5 in (2.86m) NEMA 5-15P** power cord. Always use this cord or an identical replacement.



**Fuses:** These units each ship with a fuse installed in the power cord inlet.

- The fuse must be installed and intact for the unit to operate.
- Always find and fix the cause of a blown fuse prior to putting the unit back into operation.
- Fuse types
  - SMI7 and SMI11 - 250V T10 amp, 5x20mm
  - SMI2, SMI6, SMI12 - 250V T6.3A, 5x20mm

# INSTALLATION

## *LIFTING AND HANDLING*

The unit is heavy. Use appropriate lifting devices that are sufficiently rated for these loads. Follow these guidelines when lifting the unit.

- Lift the unit only from its bottom surface.
- Doors, handles, and knobs are not adequate for lifting or stabilization.
- Restrain the unit completely while lifting or transporting so it cannot tip.
- Remove all moving parts, such as shelves and trays, and lock doors in the closed position during transfers to prevent shifting and damage.

## *LEVELING*

Install the 4 leveling feet with the 4 corner holes on the bottom of the unit. The unit must be level and stable for safe operation.

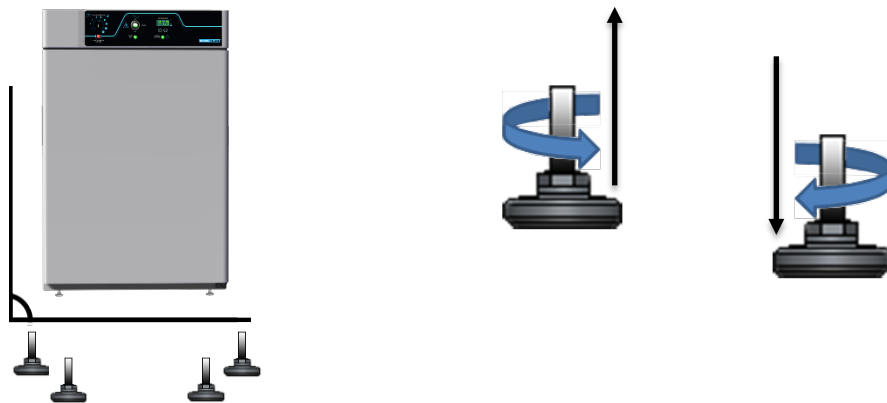

---

**Note:** To prevent damage when moving the unit, turn all four leveling feet so that the leg of each foot sits inside the unit.

---

## *INSTALL INCUBATOR IN LOCATION*

Install the unit in a workspace location that meets the criteria discussed in the previous entries of the Installation section.

## *INSTALLATION CLEANING*

Cleaning and disinfecting the incubation chamber during installation reduces the chance of microbiological contamination. The unit was cleaned and disinfected at the factory. However, the unit may have been exposed to contaminants during shipping. Additionally, the factory procedure may not meet the standards of your institutional protocols. Please see the [Cleaning and Disinfecting](#) entry on page 25 in the User Maintenance section for information on how to clean and disinfect without damaging the chamber.

- Remove all wrappings and coverings from shelving prior to cleaning and installation.

# INSTALLATION

## *DEIONIZED AND DISTILLED WATER*

**Do not use deionized water** to clean or humidify the incubator. Use of deionized water may corrode metal surfaces and voids the warranty. The manufacturer recommends the use of distilled water in the resistance range of 50K Ohm/cm to 1M Ohm/cm, or a conductivity range of 20.0 uS/cm to 1.0 uS/cm, for cleaning and humidifying applications.

## *INSTALL THE SHELVING*

To install the incubator shelves perform the following:

1. Hold the shelf slide at about a 10° angle. See figure 2A
2. Insert the hooked tab into the vertical slot at the desired height (Figure 2B)).
3. Push the slide into the horizontal slots.
4. Repeat for shelf slide at the same height on the opposite side of the incubator.
5. Place a shelf on the shelf slides. Repeat this procedure for additional shelves as needed.

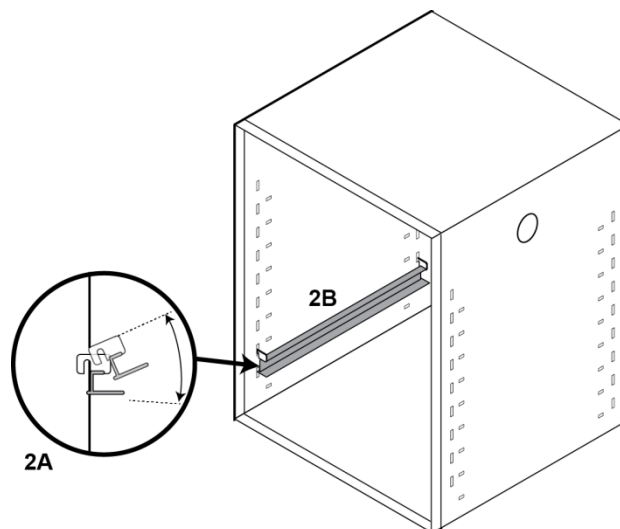

**Shelving Installation**

## *ACCESS PORT*





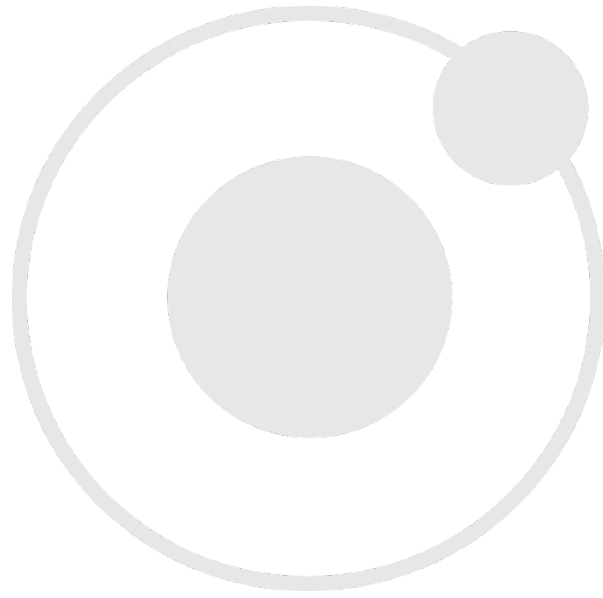



SMI incubators are provided with a plastic cap for the access port on the right side of the incubation chamber. Always leave this cap in place, except when introducing sensor probes into the chamber, such as those used for temperature calibrations. Removing the cap during normal operations can adversely impact temperature stability and uniformity.



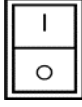

# GRAPHIC SYMBOLS

The unit is provided with multiple graphic symbols on its exterior. The symbols identify hazards and the functions of the adjustable components, as well as important notes in the user manual.

Symbol	Definition
	Consult the user manual. Consulter le manuel d'utilisation
	Temperature display Indique l'affichage de la température
	Over Temperature Limit system Thermostat température limite contrôle haute
	AC Power Repère le courant alternatif
	I/ON O/OFF I indique que l'interrupteur est en position marche. O indique que le commutateur est en position d'arrêt.
	Protective earth ground Terre électrique
	Indicates UP and DOWN respectively Touches de déplacements respectifs vers le HAUT et le BA
	Manually adjustable Indique un réglage manuel
	Recycle the unit. Do not dispose of in a landfill. Recycle l'unité. Ne jetez pas dans une décharge.

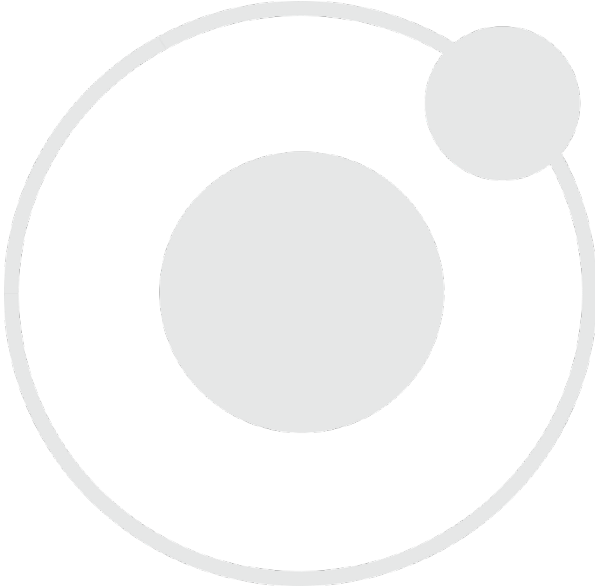



# CONTROL PANEL OVERVIEW



Figure 1: Control Panel

## Over Temperature Limit Control (OTL)

The Set Over Temperature dial sets the temperature limit at which the incubator cuts off heating in the incubation chamber. The red Over Temp Activated light illuminates when the OTL system is rerouting power away from the heating elements. For more details, please see [the Over Temperature Limit System](#) description in the Theory of Operations (page 19).



## Power Switch

The power switch controls all power to each incubator and its systems. The green Power On light should illuminate when the switch is in the I (on) position.



## Temperature Control and Display

During normal operations, the display shows the current incubator air temperature, accurate to 0.1°C. The Up and Down buttons are used to change display modes and then input either a new temperature set point or a calibration adjustment. The display blinks continually while in its set point or calibration adjustment modes, preceded by an “SP” for Set Point or “C O” for Calibration Offset.



The Heating indicator light illuminates when the incubator powers the chamber heating elements.



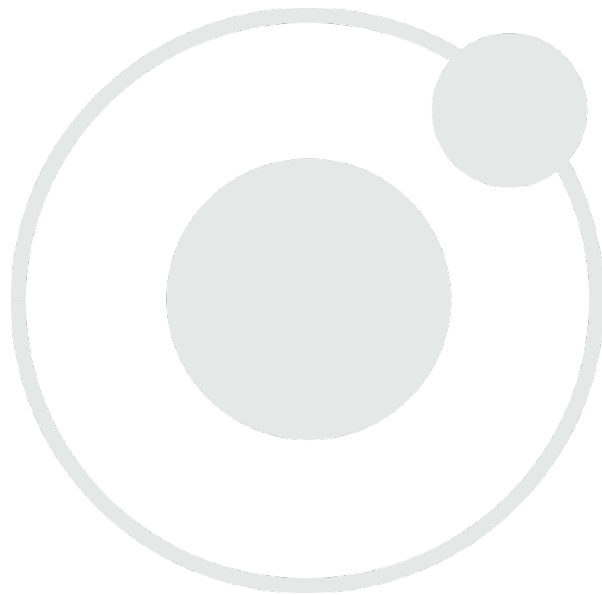

## *THEORY OF OPERATION*

The SMI general purpose incubators are engineered to provide constant temperature incubation environments. Each unit can obtain a stable, uniform temperature in its chamber, ranging from the room temperature (ambient) +8°C up to 70°C for incubation applications. Each incubator features an inner glass viewing door that allows visual inspection of samples without compromising the chamber temperature environment. Each incubator unit in a SMI12 is independently powered and heated.

### **Heating**

Each incubator is controlled by a microprocessor board with heating elements attached to the incubation chamber walls and a solid-state temperature sensor probe inside the chamber. The processor employs proportional-integral-derivative analytical feedback-loop functions when measuring and controlling the chamber air temperature. PID-controlled heating pulse intensities and lengths are proportional to the difference between the measured chamber temperature and the set point. The set point is the desired operating temperature entered by the user. The frequency of pulses is derived from the rate of change in the difference. The integral function slows the rate of pulses when the temperature nears the set point in order to prevent overshooting.

The PID functions are also used to optimize incubator warming rates for hotter or cooler environments. Heat loss from leaving the incubator doors open for long periods of time (an hour or more) can trick the controller into operating as though in a cool environment. This can result in a period of temperature overshoots.

Each incubator relies on natural heat radiation for cooling. An incubator can achieve a low-end temperature of the ambient room temperature +8°C. The fan inside in the incubator aids in maintaining air circulation and a uniform air temperature in the incubation space.

The chamber door is self-heating to bolster the thermal uniformity and stability of the chamber and to minimize condensation on the glass viewing door. The glass door will cool while the chamber door is opening, eventually leading to condensate on the door and impacting the chamber temperature stability and uniformity. Minimize sample viewing times when possible.

### **The Over Temperature Limit System**

The OTL is a mechanical heating cutoff included with each incubator and operates independently of the incubator microprocessor controller. The OTL helps safeguard samples by preventing runaway heating in the event of a hardware failure in the microprocessor controller or a sudden external heat spike. The OTL is connected to a hydrostatic sensor probe located inside the incubator and is intended to be set by the user to approximately 1°C above the current operating temperature set point.

If the incubator temperature exceeds the OTL cutoff setting, the OTL will route power away from the incubator heating elements. It will continue to do so as long as the incubator air temperature is higher than the present OTL cutoff setting. A red indicator illuminates when the OTL is rerouting power.

# OPERATION

## PUT THE INCUBATOR INTO OPERATION

Carry out the following steps and procedures to put the unit into operation after installing it in a new workspace environment.

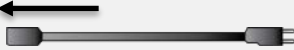
1.  Attach the power cord that came with the unit to the power inlet receptacle on the side of the incubator.

2.  Plug the power cord into the workspace electrical supply outlet.

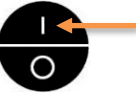
3.  Place the incubator **Power Switch** in the on ( I ) position.

- The Power light illuminates
- The Temperature display illuminates

4.  **Set the Temperature the Set Point** to your incubation application temperature.

- See page 21

5.  **Set the Over Temperature Limit.** See page 22.

The incubator must be heated **and stable** at your application temperature to perform this procedure.



Wait 8 Hours

Allow the unit to run 8 hours (overnight) prior to:

- **Loading Samples**, page 23
- Verifying the accuracy or calibrating the incubator temperature display.

End of procedure

# OPERATION

## SET THE INCUBATOR TEMPERATURE SET POINT

**SMI12:** Each incubator must be set independently.

1. Set the OTL control to its maximum setting, if not already set to max.

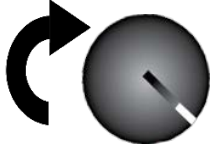

- Turning the OTL all the way to the right (clockwise) prevents the heating cutoff system from interfering with setting a higher temperature.

2. Jump to the Temperature Set Point Adjustment mode



Press and hold either

Set Temperature



Set Point Adjustment Mode

Set Temperature



Initial Set Point

**Note:** The display will automatically exit the adjustment mode after 5 seconds of inactivity on the arrow keys, saving the last shown set point value.

3. Set the Temperature Set Point

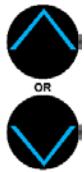

Adjust



New Set Point

**Note:** To turn an incubator off, set the set point to its lowest setting (OFF).

4. Wait for 5 seconds after entering the Set Point



Wait 5 Seconds

Set Temperature



HEATING ACTIVATED

- The display will stop flashing. The set point is now saved in the controller.
- The display will revert to showing the current chamber air temperature, heating or passively cooling to match the new set point.

See the next page for how to set the Over Temperature Limit heating cutoff.

End of procedure

# OPERATION

**Note:** Test the OTL heating cutoff system at least once per year for functionality.

## *SET THE OVER TEMPERATURE LIMIT*

The incubator must be operating at your incubation application temperature and must be stable for at least 1 hour prior to setting the OTL. Each incubator OTL must be set independently in the SMI12.

**1. Set OTL control to its maximum setting, if not already set to max.**

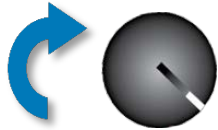

**2. Turn the dial counterclockwise until the red Over Temperature Limit Light illuminates.**



**3. Slowly turn the dial clockwise until the OTL Activated light turns off.**



- The Over Temperature Limit is now set approximately 1°C above the current incubator air temperature.

**4. Leave the OTL dial set just above the activation point.**



**Optional: Turn the dial slightly to the left.**



- This sets the OTL cutoff threshold nearer to the current incubator air temperature.

If the OTL is sporadically activating, you may turn the dial slightly to the right (clockwise).

If the OTL continues activating, check for ambient sources of heat or cold that may be adversely impacting the unit temperature stability. Check if any powered accessories in the workspace chamber are generating heat. If you can find no sources of external or internal temperature fluctuations, contact Tech Support or your distributor for assistance.

End of Procedure

# OPERATION

## *LOADING SAMPLES*

Place items on the shelves inside the incubation chamber as evenly spaced as possible. Proper spacing allows for maximum air circulation and a high degree of temperature uniformity. Leave 1 inch (2.5cm) between sample containers and the chamber walls.

## *CHAMBER ACCESSORY POWER OUTLET*

These incubators are provided with an accessory outlet located inside the chamber, on the back wall. The power switch on the main control panel controls power to this outlet.

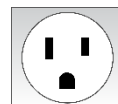

- The outlet is intended to power low-draw equipment such as magnetic stirrers or a volatile compounds scrubber fan.
- **Do not attach equipment drawing more than 1 amp from the outlet.**

### **Waste Heat**

Accessory equipment may generate heat in the incubation chamber. This can affect the temperature performance of the incubator.

## *HUMIDIFYING THE INCUBATOR*

Long-term use of a large water container, such as a humidifier pan, will create excess water vapor in the unit and can damage the electrical components of an SMI series dry incubator. Additionally, use of **deionized water** may cause significant corrosion damage to the incubator. Overloading the unit with sample media may also damage the incubator from excessive media evaporation and disruption of air flow pathways through the shelf space.

### **Small Sample Load**

Placing a small number of petri dishes or other media containers in the incubator chamber may lead to excessively fast drying of sample media. A **small** water-filled container, such as an open flask, may be placed in the chamber to help slow sample drying with small loads.

## *CONDENSATION AND THE DEW POINT*

Condensation takes place whenever the humidity level in the incubator chamber reaches the dew point. The dew point is the level of humidity at which the air cannot hold more water vapor. The warmer the air, the more water vapor it can hold.

As the level of humidity rises in an incubation chamber, condensate will first appear on surfaces that are cooler than the air temperature. Near the dew point, condensate forms on any item or exposed surface even slightly cooler than the air. When the dew point is reached, condensate forms on nearly all exposed surfaces.

Ambient relative humidity exceeding 80% or overloading the incubation chamber with open or breathable sample containers will likely result in condensation in the chamber, possible leaks around the incubator. This may cause corrosion damage if allowed to continue for any significant length of time.

Managing condensation primarily depends on either lowering the humidity level or increasing the air temperature in the incubator chamber.

---

**Note:** Rising or falling air pressure from the weather will adjust the dew point up and down in small increments. If the relative humidity in the incubation chamber is already near the dew point, barometric fluctuations may push it across the dew threshold.

**Note:** Thin air at higher altitudes holds less humidity than the denser air found at or near sea level.

---

If excessive condensate has appeared in the incubation chamber, dry the chamber interior and check the following.

- Check the door gaskets for damage, wear, or signs of brittleness or dryness. Arrange for replacement of the gaskets if damaged or excessively worn.
- Verify the chamber access port is closed. The black, plastic shipping cap that came with the unit should be installed on the outside of the incubator and not in the chamber.
- Make sure samples on the shelves are evenly spaced to allow for good airflow.
- Ensure the chamber door is closing and latching properly.
- Are frequent or lengthy chamber door openings causing significant temperature disruptions and chilling the chamber surfaces? If so, reduce the number of openings.
- Are there too many open or “breathable” containers of evaporating sample media in the chamber? If so, reduce the number of open sample containers.
- Does the ambient humidity in the room exceed the stated operating range of 80% relative environmental humidity? If so, lower the room humidity.
- Is the incubator exposed to an external flow of cold air such as an air-conditioning vent or a door to a cooler hallway or adjacent room? Block or divert the air, or reposition the unit.



# USER MAINTENANCE

---

**Warning:** Disconnect this unit from its power supply prior to performing maintenance or services.

**Avertissement:** Débranchez cet appareil de son alimentation électrique avant d'effectuer la maintenance ou les services.

---



## *CLEANING AND DISINFECTING*

If a hazardous material or substance has spilled in the unit chamber, immediately initiate your site Hazardous Material Spill Containment protocol. Contact your local Site Safety Officer and follow instructions per the site policy and procedures.

- Periodic cleaning and disinfection are required.
- Do not use spray on cleaners or disinfectants. These can leak through openings and coat electrical components.
- Consult with the manufacturer or their agent if you have any doubts about the compatibility of decontamination or cleaning agents with the parts of the equipment or with the material contained in it.
- Do not use cleaners or disinfectants that contain solvents capable of harming paint coatings or stainless steel surfaces. **Do not use chlorine-based bleaches or abrasives; these will damage the chamber liner.**

---

**Warning:** Exercise caution if cleaning the unit with alcohol or flammable cleaners. Always allow the unit to cool down to room temperature prior to cleaning and make sure all cleaning agents have evaporated or otherwise been completely removed prior to putting the unit back into service.

**Avertissement:** Soyez prudent lorsque vous nettoyez l'appareil avec de l'alcool ou des produits de nettoyage inflammables. Laissez toujours refroidir l'appareil à la température ambiante avant le nettoyage et assurez-vous que tous les produits de nettoyage se sont évaporés ou ont été complètement enlevés avant de remettre l'appareil en service.

---



### **Cleaning**

1. Disconnect the unit from its power supply.
2. Remove all removable interior components such as shelving and accessories.
3. Clean the unit with a mild soap and water solution, including all corners.
  - **Do not use an abrasive cleaner**, these will damage metal surfaces.
  - **Do not use deionized water to rinse or clean with!**
  - Take special care when cleaning around the temperature sensor probes in the chamber to prevent damage. Do not clean the probes.
4. Rinse with distilled water and wipe dry with a soft cloth.

## Disinfecting

For maximum effectiveness, disinfection procedures are typically performed after cleaning. Keep the following points in mind when disinfecting the unit.

- Turn off and disconnect the unit to safeguard against electrical hazards.
- Disinfect the unit chamber using commercially available disinfectants that are non-corrosive, non-abrasive, and suitable for use on stainless steel and glass surfaces. Contact your local Site Safety Officer for detailed information on which disinfectants are compatible with your applications.
- If permitted by your protocol, remove all removable interior accessories (shelving and other non-attached items) from the chamber when disinfecting.
- Disinfect all surfaces in the chamber, making sure to thoroughly disinfect the corners. Exercise care to avoid damaging the sensor probes.

When disinfecting external surfaces, use disinfectants that will not damage painted metal, glass, and plastic

## *MINIMIZING CONTAMINATION EXPOSURE*

The following are suggestions for minimizing exposure of the incubator chamber to potential contaminants.

- Maintain a high air quality in the laboratory workspaces around the incubator.
- Avoid placing the incubator near sources of air movement such as doors, air vents, or high traffic routes in the workspace.
- Minimize the number of times the incubator chamber door is opened during normal operations.

## *STORING THE INCUBATOR*

Perform the following steps if the incubator will be out of use for more than 24 hours to prevent microbiological contamination such as fungus or mold.

1. Depower the incubator.
2. Disinfect and clean if required by your laboratory protocol, or if the chamber has been exposed to pathogenic microorganisms.
3. Use a soft cloth to dry the chamber surfaces.

## *DOOR COMPONENTS*

Periodically, inspect the door latch, trim, catch, and gaskets for signs of deterioration. Failure to maintain the integrity of the door system shortens the life span of the incubator.

## *ELECTRICAL COMPONENTS*

Electrical components do not require maintenance. If the incubator fails to operate as specified, please contact your distributor or [Technical Support](#) for assistance.

# USER MAINTENANCE

## CALIBRATE THE TEMPERATURE DISPLAY



**Note:** Performing a temperature display calibration requires a temperature reference device. Please see the [Reference Sensor Device entry](#) on page 6 for the device requirements.

**Note:** Each SMI12 incubation chamber must be independently calibrated to its temperature display.

Temperature calibrations are performed to match an incubator temperature display to the actual air temperature inside the incubation chamber. The actual air temperature is supplied by a calibrated reference device. Calibrations compensate for long-term drifts in the incubator microprocessor controller as well as those caused by the natural material evolution of the sensor probe in the heated incubator space. Calibrate as often as required by your laboratory or production protocol, or regulatory compliance schedule. Always calibrate to the standards and use the calibration setup required by your industry requirements or laboratory protocol.

### A suggested calibration setup

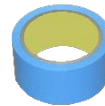

**Heat-resistant  
non-stick tape  
recommended**

1. Introduce the reference device thermocouple sensor probes into the incubation chamber through the access port on the right side of the incubator.
2. Position the sensor probes in the incubation chamber with the probe heads at least at least 2 inches (51mm) in diagonally from the chamber corners. The probe heads should be at least 2 inches (51mm) above the shelving to avoid heat sinking. Place 1 probe head as close as possible to the geometric center point of the chamber.

Secure all probes in place with non-stick, heat-resistant tape.

If using a only single thermocouple, place the sensor probe head as close as possible to the geometric center of the incubation chamber.

3. After securing the probe heads in position, carefully place the access port stopper in the port over the probe wires. Use non-stick tape to seal any gaps created between the stopper and the port by the probe wires.

4. The incubation chamber door must be closed and latched. Failure to do so will prevent an accurate calibration.

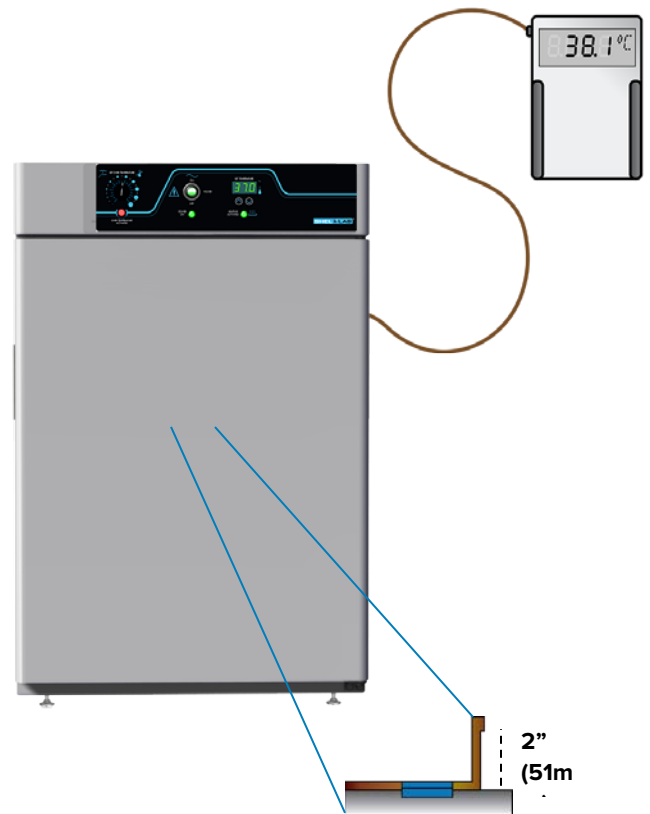

# USER MAINTENANCE

## 5) Temperature Stabilization

The incubator air temperature must stabilize in order to perform an accurate calibration.

- Allow the incubator to operate undisturbed with the doors shut for **at least 8 hours** when first putting the unit into operation in a new environment.
- To be considered stabilized, the incubator chamber must operate at your calibration temperature for **at least 1 hour with no fluctuations of  $\pm 0.1^{\circ}\text{C}$  or greater.**

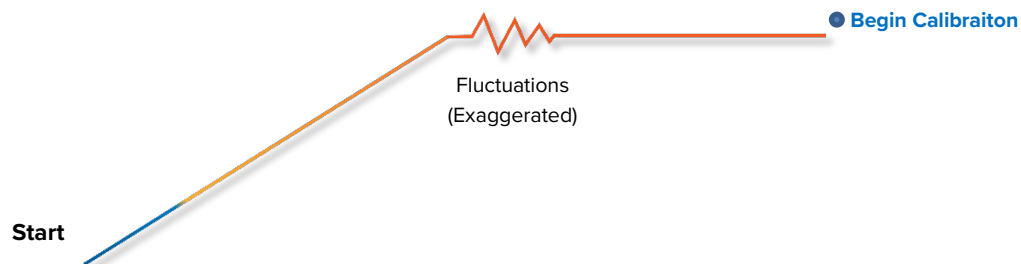

Required temperature stabilization period operating undisturbed with the incubator door(s) closed.

### Suggested Temperature Calibration

1

Once the incubator temperature has stabilized, compare the reference device and incubator temperature display readings.

- If the readings are the same, or the difference between the two falls within the acceptable range of your protocol, the display is accurately showing the incubator air temperature. **The Temperature Calibration procedure is now complete.**

- Or -

- If a difference falls outside of your protocol range, advance to step 2.

Reference Device

37.0 °C

SET TEMPERATURE

37.0 ✓

2

A display calibration adjustment must be entered to match the display to the reference device. See next step.

Reference Device

38.1 °C

37.0 ✗

Continued next page

# USER MAINTENANCE

## Temperature Calibration Continued

3

Place the display in its temperature calibration mode.

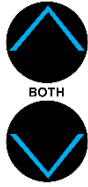

- Press and hold both the **UP and DOWN** temperature arrow buttons simultaneously for approximately 5 seconds.
- Release the buttons when the temperature display shows the letters "C O". The display will begin flashing the **current temperature display value**.



**Note:** If an arrow key is not pressed for five seconds, the display will cease flashing, and store the last displayed number as the new current chamber temperature value.

4

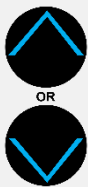

Use the **Up** or **Down** arrows to adjust the current display temperature value until it matches the reference device temperature reading.

### Reference Device

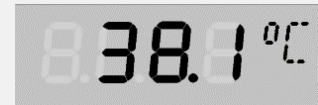

5

After matching the display to the reference device, wait 5 seconds.



Wait 5 Seconds

- The temperature display will cease flashing and store the corrected chamber display value.
- The incubator will now begin heating or passively cooling in order to reach the set point with the corrected display value.



Cooling to Set Point

6



Wait 1 Hour

**After** the incubator has achieved the corrected temperature, allow the chamber to sit at least one 1 hour undisturbed to stabilize.

- Failure to wait until the incubator is fully stabilized will result in an inaccurate reading.



Set Point Achieved

Continued next page

# USER MAINTENANCE

7

Compare the reference device reading with the chamber temperature display again.

- If the reference device and the chamber temperature display readings are the same or the difference falls within the range of your protocol, **the incubator is now calibrated for temperature.**

- OR -

- See the next step if the readings fail to match or fall outside of your protocol range.

Reference Device



8

If the two readings are not the same, and the difference still falls outside the acceptable range of your protocol, repeat steps 3 – 7 up to two more times.

Three calibration attempts may be required to successfully calibrate units that are more than  $\pm 2^{\circ}\text{C}$  out of calibration.

Reference Device



9

If the temperature readings of the incubator temperature display and the reference device still fall outside your protocol after three calibration attempts, contact your incubator distributor or [Technical Support](#) for assistance.

End of procedure

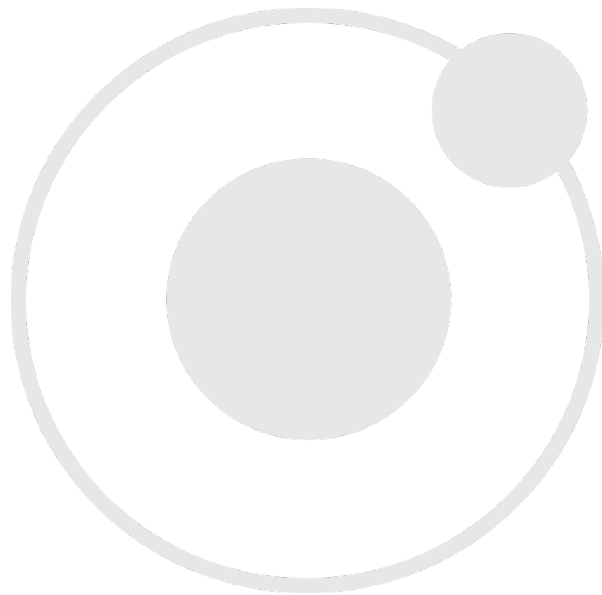



# UNIT SPECIFICATIONS

These incubators are 100–120 volt. Please refer to the incubator data plate for individual electrical specifications.

Technical data specified applies to units with standard equipment at an ambient temperature of 25°C and at nominal voltage. The temperatures specified are determined in accordance with factory standard following DIN 12880 respecting the recommended wall clearances of 10 % of the height, width, and depth of the inner chamber. All indications are average values, typical for units produced in the series. We reserve the right to alter technical specifications at all times.

## WEIGHT

Model	Shipping	Net Incubator Weight
SMI2	117 lbs. / 53 kg	83.0 lbs. / 37.6 kg
SMI6	183 lbs. / 83 kg	158.0 lbs. / 71.7 kg
SMI7	198 lbs. / 90 kg	162.0 lbs. / 73.5 kg
SMI11	300 lbs. / 136 kg	195.0 lbs. / 88.5 kg
SMI12	550 lbs. / 250 kg	316.0 lbs. / 143.3 kg

## DIMENSIONS

In inches

Model	Exterior W × D × H	Interior W × D × H
SMI2	21.3 × 22.3 × 26.0 in	15.0 × 15.0 × 15.2 in
SMI6	25.3 × 27.3 × 38.0 in	19.5 × 20.0 × 26.0 in
SMI7	30.0 × 31.0 × 32.0 in	23.7 × 24.0 × 20.0 in
SMI11	42.0 × 27.0 × 38.0 in	36.2 × 20.0 × 26.0 in
SMI12*	25.3 × 27.3 × 76.0 in	19.5 × 20.0 × 26.0 in

\* Each chamber

In millimeters

Model	Exterior W × D × H	Interior W × D × H
SMI2	541 × 566 × 660 mm	381 × 381 × 386 mm
SMI6	643 × 693 × 965 mm	495 × 508 × 660 mm
SMI7	762 × 787 × 813 mm	602 × 610 × 508 mm
SMI11	1067 × 686 × 965 mm	920 × 508 × 660 mm
SMI12*	643 × 693 × 1930 mm	495 × 508 × 660 mm

\* Each chamber

# UNIT SPECIFICATIONS

## CAPACITY

Model	Feet	Liters
SMI2	2.0	56.3
SMI6	5.9	166.0
SMI7	6.5	184.0
SMI11	10.9	309.0
SMI12*	11.7*	332.0*
*Each chamber		









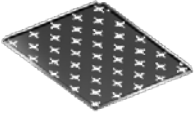

## TEMPERATURE

Model	Range	Uniformity	Stability
All	Ambient +8° to 70°C	±0.5° @ 37°C	±0.1°C @ 37°C

## POWER

Model	AC Voltage	Amperage
SMI2	100–120	4.5
SMI6	100–120	6.0
SMI7	100–120	6.5
SMI11	100–120	7.0
SMI12	100–120	12.0 (6.0 each chamber)

# PARTS LIST

Description	Parts Number		
Fuse, 6.3 Amp 250V, SMI2, SMI6, SMI12	 <b>3300515</b>	Shelf, SMI6, SMI12	 <b>5130523</b>
Fuse, 10 Amp 250V SMI7, SMI1	 <b>3300516</b>	Shelf Slide, SMI6, SMI12	 <b>5081201</b>
Leveling Foot	 <b>2700512</b>	Shelf, SMI7	 <b>5130518</b>
Power Cord 115 volt 15 Amp, 9ft 5 in (2.86m) NEMA 5-15P	 <b>1800510</b>	Shelf Slide, SMI7	 <b>5081205</b>
Shelf, SMI2	 <b>5080758</b>	Shelf, SMI11	 <b>5130687</b>
Shelf Slide, SMI2	 <b>5081174</b>	Shelf Slide, SMI11	 <b>5081201</b>

## ORDERING PARTS AND CONSUMABLES

If you have the Part Number for an item, you may order it directly from Sheldon Manufacturing by calling 1-800-322-4897 extension 3. If you are uncertain that you have the correct Part Number, or if you need that specific item, please contact Sheldon Technical Support for help at 1-800-322-4897 extension 4 or (503) 640-3000. Please have the **model** and **serial number** of the unit ready, as Tech Support will need this information to match your chamber with its correct part.



**SHELDON**  
MANUFACTURING, INC

P.O. Box 627  
Cornelius, OR 97113  
USA

[support@sheldonmfg.com](mailto:support@sheldonmfg.com)  
[sheldonmanufacturing.com](http://sheldonmanufacturing.com)

1-800-322-4897  
(503) 640-3000  
FAX: 503 640-1366