

CUTSHEET

Front View

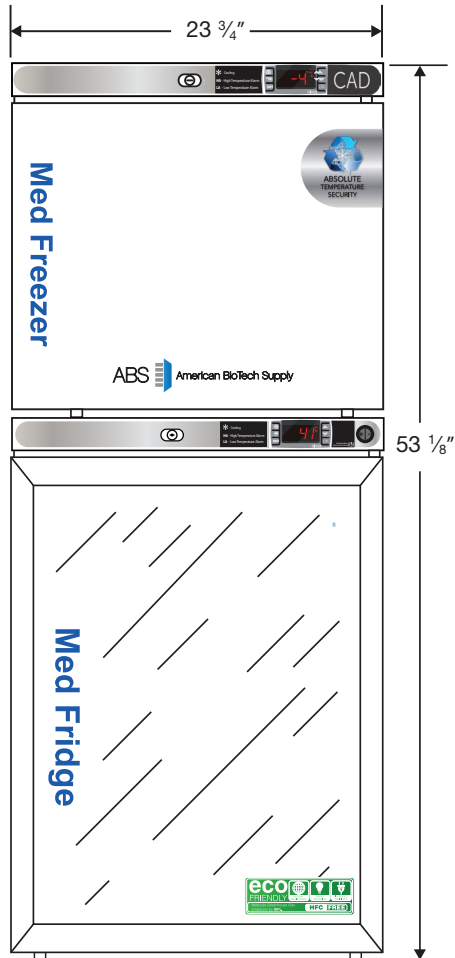

Side View

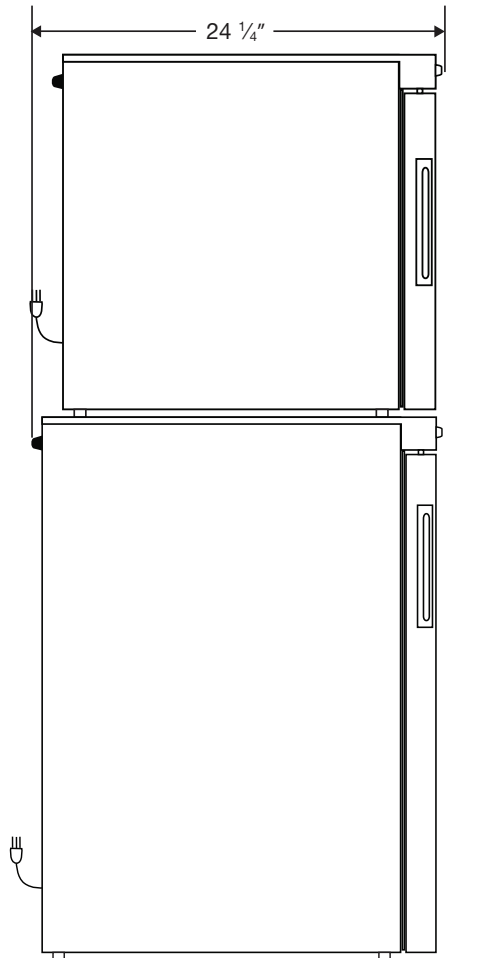

Top View

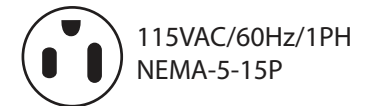
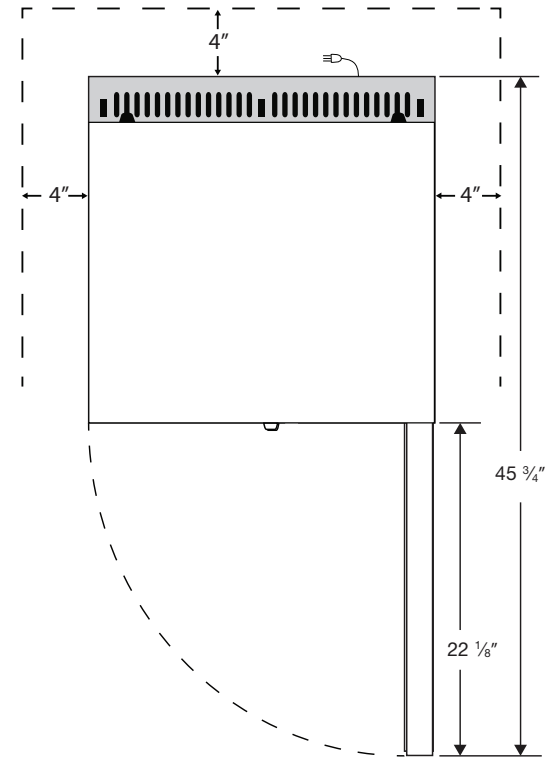

NOTE: Ventilation Requirements – Minimum 4" clearance on sides and back

Compartment	Cu. Ft	Defrost	Door	Int Door	Shelves	W"	D"	H"	Refrigerant	H.P.	Amps	Weight
Freezer	1	Controlled Auto	1 Solid	0	2 Adj.	23 3/4	24 1/4	53 1/8	R600a	1/8	1	135 lbs.
Refrigerator	5.2	Cycle	1 Glass	0	3 Adj.					1/6	1.3	