

Operating Manual

Cryo-Compact Circulators

The *HighTech* Series

CF31

CF41

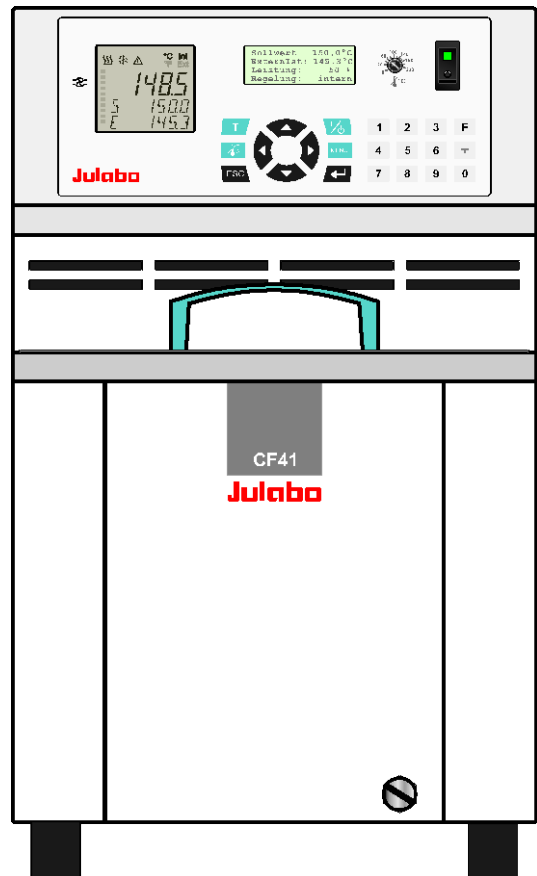

Julabo
THE TEMPERATURE CONTROL COMPANY

JULABO USA, Inc.
884 Marcon Boulevard
Allentown, PA 18109
Phone: +1(610) 231-0250
Fax: +1(610) 231-0260
info@julabo.us
www.julabo.us

Congratulations!

You have made an excellent choice.

JULABO thanks you for the trust you have placed in us.

This operating manual has been designed to help you gain an understanding of the operation and possible applications of our Cryo-Compact Circulators. For optimal utilization of all functions, we recommend that you thoroughly study this manual prior to beginning operation.

Unpacking and inspecting

Unpack the Cryo-Compact Circulator and accessories and inspect them for possible transport damage. Damage should be reported to the responsible carrier, railway, or postal authority, and a damage report should be requested. These instructions must be followed fully for us to guarantee our full support of your claim for protecting against loss from concealed damage. The form required for filing such a claim will be provided by the carrier.

Important: keep original operating manual for future use

TABLE OF CONTENTS

1. Intended use	5
1.1. Description	5
2. Operator responsibility – Safety instructions.....	6
2.1. Disposal.....	7
3. Technical specifications.....	8
4. Safety notes for the user	12
4.1. Explanation of safety notes.....	12
4.2. Explanation of other notes	12
4.3. Safety instructions.....	12
5. Operating controls and functional elements.....	15
6. Preparations.....	19
6.1. Installation	19
6.2. Temperature application to external systems.....	20
6.3. Tubing	22
6.4. Bath fluids.....	23
7. Operating procedures.....	24
7.1. Power connection.....	24
7.2. Filling	24
7.3. Switching on / Selecting the language.....	25
8. Manual operation	26
8.1. Start - Stop	26
8.2. Control of the cooling machine	26
8.3. Setting the temperatures.....	27
8.4. Safety installations, warning functions.....	28
8.4.1. Excess temperature protection	28
8.4.2. Early warning system, low level protection	31
9. Menu functions	32
9.1. Configuration.....	33
9.2. Control.....	37
9.3. Start of a profile.....	41
9.3.1. Edit after start	43
9.3.2. Interrupting a profile	45

9.3.3.	Interruption after a power failure.....	45
9.3.4.	Termination of a profile	46
9.4.	Integrated programmer.....	47
9.5.	Analog inputs/outputs	50
9.5.1.	REG+E-PROG – temperature recorder outputs.....	52
9.5.2.	REG+E-PROG - programmer input.....	53
9.5.3.	STAND-BY input.....	55
9.5.4.	ALARM output.....	56
9.6.	Limits.....	57
9.7.	Serial interface.....	59
9.8.	ATC Absolute Temperature Calibration, 3-point calibration	60
9.9.	Setting the pump pressure	63
10.	Troubleshooting guide / Error messages.....	64
11.	Electrical connections	67
12.	Remote control.....	69
12.1.	Setup for remote control.....	69
12.2.	Communication with a PC or a superordinated data system	69
12.3.	List of commands.....	70
12.4.	Status messages	73
12.5.	Error messages	74
13.	JULABO Service – Online remote diagnosis.....	75
14.	Installation of electronic module.....	76
14.1.	Draining.....	76
15.	Cleaning / repairing the unit	77
16.	WARRANTY PROVISIONS	78

1. Intended use

JULABO Cryo-Compact Circulators have been designed for temperature application to specific fluids in a bath tank. The units feature pump connections for temperature control of external systems (loop circuit).



JULABO circulators are not suitable for direct temperature control of foods, semi-luxury foods and tobacco, or pharmaceutical and medical products. Direct temperature control means unprotected contact of the object with the bath medium (bath fluid).

1.1. Description

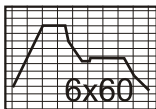
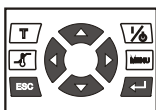
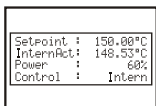
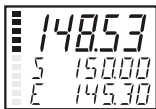

ICC

TCF

ATC³

RS232
RS485

Pt100

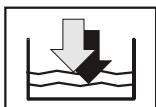
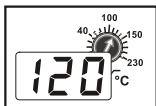

SMART PUMP

- ☑ The Cryo-Compact circulators are operated via the splash-proof keypad. The implemented microprocessor technology allows to set and to store different values that can be indicated on the VFD COMFORT-DISPLAY and LCD DIALOG-DISPLAY. Three menu keys facilitate adjusting setpoints, warning and safety functions and menu functions.
- ☑ The integrated programmer allows storing and running temperature and time-dependent processes.
- ☑ The control electronics including "ICC - Intelligent Cascade Control" automatically adapts the heat supplied to the thermal requirements of the bath.
- ☑ The TCF - **T**emperature **C**ontrol **F**eatures allow the user to have access to all important temperature control parameters. This means: Full control on the control mode and the chance to manually adjust or adapt control to the specific application.
- ☑ Absolute Temperature Calibration (ATC3). With the 3-point calibration an offset is adjusted at three temperatures to ensure an accurate temperature pattern at the selected spot in the bath over the full temperature range.
- ☑ Electrical connections:
The serial interface, switchable from RS232 to RS485, allows modern process technology without additional interface.
Connection for Pt100 external sensor for external temperature measurement and control.
Alarm output for external alarm message or control of JULABO refrigerating baths or solenoid valve (cooling water).
The electronic module (option) provides 3 further analog connections (alarm input, standby input, recorder output, programmer input).
- ☑ The excess temperature protection conforming to IEC 61010-2-010 is a safety installation independent from the control circuit. This protection can be indicated and set on the LCD DIALOG-DISPLAY.
- ☑ The early warning system for low level signals that bath fluid needs to be refilled before the low level protection conforming to IEC 61010-2-010 causes a complete shut-down of the main functional elements.
- ☑ Intelligent pump system: The pump capacity (electronically adjustable via the motor speed) enables to adapt to varying conditions for internal and external temperature applications..

2. Operator responsibility – Safety instructions

The products of JULABO ensure safe operation when installed, operated, and maintained according to common safety regulations. This section explains the potential dangers that may arise when operating the circulator and also specifies the most important safety precautions to preclude these dangers as far as possible.

The operator is responsible for the qualification of the personnel operating the units.

- The personnel operating the units should be regularly instructed about the dangers involved with their job activities as well as measures to avert these dangers.
- Make sure all persons tasked with operating, installing, and maintaining the unit have read and understand the safety information and operating instructions.
- When using hazardous materials or materials that could become hazardous, the circulator may be operated only by persons who are absolutely familiar with these materials and the circulator. These persons must be fully aware of possible risks.

If you have any questions concerning the operation of your unit or the information in this manual, please contact us!

Contact	JULABO USA, Inc. 884 Marcon Boulevard Allentown, PA 18109	Phone: +1(610) 231-0250 Fax: +1(610) 231-0260 info@julabo.us www.julabo.us
----------------	---	---

Safety instructions for the operator:

- Avoid strikes to the housing, vibrations, damage to the operating-element panel (keypad, display), and contamination.
- Make sure the product is checked for proper condition regularly (depending on the conditions of use). Regularly check (at least every 2 years) the proper condition of the mandatory, warning, prohibition and safety labels.
- Make sure that the mains power supply has low impedance to avoid any negative effects on the instruments being operated on the same mains.
- This unit is designed for operation in a controlled electromagnetic environment. This means that transmitting devices (e.g., cellular phones) should not be used in the immediate vicinity.
- Magnetic radiation may affect other devices with components sensitive to magnetic fields (e.g., monitors). We recommend maintaining a minimum distance of 1 m.
- Permissible ambient temperature: max. 40 °C, min. 5 °C.
- Permissible relative humidity: 50% (40 °C).
- Do not store the unit in an aggressive atmosphere. Protect the unit from contamination.
- Do not expose the unit to sunlight.

Appropriate operation

Only qualified personnel is authorized to configure, install, maintain, or repair the circulator. Persons who operate the circulator must be trained in the particular tasks by qualified personnel. The summarized user guidance (short manual) and the specification table with information on individual parameters are sufficient for this.

Use

The bath can be filled with flammable materials. Fire hazard!



There might be chemical dangers depending on the bath medium used.

Observe all warnings for the used materials (bath fluids) and the respective instructions (safety data sheets).

Insufficient ventilation may result in the formation of explosive mixtures. Only use the unit in well ventilated areas.



Only use recommended materials (bath fluids). Only use non-acid and non corroding materials.

When using hazardous materials or materials that could become hazardous, the operator must affix the enclosed safety labels (1 + 2) to the front of the unit so they are highly visible:

1		Danger area. Attention! Observe instructions. (operating manual, safety data sheet)
2a		Carefully read the user information prior to beginning operation. Scope: EU
or		
2b		Carefully read the user information prior to beginning operation. Scope: USA, NAFTA

Particular care and attention is necessary because of the wide operating range.

There are thermal dangers: Burn, scald, hot steam, hot parts and surfaces that can be touched.

	Hot surface warning. (The label is put on by JULABO)
	Low temperature warning. (The label is put on by JULABO)

Observe the instructions in the manuals for instruments of a different make that you connect to the circulator, particularly the corresponding safety instructions. Also observe the pin assignment of plugs and technical specifications of the products.

2.1. Disposal

The product may be used with oil as bath fluid. These oils fully or partially consist of mineral oil or synthetic oil. For disposal, follow the instructions in the material safety data sheets.

This unit contains refrigerants, which at this time are not considered harmful to the ozone layer. However, over the long operating period of the unit, disposal rules may change. Therefore, only qualified personnel should handle the disposal.

3. Technical specifications

Performance specifications measured in accordance with DIN12876. Cooling capacities up to 20°C measured with ethanol; over 20°C with thermal oil unless specified otherwise.

Performance specifications apply at an ambient temperature of 20°C. Performance values may differ with other bath fluids.

CF31			
Working temperature range	°C		-30 ... +200
Temperature stability	°C		±0.02
Temperature selection			digital
via keypad			indication on LCD DIALOG-DISPLAY (°C/°F)
remote control via personal computer			indication on monitor
Temperature indication:			VFD COMFORT-DISPLAY
Resolution	°C		0.01
Pump pressure stage			indication on VFD COMFORT-DISPLAY
Temperature control			ICC - Intelligent Cascade Control
Working temperature sensor			Pt 100
Safety temperature sensor			Pt 100
Absolute Temperature Calibration			
at internal control	°C		±3
at external control	°C		±10
Heater wattage	(at 230 V)	kW	2,0
Heater wattage	(at 115 V)	kW	1,0
Cooling capacity	°C		<u>20</u> 0 -20
	kW		0.32 0.25 0.15
Cooling compressor			1-stage
Refrigerant			R134a
Cooling machine			Air-cooled
Electronically adj. pump capacity			1 ... 4 stages
Flow rate	min ... max. at 0 bar	l/min	22 ... 26
Pressure max.	at 0 liter	bar	0,7
Suction max	at 0 liter	bar	0,4
Bath opening (WxL)		cm	16x3
Bath depth		cm	14
Filling volume		liters	2.0 ... 3.0
Overall dimensions (WxDxH)		cm	24x46x40
Weight		kg	35
Ambient temperature		°C	5 ... 40
Mains power connection	230 V/50 Hz	V/ Hz	207-253 / 50
Current input (at 230 V)		A	11
Mains power connection	230 V/60 Hz	V/ Hz	207-253 / 60
Current input (at 230 V)		A	12
Mains power connection	115 V/60 Hz	V/ Hz	103-127 / 60
Current input (at 115 V)		A	14

All measurements have been carried out at: rated voltage and frequency ambient temperature: 20 °C.

CF41			
Working temperature range	°C		-40 ... +200
Temperature stability	°C		±0.02
Temperature selection			digital
via keypad			indication on LCD DIALOG-DISPLAY (°C/°F)
remote control via personal computer			indication on monitor
Temperature indication:			VFD COMFORT-DISPLAY
Resolution	°C		0.01
Pump pressure stage			indication on VFD COMFORT-DISPLAY
Temperature control			ICC - Intelligent Cascade Control
Working temperature sensor			Pt 100
Safety temperature sensor			Pt 100
Absolute Temperature Calibration			
at internal control	°C		±3
at external control	°C		±10
Heater wattage	(at 230 V)	kW	2,0
Heater wattage	(at 115 V)	kW	1,0
Cooling capacity	°C		<u>20</u> 0 -20 -30
		kW	0.47 0.4 0.28 0.12
Cooling compressor			1-stage
Refrigerant			R452A*, R449A**
Cooling machine			Air-cooled
Electronically adj. pump capacity			1 ... 4
Flow rate	min ... max. at 0 bar	l/min	22 ... 26
Pressure max.	at 0 liter	bar	0,7
Suction max	at 0 liter	bar	0,4
Bath opening (WxL)		cm	19x3
Bath depth		cm	19
Filling volume		Liter	4.0 ... 5.5
Overall dimensions (WxDxH)		cm	28x46x46
Weight		kg	42
Mains power connection	230 V/50 Hz	V/Hz	207-253 / 50
Current input (at 230 V)		A	13
Mains power connection	230 V/60 Hz	V/Hz	207-253 / 60
Current input (at 230 V)		A	13
Mains power connection	115 V/60 Hz	V/Hz	103-127 / 60
Current input (at 115 V)		A	16

* at 230 V/50 Hz,

** at 230 V/60 Hz, 115 V/60 Hz

All measurements have been carried out at: rated voltage and frequency ambient temperature: 20 °C.

Electrical connections:

Computer interface	RS232 / RS485
External sensor	Pt100

Optional: (Order No. 8900100 Electronic module with analog connections)	
Programmer input -100 °C to 400 °C = 0 - 10 V or 0 - 20 mA or 4 - 20 mA	
Input for the signal of a flow meter or external manipulated variable	
Temperature recorder outputs	0 - 10 V (0 V = -100 °C, 10 V = 400 °C) 0 - 20 mA (0 mA = -100 °C, 20 mA = 400 °C) 4 - 20 mA (4 mA = -100 °C, 20 mA = 400 °C)
Standby input	for external emergency switch-off
Alarm output	for external alarm signal

Warning functions and safety installations

Excess temperature protection	adjustable from 0 °C ... 220 °C
Low liquid level protection	float switch
Early warning system for low level	float switch
Classification according to DIN 12876-1	class III
Alarm message	optical + audible (permanent)
Warning message	optical + audible (in intervals)
Overload protection	for compressor and pump motor
High temperature warning function	optical + audible (in intervals)
Low temperature warning function	optical + audible (in intervals)
Supervision of working sensor	plausibility control
Reciprocal sensor monitoring between working and safety sensors	difference >35 K

Environmental conditions according to IEC 61 010-1:

- Use indoors only.
- Altitude up to 2000 m - normal zero.
- Ambient temperature: see Technical specifications
- Humidity:
 - Max. relative humidity 80% for temperatures up to +31 °C,
 - linear decrease down to 50% relative humidity at a temperature of +40 °C.

Protection class according to IEC 60 529	IP21
The unit corresponds to Class	I
Overvoltage category	II
Pollution degree	2



Caution:

The unit is not for use in explosive environment.

EMC requirements according to EN 61326-1

The device is an ISM device of group 1 per CISPR 11 (uses HF for internal purposes) and is classified in class A (industrial and commercial sector).



Note!

- Devices of class A are intended for the use in an industrial electromagnetic environment.
- When operating in other electromagnetic environments, their electromagnetic compatibility may be impacted.
- This device is not intended for the use in living areas and cannot guarantee adequate protection of the radio reception in such environments.

Information about the used refrigerants

The **Regulation (EU) No. 517/2014 on fluorinated greenhouse gases** applies to all systems which contain fluorinated refrigerants and replaces (EC) 842/2006.

The aim of the Regulation is to protect the environment by reducing emissions of fluorinated greenhouse gases.

Among other things it regulates the emission limits, use and recovery of these substances. It also contains requirements for operators of systems which require / contain these substances to function.

Under Regulation 517/2014, the operator of a system of this nature has the following duties:

- The operator must ensure that the equipment is checked at regular intervals for leaks.
- These intervals depend on the CO₂ equivalent of the system. This is calculated from the refrigerant fill volume and type of refrigerant. The CO₂ equivalent of your system is shown on the model plate.
- The operator undertakes to have maintenance, repair, service, recovery and recycling work carried out by certified personnel who have been authorized by JULABO.
- All such work must be documented. The operator must keep records and archive them for at least five years. The records must be submitted to the relevant authority on request.

Refer to the text of the Regulation for further information.

4. Safety notes for the user

4.1. Explanation of safety notes



In addition to the safety warnings listed above, warnings are posted throughout the manual. These warnings are designated by an exclamation mark inside an equilateral triangle. "Warning of a dangerous situation (Attention! Please follow the documentation)."

The danger is classified using a signal word.
Read and follow these important instructions.



Warning:

Describes a possibly highly dangerous situation. If these instructions are not followed, serious injury and danger to life could result.



Caution:

Describes a possibly dangerous situation. If this is not avoided, slight or minor injuries could result. A warning of possible property damage may also be contained in the text.



Notice:

Describes a possibly harmful situation. If this is not avoided, the product or anything in its surroundings can be damaged.

4.2. Explanation of other notes



Note!

Draws attention to something special.



Important!

Indicates usage tips and other useful information.

4.3. Safety instructions

Follow the safety instructions to avoid personal injury and property damage. Also, the valid safety instructions for workplaces must be followed.



- Only connect the unit to a power socket with an earthing contact (PE – protective earth)!
- The power supply plug serves as a safe disconnecting device from the line and must always be easily accessible.
- Place the unit on an even surface on a base made of nonflammable material.
- Do not stay in the area below the unit.
- Make sure you read and understand all instructions and safety precautions listed in this manual before installing or operating your unit.
- Set the excess temperature safety installation below the flash point of the bath fluid.
- Never operate the unit without bath fluid in the bath.
- Pay attention to the thermal expansion of bath oil during heating to avoid overflowing of the fluid.
- Prevent water from entering the hot bath oil.
- Do not drain the bath fluid while it is hot!
Check the temperature of the bath fluid prior to draining (e.g., by switching the

unit on for a short moment).

- Use suitable connecting tubing.
- Avoid sharp bends in the tubing, and maintain a sufficient distance from surrounding walls.
- Make sure that the tubing is securely attached.
- Regularly check the tubing for material defects (e.g., for cracks).
- Never operate damaged or leaking units.
- Always turn off the unit and disconnect the mains cable from the power source before performing any service or maintenance procedures, or before moving the unit.
- Always turn off the unit and disconnect the mains cable from the power source before cleaning the unit.
- Always empty the bath before moving the unit.
- Transport the unit with care.
- Sudden jolts or drops may cause damage in the interior of the unit.
- Observe all warning labels.
- Never remove warning labels.
- Never operate units with damaged mains power cables.
- Repairs are to be carried out only by qualified service personnel.



- Some parts of the bath tank and the pump connections may become extremely hot during continuous operation. Therefore, exercise particular caution when touching these parts.



- Some parts of the bath tank and the pump connections may become extremely cold during continuous operation. Therefore, exercise particular caution when touching these parts.



Caution:

The circulator may be used, for example, to control the temperature of fluids in a reactor.

We do not know what substances are contained in these vessels.

Many substances are:

- inflammable, easily ignited, or explosive
- hazardous to health
- environmentally hazardous

i.e.: **dangerous**

The user alone is responsible for the handling of these substances!

The following questions should help to recognize possible dangers and to reduce the risks to a minimum.

- Are all tubes and electrical cables connected and layed?
Note:
sharp edges, hot surfaces in operation, moving machine parts, etc.
- Do dangerous vapors or gases develop during heating?
Must the work be done in a fume hood?
- What to do when a dangerous substance was spilled on or in the unit?
Before starting to work, obtain information concerning the substance and determine the method of decontamination.



Notice:

Check the safety installations at least twice a year!

- Excess temperature protection according to IEC 61010-2-010
With a screwdriver, turn back the adjustable excess temperature protection until the shutdown point (actual temperature).
- Low level protection according to IEC 61010-2-010
To check the function of the float, it can be manually lowered with a screwdriver, for example.



WARNING

This product contains chemicals known to the state of California to cause cancer, birth defects or other reproductive harm.

5. Operating controls and functional elements

Front view CF41 / CF31

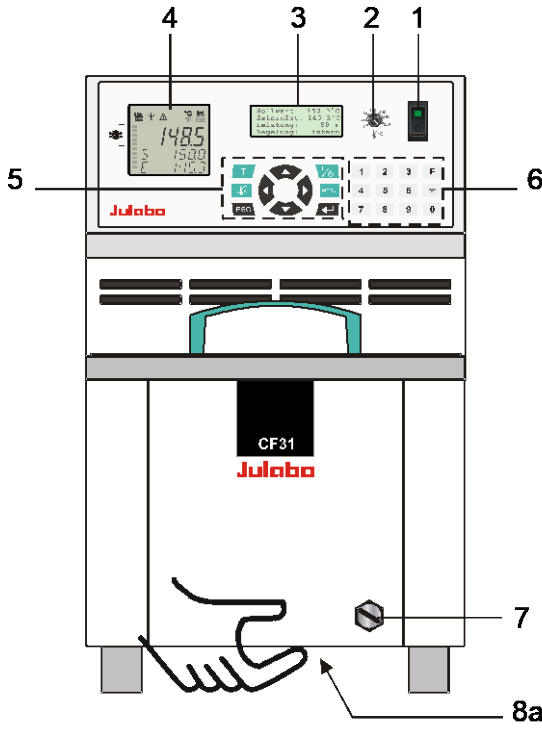
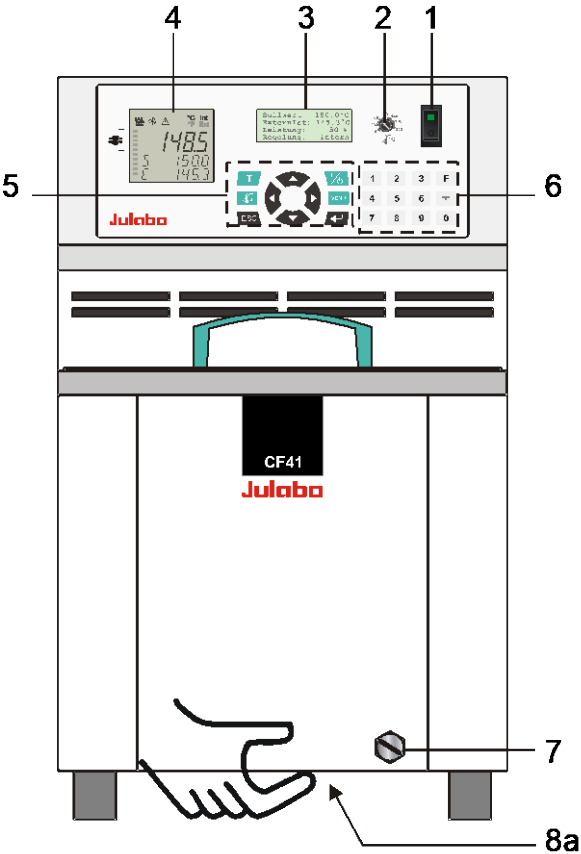

Rear view CF41/ CF31

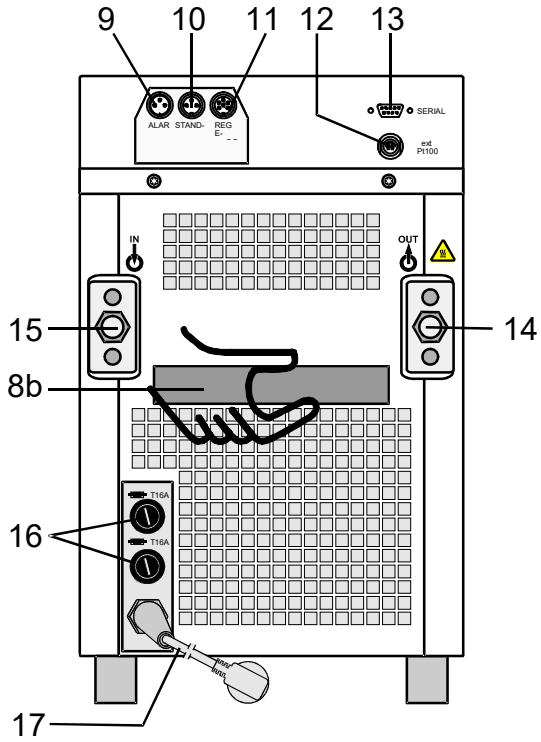
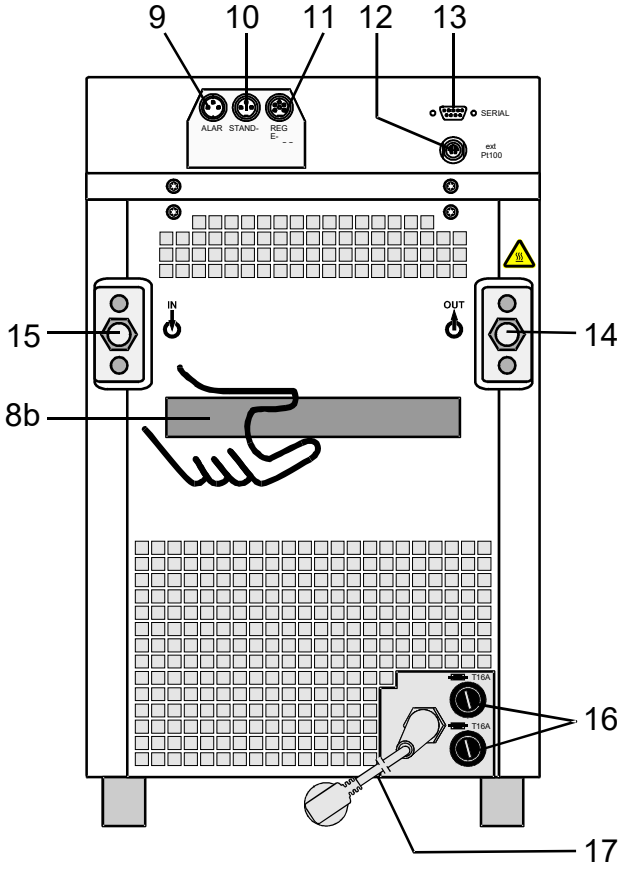

1



Mains power switch, illuminated

2  Adjustable excess temperature protection according to IEC 61010-2-010

3

Setpoint1:	150.00 °C
IntAct :	148.53 °C
Power :	80 %
Control :	intern

LCD DIALOG-DISPLAY
 Line 1: Setpoint and origin of setpoint programming
 (Key / RS232 or RS485 / ext. Pt100 / EProg)

RS232 :	150.00 °C
ExtAct :	145.30 °C
Power :	80 %
Control :	extern

 Line 2: Actual value - internal or external,
 identical to line 1 of the VFD-COMFORT-DISPLAY
 Line 3: Heating capacity in %.
 Line 4: Control type: internal / external

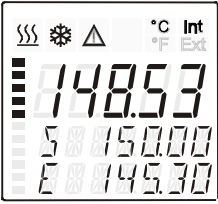
4  **VFD-COMFORT-DISPLAY**
 Header: Control indicators see sections 4.1 and 4.2
 Line 1: Actual value internal or external
 The display is depending on the selected control mode in the menu > Control < (internal or external).
 Line 2: Working temp. setpoint, constantly S xxx.xx
 Line 3: Actual value (E = external or I = internal)
 Alternating with the display in line 1



Use the keys ▼ ▲ to indicate further values in line 3. However, the functions of these keys are different with the programmer started.

- PI Capacity in % - with manipulated variable set to >control<*
- PS Capacity in % - with manipulated variable set to >serial<* or >eprog<*
- H Heater capacity in Watts
- U Mains voltage Volts
- F Flow rate in liters/minute
(providing EPROG input set to >Flowrate<)

*see >Configuration> page 33

4.1  Control indicators in the header:
 Heating / Cooling / Alarm /
Remote control

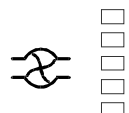
4.2  Control indicators in the header:
 Temperature indication **I**nternal or **E**xternal actual value
 Temperature indication in °C or °F (see page 36)

4.3  Display for the adjusted pump pressure stage in the -OFF- mode.
 Display for the effective pump pressure stage (rotation speed) after start.
 Four stages, adjustable via the  button, in the menu >PUMP<.

4.4  Segment at bottom blinks: Standstill of compressor
(compressor protection device, page 26)

5 Keypad 1



Start / stop key



Key for selecting the working temperature - Setpoint 1, 2, 3



Key for selecting the warning and safety values



MENU key - for selecting the menu functions



Cursor keys (left or right)



Edit keys (increase or decrease)



Enter key
1) Store value / parameter
2) Next lower menu level



Escape key
1. Cancel entries
2. Return to a higher menu level

6 Keypad 2



Numeral keypad: numerals 0 to 9



minus / decimal point



F key: Shows the help text in the LCD DIALOG-DISPLAY when alarm messages appear.

7 Drain port



8a







Handle: front

8b

Handle: rear

Option: Electronic module	Order No. 8 900 100
	The Cryo-Compact Circulator automatically recognizes the connected electronic module.
9  ALARM	Alarm output (for external alarm signal)
10  STAND-BY	Standby input (for external emergency switch-off)
11  REG+E-PROG	Programmer input and temperature recorder output

- 12  ext Pt100 Socket for external measurement and control sensor or external setpoint programming
- 13  SERIAL Interface RS232 / RS485: remote control via personal computer
- 14 Pump connection  OUT - pressure pump, M16x1
- 15 Pump connection  IN – suction pump, M16x1 (return)
- 16  Mains fuses: T16A
T20A (CF41 115 V / 60 Hz)
- 17 Mains power cable with plug

6. Preparations

6.1. Installation



- Place the unit on an even surface on a base made of **nonflammable** material.
- Cooling machine, pump motor and electronics produce intrinsic heat that is dissipated via the venting openings.! Never cover these openings!
- Be sure that the flow of ventilation can exit under the instrument.
- Keep at least 20 cm of open space on the side and rear of the unit.
- The place of installation should be large enough and provide sufficient air ventilation to ensure the room does not warm up excessively because of the heat the instrument rejects to the environment. (Max. permissible ambient temperature: 35 °C). For a fault (leakage) in the refrigeration system, the standard EN 378 prescribes a certain room space to be available for each kg of refrigerant.
The refrigerant quantity is specified on the type plate.
> For 0.423 kg of refrigerant R452A, 1 m³ of space is required.
> For 0.25 kg of refrigerant R134a, 1 m³ of space is required.
> For 0.357 kg of refrigerant R449A, 1 m³ of space is required.

Model CF41 with 0.17 kg filling quantity of refrigerant R452A = 0,4 m³ volume

Model CF41 with 0.15 kg filling quantity of refrigerant R449A = 0,42 m³ volume

Model CF31 with 0.15 kg filling quantity of refrigerant R134a = 0.6 m³ volume

- Do not set up the unit in the immediate vicinity of heat sources and do not expose to sun light.
- Before operating the unit after transport, wait about one hour after setting it up. This will allow any oil that has accumulated laterally during transport to flow back down thus ensuring maximum cooling performance of the compressor.

6.2. Temperature application to external systems

The Cryo-Compact Circulator is used for temperature application to external systems (loop circuit)



Caution: Securely attach all tubing to prevent slipping.



Notice: Flood hazard!

If the liquid levels in the Cryo-Compact Circulator bath and the external system are at different heights, overflowing must be prevented after the power has been turned off.

Return flow safety device

For this reason, shut-off valves can be integrated in the loop circuit.

Order No.	Description
8 970 456	Shut-off valve (suitable up to +90 °C)
8 970 457	Shut-off valve (suitable up to +200 °C)

Temperature application to external, closed systems

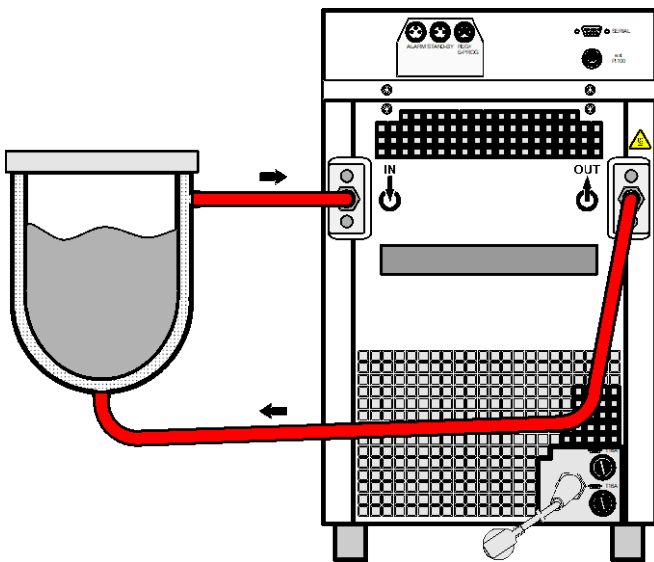

- Unscrew the M16x1 collar nuts on the pump connectors with a 19 mm (3/4") wrench and remove the sealing disks. Using the collar nuts, screw on the tubing connection fittings (for tubing 8 mm or 12 mm in diameter) delivered with the unit and tighten firmly. (Pressure pump: 14, suction pump: 15)
- Push on the tubings, and secure with tube clamps.
- Attach the tubing to the connectors of the external closed system, e.g., an instrument with a pressure-resistant temperature jacket or a temperature coil, and fasten with tube clamps to prevent slipping.

Tubing see page 22

Temperature application to external, open systems

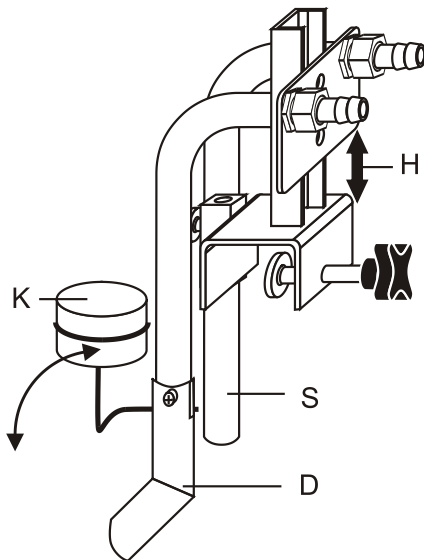

S = Suction pump connection
 D = Pressure pump connection
 K = Float
 H = Height adjustment

The Cryo-Compact Circulator is equipped with both a pressure and suction pump for external temperature application in open systems.

Differing flow rates of the pressure and suction pumps should be compensated. To maintain a constant liquid level, the JULABO „D+S“ Level Adapter is recommended for the external bath tank. The flow rate of the pressure pump will be then regulated by a built-in float device. The liquid level may be changed by a height adjustment on the „D+S“ Level Adapter.

Accessory: „D+S“ Level Adapter Order No. 8 970 410

Important:

- ① The liquid level should be equal in the internal and external baths (absolute height).
- ① If you take out samples (for example Erlenmeyer flasks) from the external bath, turn the Cryo-Compact Circulator off with the Start/Stop key.

6.3. Tubing



Warning: Tubing:

At high working temperatures, the tubing used for temperature control and for the cooling water supply represents a danger source.

A damaged tubing line may allow a large amount of hot bath fluid to be pumped out within a short time.

This may result in:

- Burning of skin
- Breathing difficulties due to hot atmosphere

Safety instructions

- Use suitable connecting tubing.
- Make sure that the tubing is securely attached.
- Avoid sharp bends in the tubing and maintain a sufficient distance from surrounding walls.
- Regularly check the tubing for material defects (e.g., for cracks), at least once a year.
- Preventive maintenance: replace the tubing from time to time.

Recommended tubing:

Order No.		Suitable for
8930008	1 m CR [®] -tubing 8 mm inner dia. (-20 ... +120°C)	CF31, CF41
8930012	1 m CR [®] -tubing 12 mm inner dia. (-20 ... +120°C)	CF31, CF41
8930108	1 m Viton [®] tubing 8 mm inner dia (-35 °C bis 200 °C)	CF31, CF41
8930112	1 m Viton [®] tubing 12 mm inner dia (-35 °C bis 200 °C)	CF31, CF41

Tubing insulation

8930410	1 m Insulation, 14 mm inner dia..	CR [®] -tubing 8 mm inner dia
8930412	1 m Insulation, 18 mm inner dia.	Viton [®] tubing 12 mm inner dia.

Tube clamps

8970480	2 Tube clamps, size 1	CR [®] -tubing 8 mm inner dia
8970481	2 Tube clamps, size 2	Viton [®] tubing 12 mm inner dia.

Metal tubing, flexible, triple insulated

8 930 209	0.5 m	2 fittings M16x1 female	-100 °C ... +350 °C
8 930 210	1.0 m		
8 930 211	1.5 m		
8 930 214	3.0 m		

Metal tubing, flexible, insulated

8 930 220	0.5 m	2 fittings M16x1 female	-50 °C to +200 °C
8 930 221	1.0 m		
8 930 222	1.5 m		
8 930 223	3.0 m		

6.4. Bath fluids



Caution:

Carefully read the material safety data sheet of the bath fluid used, particularly with regard to the fire point!

If a bath fluid with a fire point of ≤ 65 °C is used, only supervised operation is possible.

Water:

The quality of water depends on local conditions.

- Due to the high concentration of lime, hard water is not suitable for temperature control because it leads to scale in the bath
- Ferrous water can cause corrosion, even on stainless steel.
- Chlorinated water can cause pitting corrosion.
- Distilled water and deionized water are unsuitable. Their special properties cause corrosion in the bath, even on stainless steel.

Recommended bath fluids:



Bath fluid	Temperature range
soft/decalcified water	5 °C to 80 °C

See website for list of recommended bath fluids.
Contact: see page 6



Caution:

Fire or other dangers when using bath fluids that are not recommended:

Please contact JULABO before using other than recommended bath liquids. JULABO assumes no liability for damage caused by the selection of an unsuitable bath fluid.

Unsuitable bath fluids are fluids which, e.g.,

- are highly viscous
(much higher than 70 mm²/s at the respective working temperature)
- have a low viscosity and have creep characteristics
- have corrosive characteristics or
- tend to crack.

No liability for use of other bath fluids!

ATTENTION: The maximum permissible viscosity is 70 mm²/s

7. Operating procedures

7.1. Power connection



Caution:

- Only connect the unit to a power socket with an earthing contact (PE – protective earth)!
- The power supply plug serves as a safe disconnecting device from the line and must always be easily accessible.
- Never operate the unit with a damaged mains power cable.
- Regularly check the mains power cables for damage.
- We disclaim all liability for damage caused by incorrect line voltages!

Make sure that the line voltage and frequency match the supply voltage specified on the type plate.

7.2. Filling



Notice:

Pay attention to the thermal expansion of bath oil during heating to avoid overflowing of the liquid.

Guideline:

A volume change of 12 % per 100 °C temperature variation is to be considered.

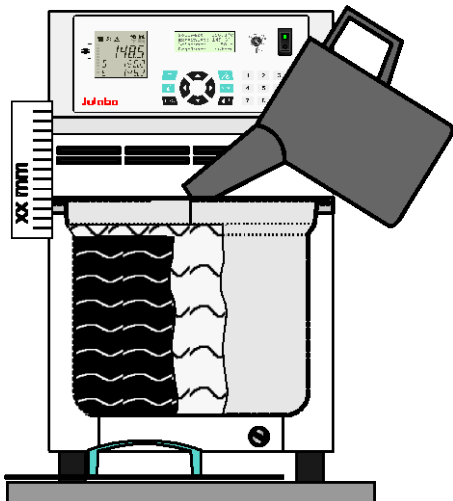

Take care that no liquid enters the interior of the Cryo-Compact Circulator .

- ① Connect the tubing from the external system to the pump connectors and check for leaks
- ① Check to make sure that the drain tap (7) is closed.

Recommendation:

For filling, use for example an measuring jug with nuzzle.

- ① Recommended maximum filling level with water as bath fluid:
30 mm below the tank rim
- ① Recommended maximum filling level with bath oils:
40 mm below the tank rim

- Turn the mains switch (1) on
(Switching on - see page 25)
- Switch on unit by pressing the start/stop key .
- Tempering fluid is pumped into the externally connected system.
Refill fluid up to recommended filling level.
- The Cryo-Compact Circulator is ready for operation.

Important:

- ① When using a bath fluid, the change in volume in case of change in temperature has to be respected. Fill in a little amount of bath fluid only so that the low level alarm is not triggered.
- ① Low level alarm is triggered at the following liquid level:
CF31 75 to 80 mm below the tank rim
CF41 80 to 85 mm below the tank rim
- ① When reaching the working temperature, check the liquid level. If the cooling coil is not completely covered with bath fluid, refill it.

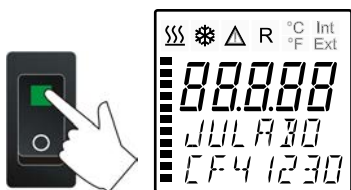
7.3. Switching on / Selecting the language

```

**** JULABO ****
*** HighTech ***
** Compact **
* Version 1.02-41 *

```

```

- OFF -
S 150.00
I 24.60

```

Switching on:

- The Cryo-Compact Circulator is turned on and off with the mains switch. The integrated control light will illuminate to indicate that power has been applied.
- ① During the self-test all segments of the VFD-Info-Display and the LCD DIALOG-DISPLAY light up.
Then the type of unit and the software version is indicated.
(example: **JULABO CF41 230** Volt / **Version 1.02-41.**)
The display „OFF“ or „R OFF“ indicates the unit is ready to operate.
- ① The Cryo-Compact Circulator enters the operating mode activated before switching the Cryo-Compact Circulator off:
keypad control mode (manual operation) or
remote control mode (operation via personal computer).

Selecting the language:

There are two options for the language of the LCD DIALOG-DISPLAY: German or English. Select the desired language in the menu >Configuration< under the submenu >Language/Sprache<.

```

Configuration
Off-Mode : pump off
>Language : english
Reset    : no

```

Press the respective keys in the following order:



8. Manual operation

8.1. Start - Stop

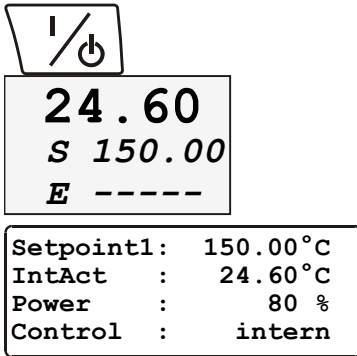

Start: Press the start/stop key .

The actual bath temperature is displayed on the VFD COMFORT-DISPLAY.

The LCD DIALOG-DISPLAY informs about adjustments and conditions on the Cryo-Compact Circulator (see example on the left).

Stop: Press the start/stop key .

The VFD COMFORT-DISPLAY indicates the message „OFF“.

Autostart: see chapter 9.1. Configuration

The Autostart function enables the start of the Cryo-Compact Circulator directly by pressing the mains switch or using a timer.

8.2. Control of the cooling machine

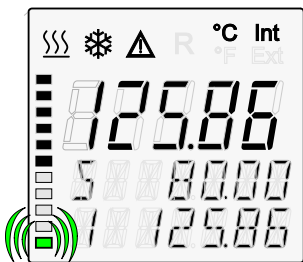

With the mains switch turned on, the circulator automatically switches the cooling machine off and on.

To ensure protection of the compressor, the software only switches the compressor on after a delay of 200 seconds.

If the controller requires cooling performance during standstill of the compressor, the segment at the bottom of the display blinks.

It is switched off, if:

- at internal control >Int<
the setpoint temperature is increased and the heat-up time calculated by the controller is longer than the intended time of compressor standstill (200 s).
- at external control >EXT<
the actual working temperature is increased by >5 °C

It is switched on, if:

- cooling is necessary for maintaining the bath temperature. (possibly after the 200 s time delay).

8.3. Setting the temperatures



Factory setting:

```
Setpoints
>Setpoint1: 20.00°C
Setpoint2: 37.00°C
Setpoint3: 70.00°C
```

Press the key to call up the menu for temperature selection.

3 different working temperatures are adjustable. Their values are freely selectable within the operating temperature range.

- This setting may be carried out with the circulator being in the Start or Stop condition!

Example: Setting working temperature „Setpoint 3“

```
Setpoints
Setpoint1: 20.00°C
Setpoint2: 37.00°C
>Setpoint3: 70.00°C
```

1. Press the key.
The LCD DIALOG-DISPLAY indicates the valid settings.
2. Use the keys to select Setpoint 3.
(One segment of the line blinks)

Change the value to 85 °C.

```
Setpoints
Setpoint1: 20.00°C
Setpoint2: 37.00°C
>Setpoint3: 85.00°C
```

3. Use the numeral keypad to enter 8 and 5.
Then press enter to store the value.
The value remains visible on the LCD DIALOG-DISPLAY for about 10 seconds, or press to update the display immediately.



```
25.83
S 85.00
E -----
```

- In the >Start< condition this value is immediately used for controlling the working temperature.
The indication on the VFD COMFORT-DISPLAY is updated.
The heater control indicator blinks.



Notice: See **SetMax:** and **SetMin:** in chapter 9.6.Limits on page 57

Example: Selecting the working temperature



- Press the key. Use the keys to select setpoint 1, 2 or 3 and press enter .

- The Cryo-Compact Circulator uses the new working temperature value for temperature control.

8.4. Safety installations, warning functions



Check the safety installations at least twice a year! (See page 14)

8.4.1. Excess temperature protection

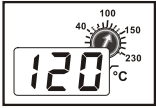



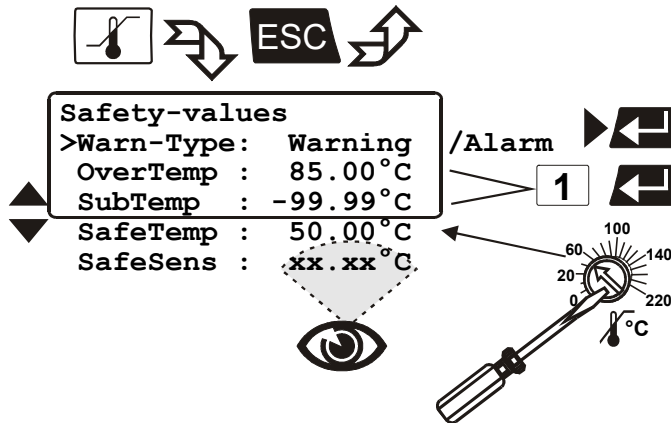

Settings for the excess temperature protection according to IEC 61010-2-010 and for the high and low temperature warning functions are made

in a menu that is called up with the key .

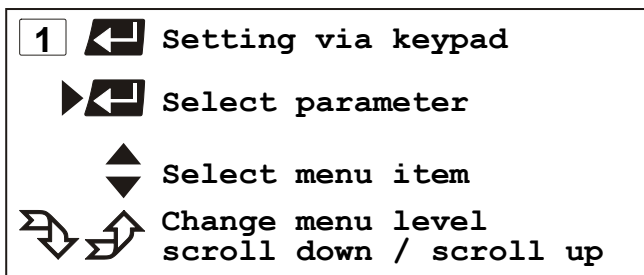



Legend:



1. Press the key .
The LCD DIALOG-DISPLAY shows the valid settings (see example above).
2. Use the keys   to select the menu item.

Settings:

Warn-Type: Select the parameter with the key  and press enter  (warning or alarm).

OverTemp and SubTemp: Use the numeral keypad to enter the value and press enter .

SafeTemp: Set the new cut-out value using a screwdriver via the LCD DIALOG-DISPLAY. (Example: 50 °C)

The value remains visible on the LCD DIALOG-DISPLAY for about 10 seconds, or press  to update the display immediately.

Example:

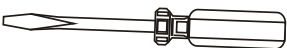

Recommendation:

Set the excess temperature protection >SafeTemp< at 5 to 10 °C above the working temperature setpoint.



Warning:



The excess temperature protection >SafeTemp< should be set below the flash point of the bath fluid used.
 In the event of wrong setting there is a fire hazard!
 We disclaim all liability for damage caused by incorrect settings!

Warn-Type: >Warning< or >Alarm<

For the two menu items >OverTemp< and >SubTemp< choose between a warning message being signaled or a complete shutdown of the main functional elements such as heater and circulating pump being effected.

OverTemperature: SubTemperature:

If for a sensitive temperature application task adherence to a working temperature value >Setpoint< is to be supervised, then set high and low temperature warning values.
 In the example below, the >Setpoint< of 85 °C is surrounded by the values >OverTemp< 87 °C and >SubTemp< 83 °C. The electronics immediately registers when the actual temperature attains a temperature out of the limits and it follows a reaction according to what is set in the menu item >Warn-Type<.

Warn-Type: >Warning<

An audible warning (interval tone) sounds and a message appears on the VFD COMFORT-DISPLAY.

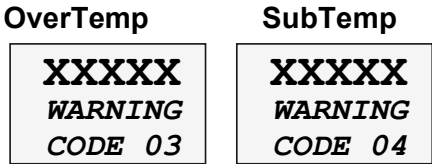

Press **F** for help on the LCD.

Actual temperature above high temperature value.

Actual temperature below low temperature value.

Warn-Type: >Alarm<

A complete shutdown of heater and circulating pump is effected.
 An audible alarm (continuous tone) sounds and a message appears on the VFD COMFORT-DISPLAY.

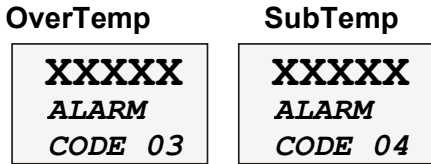

Press **F** for help on the LCD.

Actual temperature above high temperature value.

Actual temperature below low temperature value.

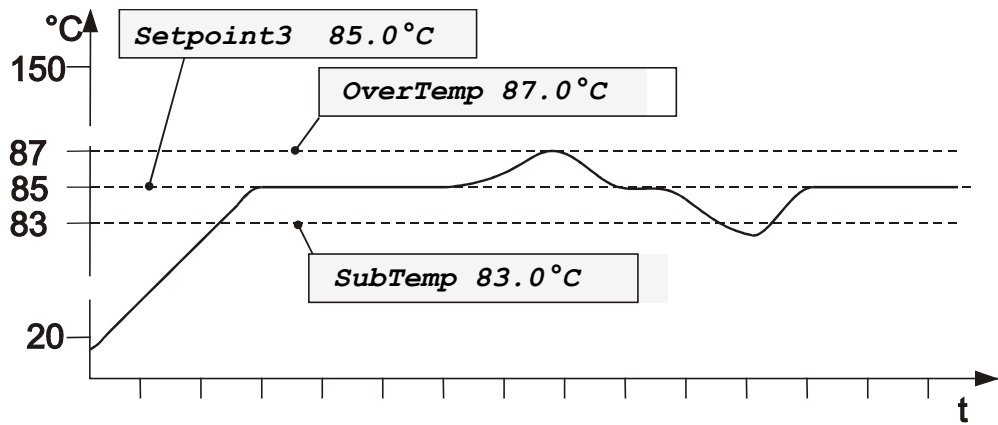

ⓘ The warning functions are only triggered when the actual bath temperature, after start from the „OFF“ or „rOFF“ mode, lies within the set limits for 3 seconds.

SafeTemperature: Indicated is the cut-out value set with a screwdriver on the excess temperature protection device.

Setting range:
20 °C ... 220 °C

This safety installation is independent of the control circuit. When the temperature of the bath fluid has reached the safety temperature, a complete shutdown of the heater and pump is effected.

The alarm is indicated by optical and audible signals (continuous tone).

The following error message appears on the VFD COMFORT-DISPLAY:

XXXXXX
ALARM
CODE 14

Press **F** for help on the LCD

Working temperature
exceeds the adjusted
safety temperature.



SafeSens: Indicated is the temperature value of the safety sensor.

8.4.2. Early warning system, low level protection

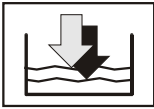

(patented)

This low level protection is independent of the control circuit and is divided in two sections.

1. Switch in stage 1 recognizes a critical fluid level 😊.

An audible warning (interval tone) sounds and a message appears on the VFD COMFORT-DISPLAY

XXXXXX WARNING CODE 40	Press F →	Niveau level warning Critical fluid level Replenish the bath tank with bath fluid
---	------------------	--

Refill bath fluid!

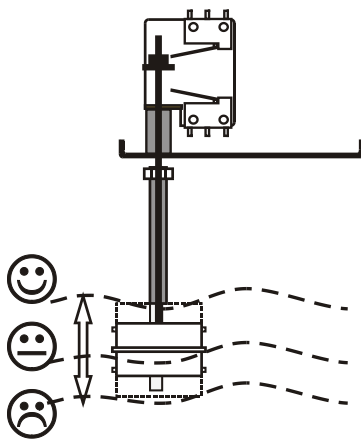

2. Switch in stage 2 recognizes a low fluid level ☹️.

If stage 2 of the low level protection device (according to IEC 61010-2-010) is triggered, a complete shutdown of the heater and circulating pump is effected.

A continuous alarm tone sounds and a message >ALARM< >CODE 01< appears on the VFD COMFORT-DISPLAY.

XXXXXX ALARM CODE 01	Press F →	Insufficient liquid level or float is defective.
---	------------------	--

Turn off the unit with the mains switch, refill bath fluid and turn the unit on again!

Important: Check the safety installations from time to time.



Caution:

When adding bath fluid, always use the same bath fluid type that is already in the bath. Bath oils must not contain any water and should be pre-heated approximately to the current bath temperature!

Explosion hazard at high temperatures!

9. Menu functions

The term „menu functions“ refers to adjustments such as

- Configuration of the Cryo-Compact Circulator
- Internal and external control with adjustable control parameters
- Start menu for the integrated programmer
- Integrated programmer; 6 profiles with 60 sections each
- Configurable inputs and outputs; analog recorder outputs, input for external programmer or manipulated variable or flow rate
- Determination of limits for all important setting ranges and capacity variables
- Online communication, with adjustable interface parameters
- Absolute temperature calibration; sensor calibration
- Electronically adjustable pump capacity

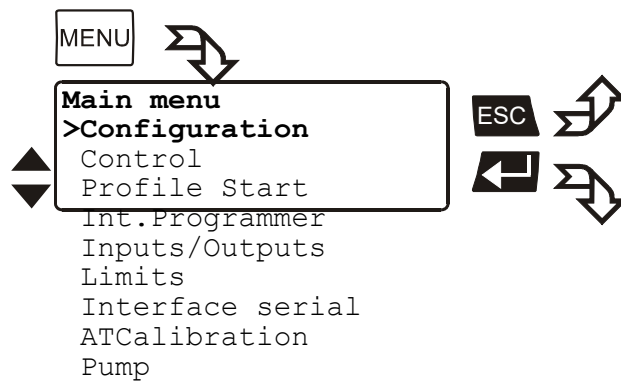

- ❗ If the electronic module is not fitted, the item >inputs/outputs< will be missing in the menu.

Legend

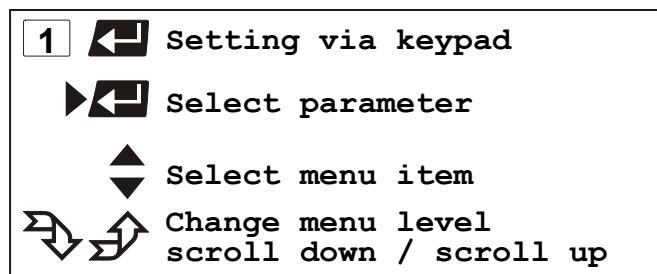

1. If you press , use the keys to move in menu level 1.
2. If the desired menu item is highlighted on the LCD DIALOG-DISPLAY (>), press enter to change to menu level 2.

9.1. Configuration

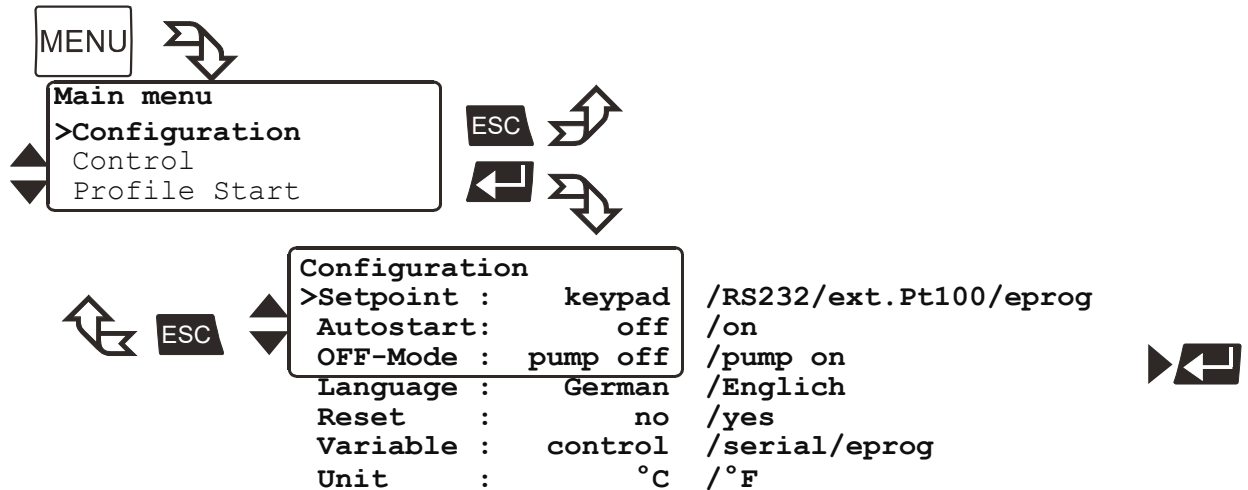

1. Use the up/down keys to select the desired menu item.
2. Use the left/right keys to select the parameter (parameter blinks).
3. Press enter to store the new parameter.

Setpoint

The Cryo-Compact Circulator provides four possibilities for setpoint setting. The selected mode is indicated in line 1 on the LCD DIALOG-DISPLAY.

Possible parameters:

```
Setpoint1: 150.00°C
IntAct    : 148.53°C
Power     : 80 %
Control   : intern
```

keypad – Setpoint setting via keypad or via the integrated programmer.
(factory setting)

```
RS232    : 150.00°C
ExtAct   : 145.30°C
Power    : 80 %
Control  : extern
```

RS232 or RS485 - Setpoint setting via the serial RS232/RS485 interface through a PC or superordinated data system.

In the header of the VFD COMFORT-DISPLAY an „R“ illuminates. It indicates that remote control mode is set.



i RS232 or RS485: see menu > Serial interface < page 59.

```
-OFF-
S  xxxx
I  xxxx
```

Important:

Connect the Cryo-Compact Circulator to a PC using an interface cable. Check the interface parameters of both interfaces (on Cryo-Compact Circulator and PC) and make sure they match.
(see 12.1. on page 69)

```
Pt100    : 150.00°C
ExtAct   : 145.30°C
Power    : 80 %
Control  : extern
```

ext.Pt100 – Setpoint setting via the analog socket „ext. Pt100“ using an external temperature sensor or an appropriate voltage/current source.

eprog	:	50.0°C
IntAct	:	24.7°C
Power	:	80 %
Control	:	intern

eprog – Can only be adjusted when an electronic module with analog connections is used (option).
Setpoint setting via the analog interface REG+E-PROG connection with an external voltage or current source or a programmer.

Important:

Connect the external voltage or current source or a programmer to the circulator via the socket REG+E-PROG (see page 52).
In the menu >Inputs/Outputs< set the parameter >EPROG< and the input variables (see page 53).

The E-Prog input can only be used either under menu item >**Setpoint**< or under menu item >**Variable**< (page 35).

Autostart

Possible parameters:

on - AUTOSTART on

off - AUTOSTART off (Factory setting)

Note:

The temperature system has been configured and supplied by JULABO according to N.A.M.U.R. recommendations. This means for the start mode, that the unit must enter a safe operating state after a power failure (non-automatic start mode). This safe operating state is indicated by „ **OFF** „, resp. **R OFF** on the VFD-COMFORT-DISPLAY. A complete shutdown of the main functional elements such as heater and circulating pump is effected simultaneously.

The values set on the Cryo-Compact Circulator remain stored, and the unit is returned to operation by pressing the start/stop key (in manual control mode). In remote control mode, the values need to be reset by the PC via the interface.

Should such a safety standard not be required, the AUTOSTART function (automatic start mode) may be activated, thus allowing the start of the instrument directly by pressing the mains power switch or using a timer.

ⓘ The AUTOSTART function can only be used, if setpoint setting is carried out via >keyboard< or >eprog< or >ext. Pt100<.



Warning:

For supervised or unsupervised operation with the AUTOSTART function, avoid any hazardous situation to persons or property.

The instrument does no longer conform to N.A.M.U.R. recommendations.

The safety and warning functions of the instrument should always be used to their fullest capacity.

OFF-Mode

Normally the circulating pump is switched via the start/stop signal. However, if circulation should be maintained also for the -OFF- condition, the parameter **>ump on<** needs to be set.

Possible parameters:

ump off (factory setting)

ump on

Language

There are two options for the language of the LCD DIALOG-DISPLAY: German or English.

Possible parameters:

deutsch / englisch German / English

Reset

Use this to reset all values to factory setting (except date and time).

Possible parameters:

yes

no (factory setting)

Variable - actuating variable

The variable corresponds to the extent to which the heater or cooling machine of the Cryo-Compact Circulator is controlled. Heat or cold is applied to the bath according to this variable. If this happens with the control electronics of the Cryo-Compact Circulator, called **>control<** in this particular case, the bath temperature is exactly heated and maintained constant at the adjusted setpoint.

❗ Programming of variables for the parameters **> serial <** or **> eprog <** is only accepted, if the unit is in Start mode.

Possible parameters:

control – The internal control electronics of the Cryo-Compact Circulator controls the heater and cooling machine. Self-tuning is possible.

serial – The heater or cooling machine receives the control signal via the serial interface. Self-tuning is not possible.

eprog - The heater or cooling machine receives the control signal via the E-Prog input. Self-tuning is not possible. (option).

Important:

Set the parameter **>EPROG<** and the input variables also in the menu **>Inputs/Outputs<** (see page 53).

Note:

The E-Prog input can only be used either under menu item **>Setpoint<** (page 33) or under menu item **>Variable<** (see above).



Warning:

The working temperature range of the Cryo-Compact Circulator is determined during configuration. If set to >Control<, this range cannot be exceeded.

If set to > **serial** < and > **eprog** <, heat or cold is applied to the bath without control.

The permissible maximum temperature can be exceeded. The user has to take adequate precautions for temperature control.

Materials, such as gaskets or insulations for example, may be damaged or destroyed, if the permissible maximum temperature is exceeded.

The safety and warning functions of the instrument should always be used to their fullest capacity. (See page 28)

Unit

Temperature values can be displayed in the unit °C or °F.

With this change all adjusted temperature values are converted and displayed into the new unit.

Example:

```
Setpoints
>Setpoint1: 20.00°C
Setpoint2: 37.00°C
Sezpoint3: 70.00°C
```

°C → °F ↓

```
Setpoints
>Setpoint1: 68.00°F
Setpoint2: 98.60°F
Setpoint3: 158.00°F
```



```
-OFF-
S  xxxx
I  xxxx
```

Possible parameters:

°C (factory setting)

°F

9.2. Control

The Cryo-Compact Circulator is conceived for internal and external temperature control. Switching is carried out in this submenu. Depending on what is set, only the respective set of parameters is indicated.

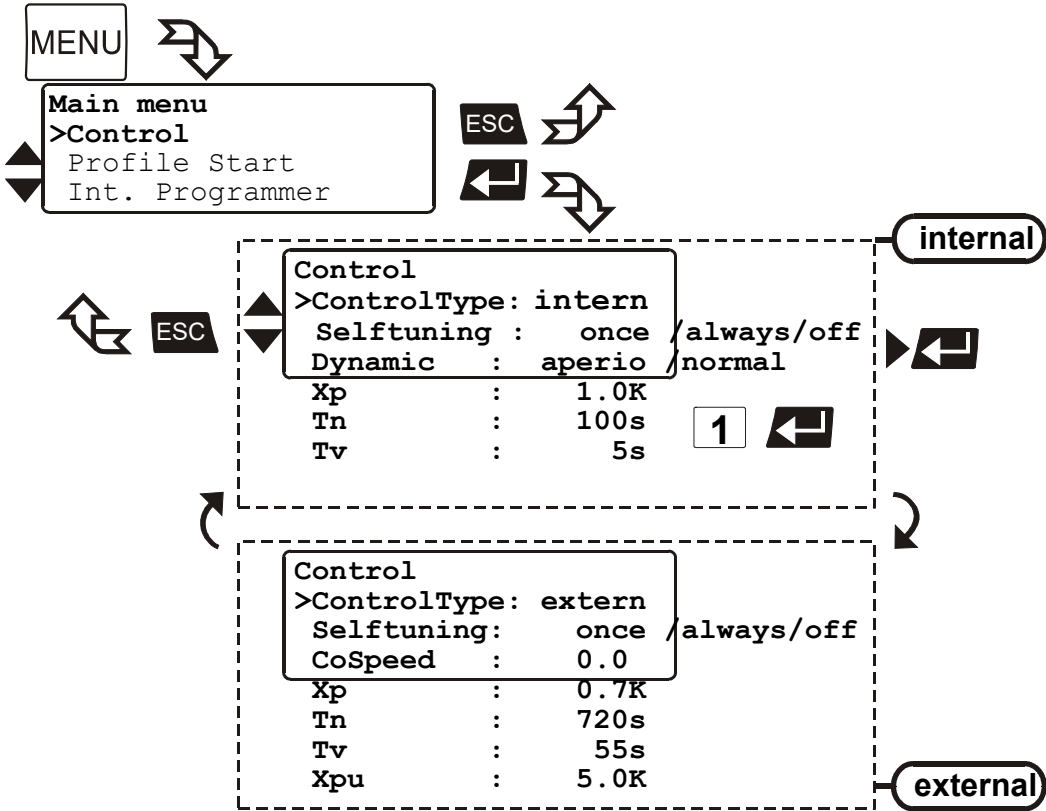

1. Use the keys to select the menu item.
2. With the keys select the parameter (parameter blinks) or use the numeral keypad to enter the numbers (number segment blinks).
3. Press enter to store the new parameter or value.

Example: 0.8

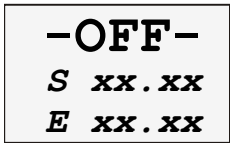

ControlType: Can only be adjusted in the -OFF- condition

Possible parameters:

- intern** internal temperature control
- extern** external temperature control with external Pt100 sensor

IMPORTANT:

Additional measures for external temperature control.

- ❗ For external control and temperature measurement an external Pt100 sensor must be connected to the socket (7) on the rear of the Cryo-Compact Circulator .



- ① Sensor calibration of the external Pt100 sensor is carried out in the menu >ATCalibration<, with the > Status< set to >no< (see page 60).
- ① Suggested adjustments for external temperature control: AreaUp/ AreaDown and IntMax / IntMin see chapter >Limits< on page 57.
- ① External temperature control does not allow for setpoint setting via the socket „ext. Pt100“ (see page 33).

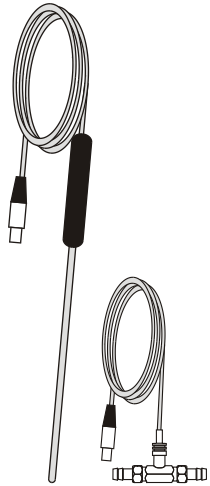

Pt100

M+R

Accessory: Pt100 external sensor

Order No.	Description	Material	Cable
8981003	200x6 mm Ø,	stainless steel	1.5 m
8981005	200x6 mm Ø,	glass	1.5 m
8981006	20x2 mm Ø,	stainless steel	1.5 m
8981010	300x6 mm Ø,	stainless steel	1.5 m
8981015	300x6 mm Ø,	stainless steel / PTFE coated	3 m
8981013	600x6 mm Ø,	stainless steel / PTFE coated	3 m
8981016	900x6 mm Ø,	stainless steel / PTFE coated	3 m
8981014	1200x6 mm Ø,	stainless steel / PTFE coated	3 m
8981103	Extension cable for Pt100 sensor		3.5 m
8981020	M+R in-line Pt100 sensor		

The M+R in-line Pt100 sensor is a flow sensor and can be installed loop circuit



Notice:

Place the external sensor into the bath medium and securely fix the sensor.

Selftuning:

When performing an selftuning for the controlled system (temperature application system), the control parameters Xp, Tn and Tv are automatically determined and stored.

Possible parameters:

off - no selftuning.

The control parameters ascertained during the last identification are used for control purposes.

once – single selftuning (factory setting)

The instrument performs a single selftuning of the controlled system after each start with the start/stop key  or after receiving a start command via the interface.

always – continual selftuning

The instrument performs a selftuning of the controlled system whenever a new setpoint is to be reached.

Use this setting only when the temperature application system changes permanently.

Dynamic:

This parameter affects the temperature pattern only in case of **internal** control.

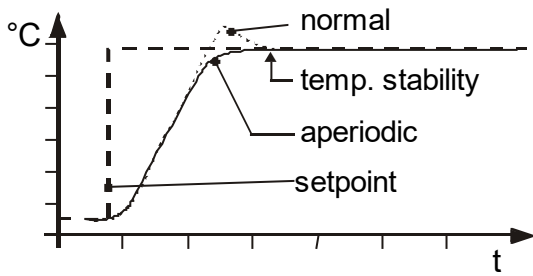

Possible parameters:

normal –Allows for reaching the setpoint faster, but overshooting of up to 5 % is possible.

aperiodic – (factory setting)

Target temperature is attained without overshooting.

i With both adjustments an adequate temperature stability is reached after approximately the same time.

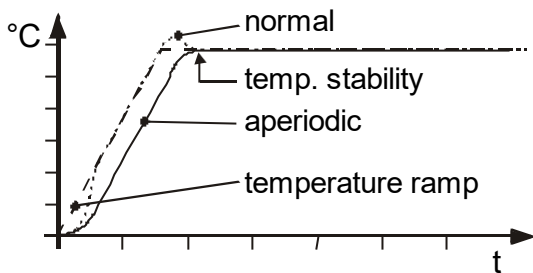

CoSpeed:

This parameter affects the temperature pattern only in case of **external** control.

Possible parameters: 0 ... 5

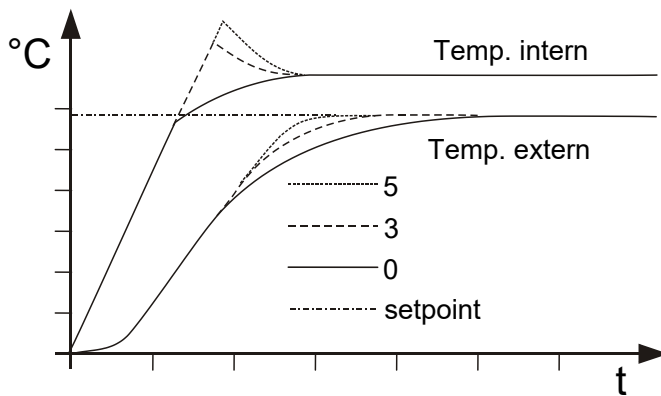

During selftuning, the control parameters X_p , T_n and T_v of a controlled system are automatically determined and stored. Depending on the controlled system, time for tuning can be unequally longer. This controller layout allows protection of sensitive objects requiring temperature application.

As soon as a co-speed factor is set, it is considered for calculating the control parameters. As shown in the diagram, tuning times become shorter the higher the co-speed factor is, but overshooting can happen in the internal system.

Control parameters – intern / extern

The control parameters preset in factory are in most cases adequate for achieving an optimum temperature pattern for the samples requiring temperature application.

Each parameter may be manually set via the keypad if necessary, to allow optimum control performance.

Setting range:
internal / external
0.1 ... 99.9 K

Proportional range > X_p <

The proportional range is the range below the selected temperature value in which the control circuit reduces the heating power from 100 % to 0 %.

Setting range:
internal / external
3 ...9999 s

Resetting time >Tn< (Integral component)

Compensation of the remaining control deviation due to proportional regulation. An insufficient resetting time may cause instabilities to occur. Excessive resetting time will unnecessarily prolong compensation of the control difference.

Setting range:
internal / external
0 ... 999 s

Lead time >Tv< (Differential component)

The differential component reduces the control settling time. An insufficient lead time will prolong the time required to compensate for disturbance effects and cause high overshooting during run-up. An excessive lead time could cause instabilities (oscillations) to occur.

Setting range:
0.1 ... 99.9 K

Proportional range >Xpu<

The proportional range Xpu of the cascaded controller is only needed for external control.

Optimization instructions for the PID control parameters:

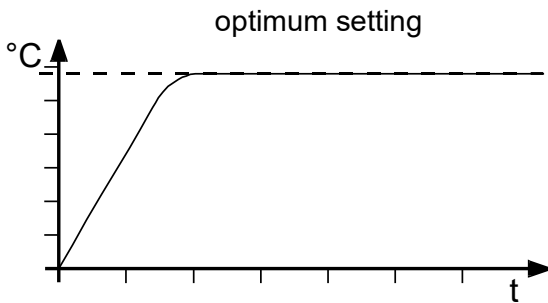

The heat-up curve reveals inappropriate control settings.

Inappropriate settings may produce the following heat-up curves:

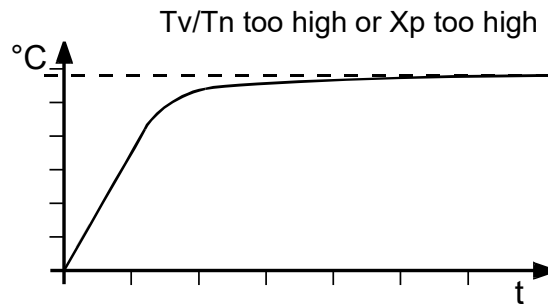
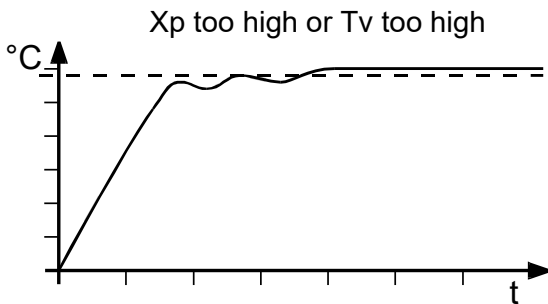
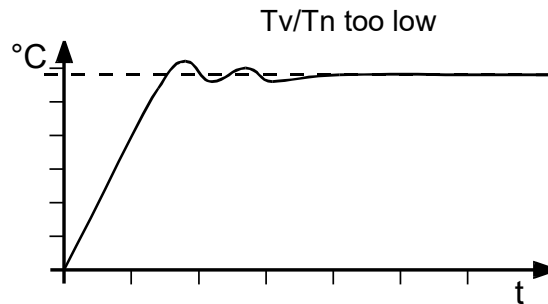
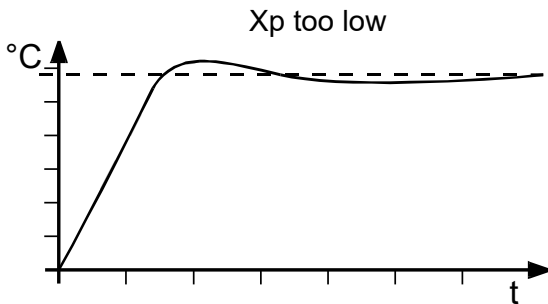

9.3. Start of a profile

The start menu of the integrated programmer allows calling up and defined starting of one of six previously stored temperature profiles. The profiles are started manually or via the integrated timer.

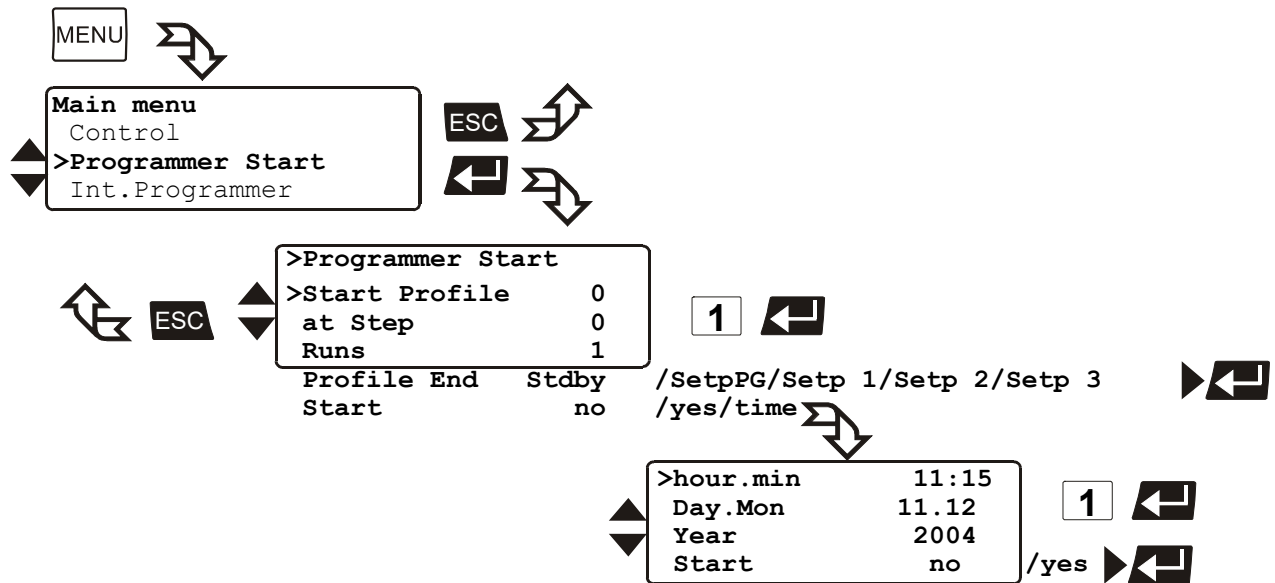

Example: 11:15

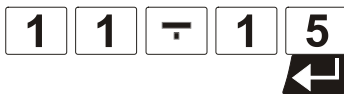

1. Use the keys to select the menu item.
 2. With the keys select the parameter (parameter blinks) or use the numeral keypad to enter the numbers (number segment blinks).
 3. Press enter to store the new parameter or value.
- ① If the parameter **time** is selected, a further submenu opens for setting the start time.

Possible parameters:

Start Profile 1 to 5

Select the profile that should be started.

at Step 1 to 60.

Select the section with which the profile should be started.

Runs 1 to 99

Select the number of profile repetitions.

Start no / yes ⇒ (manual start)

or



time ⇒ (via integrated timer)

Profile End Stdby / SetpPG / Setp 1 / Setp 2 / Setp 3

This parameter is used to determine if the unit switches to the -OFF- condition at the end of a profile, or if temperature control is continued and the working temperature setpoint that is be used in such case.

Stdby – If the end of the profile is reached, the Cryo-Compact Circulator switches to the -OFF- condition. The VFD display indicates the working temperature setpoint, that was displayed in line 2 already before the program was started (example: S 25.00 °C).

SetpPG – (Setpoint of the **Pro**Grammer) At the end of the profile, the setpoint of the last program section is written to the position of setpoint 3 (example: 80.00 °C) and indicated in line 1 of the LCD display. The Cryo-Compact Circulator operates and controls this temperature until the Start/Stop key  is pressed or a new profile is started.

Setp 1, Setp 2, Setp 3 – („Setp“ short for **Setpoint**) Before starting the programmer, a temperature value is set for one of the three setpoints in the  menu. (example: Setpoint 2 58.00 °C) The Cryo-Compact Circulator operates and controls this temperature at the end of the profile until the Start/Stop key  is pressed or a new profile is started.

Examples:



Setpoint3:	80.00°C
IntAct :	80.00°C
Power :	2%
Control :	intern

Setpoint	
Setpoint1:	25.00°C
>Setpoint2:	58.00°C
Setpoint3:	85.00°C

Setpoint2:	58.00°C
IntAct :	60.00°C
Power :	0%
Control :	intern

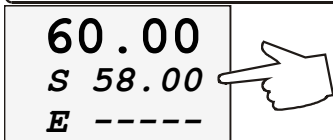

Start no / yes ⇒ (manual start)
 or
time ⇒ (via integrated timer)

When selecting the parameter **time**, a new submenu is called up for entry of the start time.



A flashing segment indicates that a start time needs to be entered.

hour.min Start time
Day.Mon day and month
Year year

Set each entry with enter .

Start no / yes

A flashing line indicates that the parameter „yes“ needs to be entered.

Press the key  to select the parameter and press enter .

Starttime:	06:00
Date :	15:12
*** wait ***	
Acttime	02:34:45

The temperature system switches to waiting mode and a flashing line „wait“ appears on the LCD DIALOG-DISPLAY. The start time and actual time are permanently indicated on the display.

Indication after successful start:

The started programmer displays the actually calculated setpoint in line 1. The value changes until the final temperature of the section is reached (temperature ramp).

Examples:

```
Setp. :    125.8°C
IntAct:    124.7°C
Prof. :    4 Step: 12
Remain:    00:03:45
```

```
Setp. :    125.8°C
IntAct:    124.7°C
Prof. :    4 Step: 12
All :      00:03:45
```

```
Setpoint :    125.8°C
IntAct :    124.7°C
Prof :      4 Step:12
S12:150:00 h:m 01:10
```

```
Edit
>Edit Profile:    4
Step:             12
Setp:             150.00°C
Time [hh:mm]     01:10
```

1st line: Setpoint of the programmer

2nd line: Actual temperature value
at **internal control** = IntAct: xxx.xx
at **external control** = ExtAct: xxx.xx

3rd line: Selected profile and the actual section (step).

4th line: With the keys ▼ ▲ the following information can be displayed in line 4.

- Remaining time of the actual section (standard display)
- Remaining total time: Profile x number of repetitions
(All: Days/hours:minutes:seconds)

Particularitys:

1. If a total time of more than 999 days is calculated, only the hours are displayed on the unit.
(All: hours:minutes:seconds)
2. If the time period of a section is edited after start, then the remaining total time can no longer be displayed.

- The data of a section as stored under „Edit Profile“.

Use the keys ◀ ▶ to successively indicate the sections of a profile. Unused sections or incorrect data are skipped.

9.3.1. Edit after start

A JULABO programmer of generation II allows editing of a running profile. A programmer of the previous generation requested the profile to be interrupted, edited and then started again.





Start and quit the edit mode:

```
Edit
>Edit Profile:    1
Step:            6
Setp:            100.00°C
Time [hh:mm]     01:05
```

- After start, press the  key to enter the submenu „Edit Profile“.

Press  to quit the edit mode.

Deleting a complete section:

- Use the keys   to move to line 2.
- Use the keys   to choose the desired section.
- Press the  key to delete the complete section.

```

Edit
>Edit Profile:      1
**Step is deleted **
Setp:              °C
Time [hh:mm]
    
```

If the desired section is already chosen, the section is deleted even if the cursor > is in line 1, 3 or 4.

Deletion is indicated in the respective line of the LCD display:
 ** Step is deleted **



```

Edit
>Edit Profile:      1
** Step is active **
Setp:              100.00°C
Time [hh:mm] 01:05
    
```

The section that is currently processed cannot be deleted. If you still try it, the message **** Step is active **** appears on the LCD display.

Changing a section:



i The values in lines 3 and 4 can be changed, even on the section that is currently processed.

- In the input window, select the menu item with the keys  .
- Use the numeral keypad to enter the numbers and press enter .

```

Edit
Step:              6
>Setp:            83.00°C
time [hh:mm] 01:25
    
```

Examples:

Setpoint: target temperature 83 °C   
Time time period 1 hour:25 minutes
     

Particularity for changes in a section that is currently in process.

- i** If the target temperature is changed, the slope of the ramp is automatically calculated on basis of the remaining time of the section.
- i** If the time period is changed, the slope of the ramp is automatically calculated on basis of the new total time of the section.

9.3.2. Interrupting a profile

```
Setp. :    125.80°C
IntAct:    124.70°C
Prof. :    4 Step:12
*** pause ***
```

- ① Press the start/stop key  to interrupt or continue a profile. The setpoint and time period set for the corresponding section are thus stopped at the values presently achieved. The instrument is put on hold and the message „pause“ flashes on the LCD DIALOG DISPLAY.

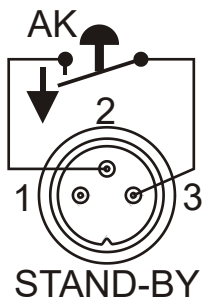

```
Setp. :    xxx.xx°C
IntAct:    xxx.xx°C
Prof. :    4 Step:12
*** STAND-BY ***
```

- ① A profile can be interrupted or restarted by an external emergency shut-off.
Important: For this, in the menu >Inputs/Outputs< the menu item >Ext. StBy < must be set to >activ< (see page 55) and in the menu >Configuration< >Autostart< needs to be set (see page 34).
- ① Setpoint control and timer are interrupted by breaking the contact „AK“. The instrument is put on hold and the message „Stand-By“ flashes on the LCD DIALOG-DISPLAY.

 **Notice:** This is not an actual emergency switch-off.



Warning:

Following a power interruption, it would be possible in this condition for the instrument to restart automatically. The safety and warning functions of the instrument should always be used to their fullest capacity. See **Warning** page 34.

9.3.3. Interruption after a power failure

There is every possibility to operate the programmer safe to power failures.

Important: For this in the menu >Configuration< >Autostart< needs to be set (see page 34).

- ① If the AUTOSTART function is activated, the programmer starts again at a point approx. 20 seconds before the interruption took place. However, an uncontrolled change of the bath temperature happened.
- ① Power failure when the instrument is on hold if start is effected via the built-in timer:
If the starting time is not yet reached, the programmer is put on hold again.
If the starting time is exceeded, the programmer starts immediately.

```
Starttime: 06:00
Date :    15:12
*** wait ***
Acttime 02:34:45
```

9.3.4. Termination of a profile

```

Setp :    125.80°C
IntAct:   124.70°C
Prof. :    4 Step:12
Remain:   00:03:45
    
```



```

Programmer Start
>Start Profile      x
  at Step           x
  Runs              1
  Start             no
    
```

① A profile can be terminated by pressing **ESC**. The programmer switches back to the Start menu.

- Press **ESC** again to quit the menu or use the keys **▼ ▼ ▲ ▲** to remain in the Start menu.

The start of another temperature profile can now be prepared if necessary.

Example:

```

Setpoint1: 150.00°C
IntAct :    83.24°C
Power :     0 %
Control :   intern
    
```

```

-OFF-
S 150.00
E -----
    
```

Interruption after a power failure

In case of a power failure, the reaction of the Cryo-Compact Circulator is the same as when switched off and on again with the mains switch.

The LCD DIALOG-DISPLAY gives information on the adjustments and conditions of the Cryo-Compact Circulator .

The VFD COMFORT-DISPLAY indicates "OFF".

9.4. Integrated programmer

The integrated programmer allows any desired temperature program sequences to be realized. Such a temperature sequence is called profile. A profile consists of individual sections defined by duration (t:) and target temperature. Target temperature is the setpoint (T:), that is achieved at the end of a section. The programmer uses time and temperature difference values within a section to calculate a temperature ramp.

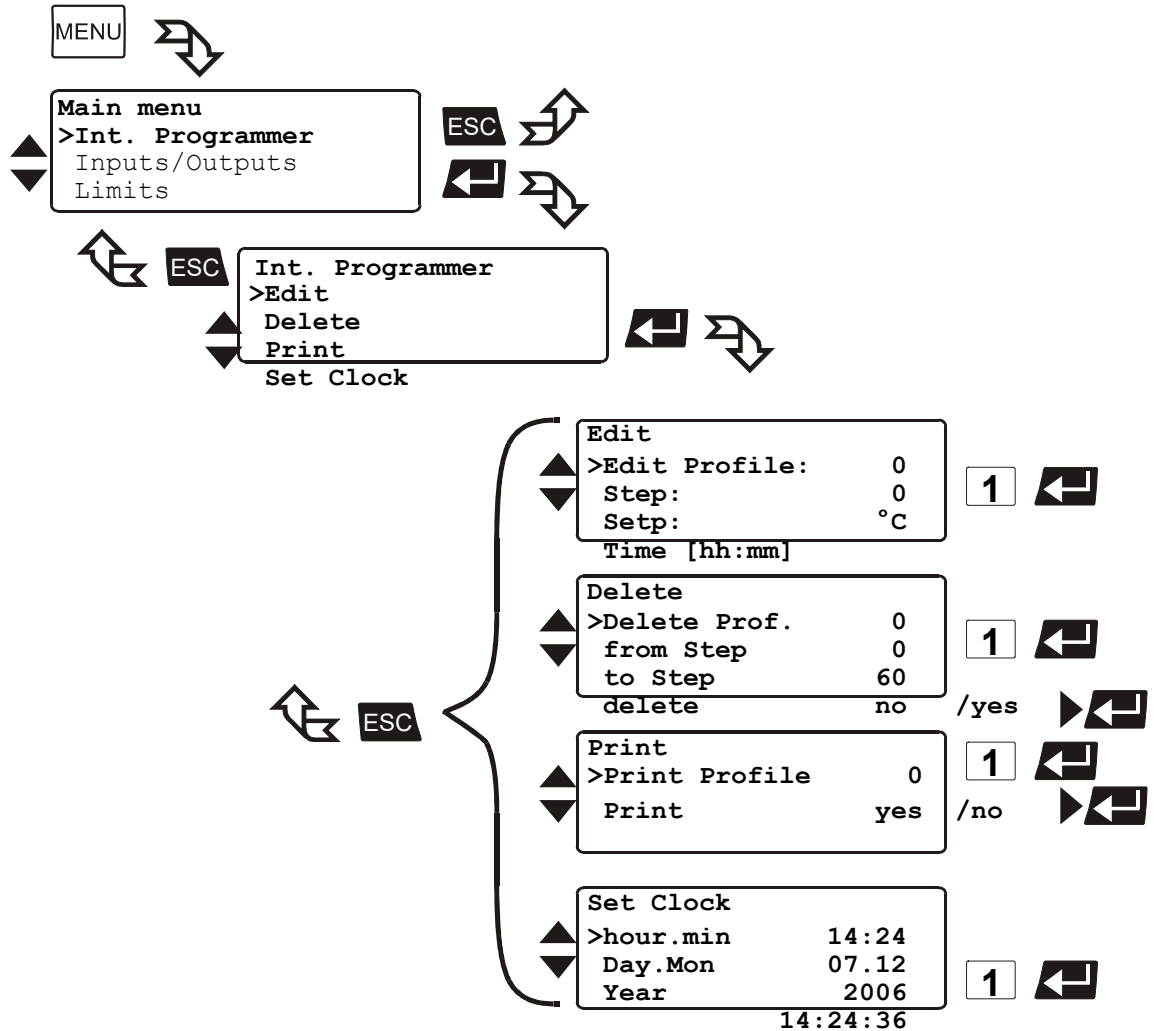

1. Use the keys ▼ ▲ to select the desired menu item in menu level 2 on the LCD DIALOG-DISPLAY (>) and press enter ↵ to change to menu level 3. An input window opens for each menu item.
2. In the input window, select the menu item with the keys ▼ ▲.
3. Use the keys ◀ ▶ to select the parameter (parameter blinks) or use the numeral keypad to enter the numbers (number segment blinks).
4. Press enter ↵ to store the new parameter or value.

Menu functions

```

Int. Programmer
>Edit
Delete
Print
Set Clock
    
```

Edit Compile profiles
 Display sections
 Important: Also a running profile can be changed.
 See „Edit after start“ page 43

Delete Delete sections

Print Print a programmed profile

Set clock Set the real time on the instrument

Compile profiles:

A flashing segment indicates that a number needs to be entered.
 Under submenu „Edit Profile“ enter a profile number.
 Six profiles may be stored (nos. 0 to 5).

Example:

```

Edit
>Edit Profile: 1
Step: 6
Setp: 100.00°C
Time [hh:mm] 01:05
    
```

Edit Profile: Profile No.1

1

Then programme the desired values for each section.
 Use the keypad to set section number, target temperature and time period. Set each entry with enter .

Step: Section No. 6

6

Setpoint: target temperature - 100 °C

1 0 0

Time time period - 1 h:05 minutes

0 1 0 5

When the program is running, only sections having complete information for target temperature and time period are considered. It makes sense, to leave out section numbers in the profile, in order to use them later for corrections in the profile

Important:

If a time of 00:00 is set for a profile, the profile is continued with the next section only after the setpoint temperature (± 0.2 °C) is reached.

Example:

Step	(No.)	1	3	5	6	9	11	14
Setpoint	(°C)	50	50	100	100	80	80	20
Time	(h.m)	00:08	00:02	00:10	01:05	00:10	00:05	00:30

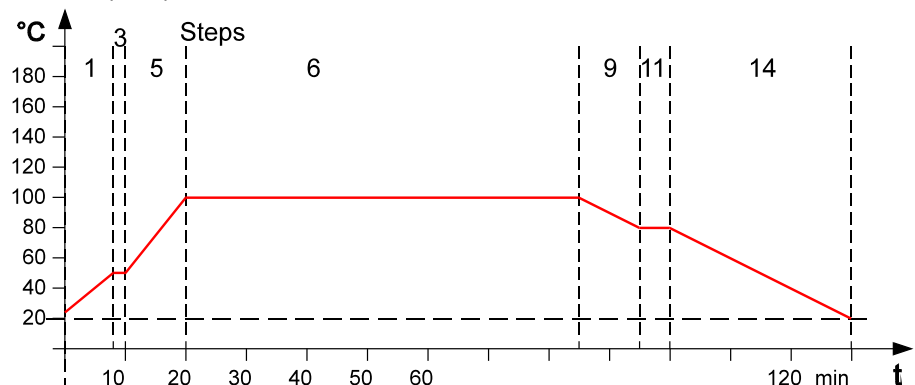

```

Edit
>Edit Profile:    1
Step:            3
Setp:           50.00°C
Time [hh:mm]    00:02
    
```

Display sections (Step):

- 1 Use the keys to select the submenu „Step“, enter the desired number **3** and press enter
 - or
 - 2 If the submenu „Step“ is selected, section by section can be shown in ascending order by the key .
- i** Each previously set value is displayed.

Example:

```

Delete
>Delete Prof.    4
from Step       8
to Step        34
delete          yes
    
```



```

Delete
>Delete Prof.    4
from Step       8
***** delete *****
    
```

Delete:

A flashing segment indicates that the respective profile number needs to be entered in which one or more consecutive sections are to be deleted.

Example:

Delete step 8 to step 34 in profile 4.

```

4  8  3 4   yes 
    
```

Line 4 indicates the deletion.

Example:

```

Print
>Print Profile  2
Print          yes
    
```



```

Print
>Print Profile  2
***** print *****
    
```

Print:

Each profile may be printed via the serial interface for control or documentation.

A flashing segment indicates that the number of the profile to be printed needs to be entered.

Example: Print profile 2

```

2  yes 
    
```

Printing is indicated in line 2.

```

Set Clock
>hour.min      14:24
Day.Mon        07.12
Year           2006
              14:24:36
    
```

Setting clock

The integrated clock allows starting a profile at any date and time. The clock is preset in the factory.

- i** Lines 1 to 3:
Check for correctness of the preset date and time and correct if necessary.

The time is displayed permanently in line 4.

9.5. Analog inputs/outputs

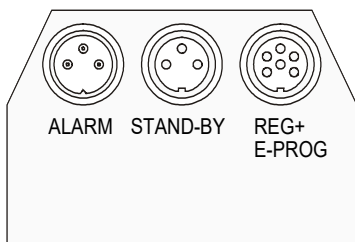

❗ In order to use the analog inputs and outputs, the Cryo-Compact Circulator must be equipped with the electronic module available as option.

Order No. 8 900 100 Electronic module

This submenu enables setting of the input and output values for the programmer input and the temperature recorder outputs of socket REG+E-PROG.





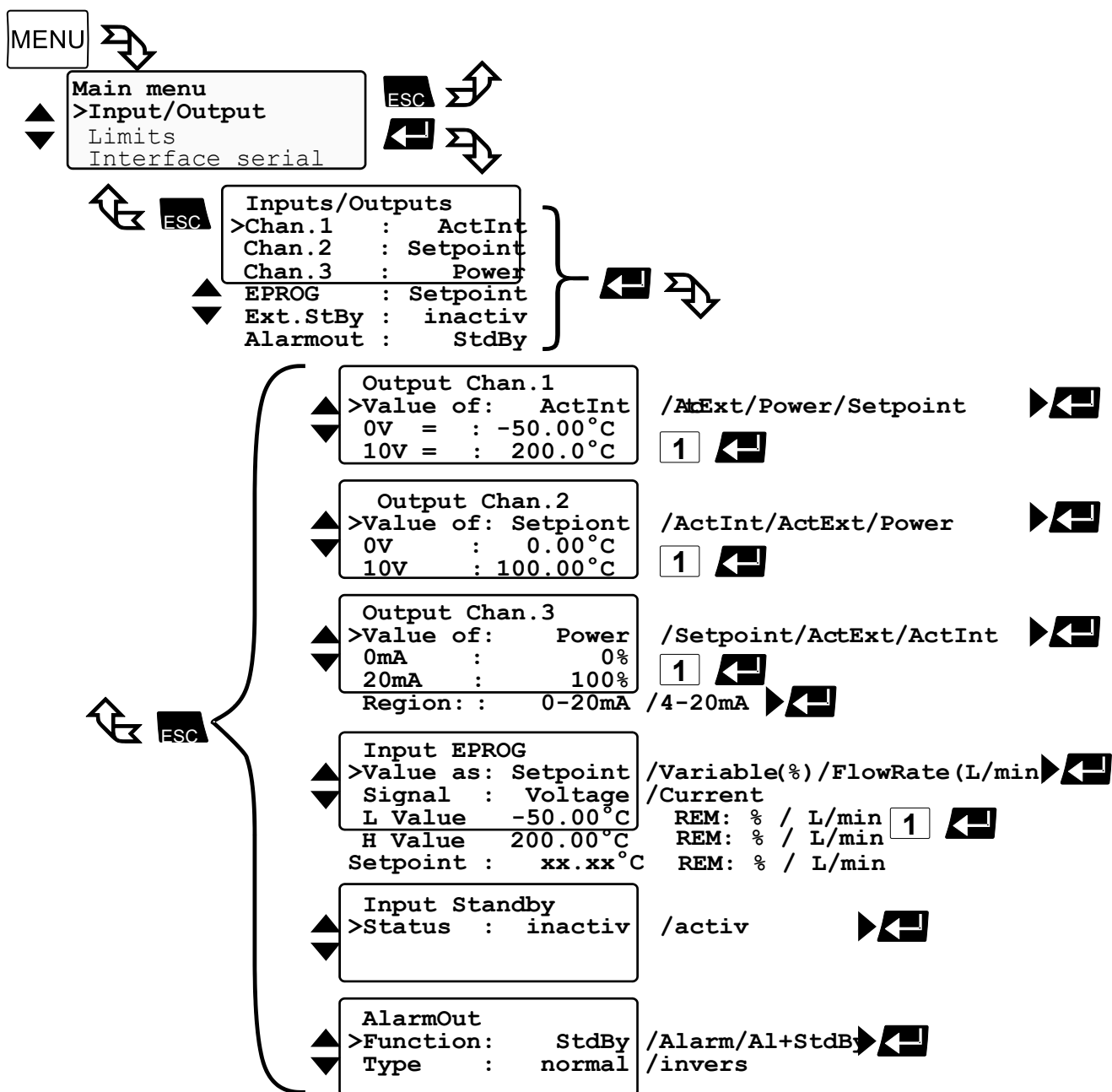





The >STAND-BY< input and the >ALARM< output are configurable.

❗ If the electronic module is not fitted, the item >inputs/outputs< will be missing in the menu.



Menu level 2

Inputs/Outputs	
>Chan.1	: ActInt
Chan.2	: ActInt
Chan.3	: Setpoint
EPROG	: Setpoint
Ext.StBy	: inactiv /activ
AlarmOut	: StdBy

1. Use the keys   to select the desired (>) menu item in menu level 2 on the LCD DIALOG-DISPLAY.
2. Use the keys  and  to store the desired parameter or press enter  to enter menu level 3. An input window opens for each menu item.
3. In the input window in menu level 3 select the menu item with the keys  .
4. Use the keys   to select the parameter (parameter blinks) or use the numeral keypad to enter the numbers (number segment blinks).
5. Press enter  to store the new parameter or value.

Menu level 2

Channel 1	voltage output for recorder (V)
Channel 2	voltage output for recorder (V)
Channel 3	current output for recorder (mA)
EPROG	external programmer input
External standby	Standby input (for external emergency switch-off)
Alarm output	Output for external alarm signal

9.5.1. REG+E-PROG – temperature recorder outputs

REG+E-PROG (11):
Outputs of the connector

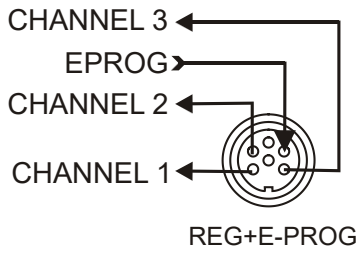

1. First define the desired output value for channels 1 to 3:

ActInt internal actual temperature value (bath temperature)
ActExt external actual temperature value (external sensor)
Power periodic or intermittent heating or cooling
Setpoint active setpoint temperature
 (Setpoint1, 2, 3,/ integr. programmer /external programmer)

2. Then select the display size for channels 1 to 3:

Voltage outputs channels 1 and 2

Assign the voltage values of 0 V to the lowest and 10 V to the highest necessary temperature or power rating required as an output value (°C / %).

Current output channel 3

Assign the current values 0 mA or 4 mA to the lowest and 20 mA to the highest temperature or power rating required as an output value (°C / %).

3. The current output (chanell 3) offers 2 ranges for selection:
 0 to 20 mA or 4 to 20 mA

Examples:

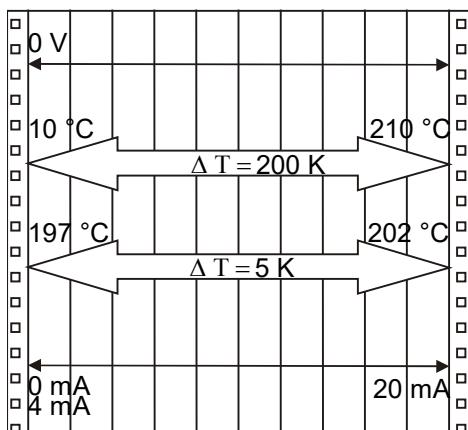

Chan. 1		
>Value of :		ActInt
0V	=	10 °C
10V	=	210 °C

lowest temperature value: 10 °C
 highest temperature value 210 °C
 Fig. shows 200 °C scaled to paper width
 rise: 50 mV/°C

lowest temperature value: 197 °C
 highest temperature value: 202 °C
 Fig. shows 5 °C scaled to paper width
 rise: 2000 mV/°C

9.5.2. REG+E-PROG - programmer input

Menu >Configuration<

```

Configuration
>Setpoint :   eprog   Keypad/RS232/extPt100
Autostart:   off
Standby  :   pump off
Language  :   english
Reset    :       no
Variable :   Control /serial/eprog

```

Menu >Inputs/Outputs<

```

Input EPROG
>Value as:  Flowrate   Setpoint/Variable
Signal   :   Voltage
L Value  :   0.0L      (Liters/Minute)
H Value  :   50.0L
Flowrate:   xx.xL

```

E-PROG - Input

Setting needs to be carried out, if

1. setpoint programming is to be made via an external voltage or current source or programmer
For this, in the menu >Configuration< first set the menu item >Setpoint< to >eprog<.
2. the heater variable should be controlled via an external control pulse.
For this, in the menu >Configuration< set the menu item > Variable.< to >eprog<.
3. the signal of an external flow meter should be registered.

- ① The E-Prog input can only be used either under menu item >**Setpoint**< or under menu item > **Variable** <. If the input is neither occupied by >**Setpoint**< or > **Variable** <, the signal of a flow meter can be connected.

- ① First set menu >Configuration<, then menu >Inputs/Outputs<.

- Connect the external voltage or current source or programmer to socket (12) REG+E-PROG of the circulator.

Selecting the signal:

The programmer (E-PROG) input of the circulator can be matched to the output signal of the external voltage or current source.

Voltage voltage input
Current current input

„L Value“ - Setting the LOW value: (See below ↻)

First adjust and set the lowest voltage or current on the external voltage or current source (e.g. 0 V or 0 mA).

Then after approx. 30 secs enter the corresponding temperature value (e.g. 20.00°C).on the circulator by pressing the appropriate buttons on the keypad and press enter  to set.

„H Value“ - Setting the HIGH value: (See below ↻)

First adjust and set the highest voltage or current on the external voltage or current source (e.g. 10 V or 20 mA).

Then after approx. 30 secs enter the corresponding temperature value (e.g. 300 °C).on the circulator by pressing the appropriate buttons on the keypad and press enter  to set.

Example:

```

Input EPROG
>Value as:  Setpoint
Signal   :   Current
L Value  :   20.0°C
H Value  :   300.0°C
Setpoint:   50.0°C

```

Example:

- Set the external voltage or current source output for the equivalent of 50 °C temperature setpoint.
- The value adjusted and set on the external programmer is displayed in line 4 of the LCD DIALOG-DISPLAY for control purposes.





Menu functions

Eprog	:	50.0 °C
IntAct	:	24.7 °C
Power	:	80 %
Control	:	intern

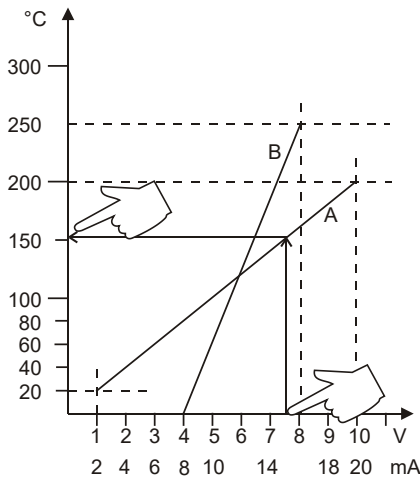
- ❗ After returning the LCD display to standard display by pressing  the temperature value adjusted and set on the external voltage or current source is displayed in line 1 (Example: Eprog : 50.00 °C).

This EPROG input enables the use of different voltage and current values as program parameters.



- **L Value“ - Setting the LOW value:** (See below )
 - 1) Adjust and set the lowest desired value on the voltage or current source resp. (Example A: 1 V). Wait appr. 30 seconds.
 - 2) Assign a lower temperature threshold value to this adjusted voltage/current value by pressing the appropriate buttons on the keypad of the instrument (Example A: 20 °C) and set by pressing enter .
- **„H Value“ - Setting the HIGH value:** (See below )
 - 1) Adjust and set the highest desired value on the voltage or current source resp. (Example A: 10 V). Wait appr. 30 seconds.
 - 2) Assign an upper temperature threshold value to this adjusted voltage/current value by pressing the appropriate buttons on the keypad of the instrument (Example A: 200 °C) and set by pressing enter .
- Return to the standard display by pressing .

- ❗ Example B in the diagram serves to illustrate that the end point values are freely selectable (Ex: 8 mA and 16 mA).

Input EPROG	
>Value as:	Setpoint
Signal :	Voltage
L Value :	20.0 °C
H Value :	200.0 °C
Setpoint:	152.0 °C

Example out of diagram A:

- Adjusting the voltage source for an output of 7.6 V!

Line 5 of the LCD DIALOG-DISPLAY shows the externally set setpoint value. The instrument calculates this value from the rise angle of the two pre-decided end points (in example A: 7.6 V correspond to an external setpoint temperature of 152.0 °C).



Eprog	:	152.00 °C
IntAct	:	50.76 °C
Power	:	100 %
Control	:	intern

After returning the LCD display to standard display by pressing , this value is displayed in line 1 (Example: EPROG 152.00 °C).



Notice:

If this adjustment is not correctly performed at two different points, the setpoint setting will be incorrect.



Important:

The usable temperature range between > **L Value** < and > **H Value** < is limited to the configured working temperature range of the Cryo-Compact Circulator resp. of the unit combination (working temperature range see technical specifications on page 8)

9.5.3. STAND-BY input

Ext. StBy (10)

(for external emergency switch-off)

(Connector see page 68)

Possible parameters:

inactiv - standby input is ignored

activ - standby input is active

Activate the standby input:

1. Under menu item **>Ext. StBy<**, set the parameter to **>activ<**.
2. Connect an external contact ,AK' (e.g. for emergency switch-off) or an alarm contact of the superordinated system.

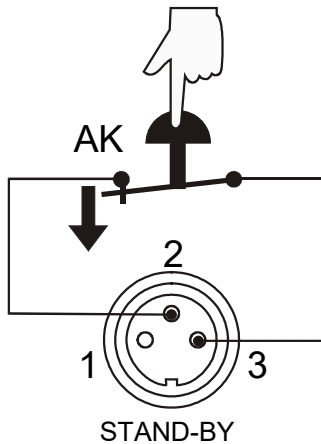

In case the connection between Pin 2 and Pin 3 is interrupted by opening the contact ,AK', a complete shutdown of the circulating pump and heater is effected, and the unit enters the condition „E OFF“.

As long as the contact remains open, line 4 of the LCD DIALOG-DISPLAY flashes and displays the message „STAND-BY“.

If the contact is reclosed, the instrument returns to the standby state and „E OFF „ is displayed. Press  to start.

```
Setpoint1: 150.00°C
IntAct   : xxx.xx°C
Power    : xx %
STAND-BY
```

```
E OFF
S xx.xx
E -----
```

ⓘ Additional tips for using the STANDBY input:

The standby function can be used in conjunction with the AUTOSTART feature (see page 34).

1. If the Autostart function is NOT turned ON, the standby input is used as described above.
2. If the Autostart function is enabled, the instrument will revert back to the original method of entering the setpoint (i.e. keypad, RS232, Analog input, etc.).

- Entering the setpoint with the keypad. e.g. 

As described above, a bipolar shut-down is accompanied by the „STAND-BY“ display and the OFF state. The programmable controller starts again when the contact is reclosed. The temperature of the bath fluid changed during the STAND-BY state.

- Entering the setpoint with the programmer (see pages 45). The display „STAND-BY“ appears. The setpoint value and the time are both held at the current value. The temperature of the bath fluid will be held constant at this temperature. The programmer continues once the contact is reclosed.

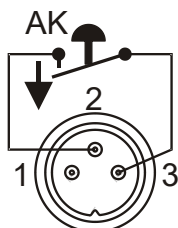

```
Setpoint : xxx.xx°C
IntAct   : xxx.xx°C
Profil    : 4 Step:12
*** STAND-BY ***
```

⚠ Notice: this is not an actual shutoff feature.

9.5.4. ALARM output

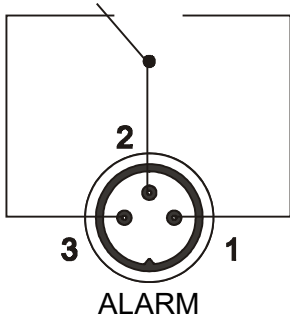

Alarm output (9)

(for external alarm signal)

This socket is a potential-free change-over contact. With the adjustments in the menu >Inputs/Outputs< all operating conditions can be signaled without having to change the pin assignments.

Menu >Inputs/Outputs<

```

AlarmOut
>Function:      StdBy /Alarm/Al+StBy
Type           :      normal /invers
    
```

Signification of the terms under menu item >Function< :

The Cryo-Compact Circulator is in condition

>StandBy< or >Alarm<

```

- OFF -
S xx.xx
E -----
    
```

```

XXXXXX
ALARM
CODE xx
    
```

For >Type: normal< pins 2 and 3 are connected in any case according to the selected >Function<.

For >Type: invers< pins 2 and 1 are connected in any case according to the selected >Function<.

- Switching capacity max. 30 W / 40 VA
- Switching voltage max. 125 V~/-
- Switching current max. 1 A

9.6. Limits

The menu >Limits< allows for setting the minimum and maximum values for all important setting ranges and capacity variables.

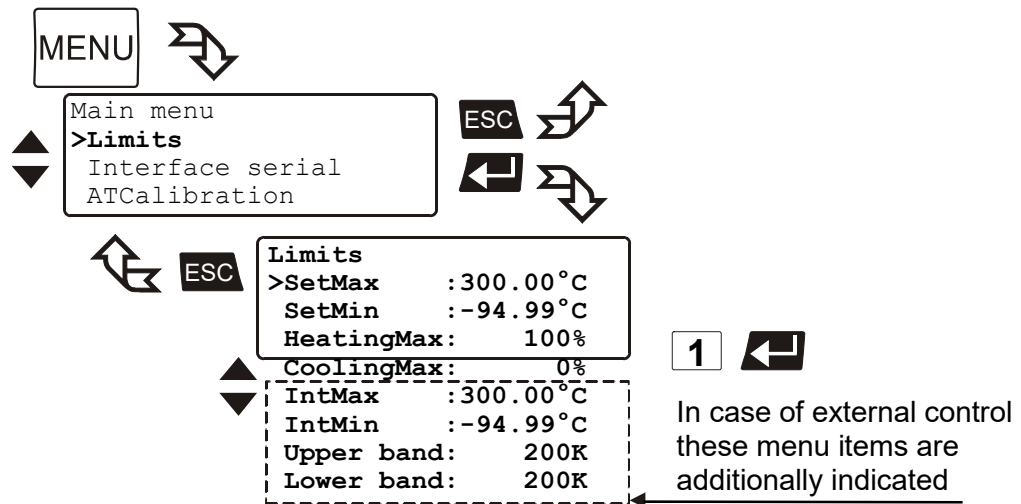

SetMax: and **SetMin:** Maximum and minimum setpoint

Restriction for the adjustable temperature range.

Setting range: see working temperature range

The limitation of the operating temperature range effects the temperature

setting under the menu called up with the **T** key - Setpoint 1, 2, 3.

It is possible to adjust only working temperatures that lie within the limit range set here.

Existing settings for Setpoint 1, 2, 3 and also for >OverTemp< and >SubTemp< (see page 28) are automatically deferred within the limit range.

HeatingMax: and **CoolingMax:**

Adjusted maximum heating / cooling.

Setting range: 0 to 100 % in steps of 1 %

Heating and cooling powers of the Cryo-Compact Circulator are adjustable. 100 % corresponds to the values in the technical specifications of the equipment.

Factory setting: **CoolingMax**

CF31 100 % (fixed value)

CF41 0 to 100 % in steps of 1 %

IntMax: and **IntMin:** Limit setting

Setting range: see working temperature range page 8

The limits IntMax and IntMin are only valid for external control. IntMax and IntMin are used to limit the expected internal bath temperatures to any upper and lower values. The temperature controller cannot exceed these limits even if it would be required for reaching the temperature in the external system. Consequently the external setpoint may thus not be reached.

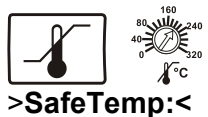

Sense of a limit setting:

- Protects the bath fluid from overheating.
- Prevents an undesired alarm shut-down by the excess temperature protection - >ALARM CODE 14<. Set >IntMax:< to a value at least 5 °C below the >SafeTemp:< value.
- Protects the pump motor from high viscosity of the bath fluid at low temperatures.
- For refrigerated Cryo-Compact Circulator s: Freezing protection when using water as bath fluid.

Upper band: and **Lower band:** Band limit

The band limit is active for external control.

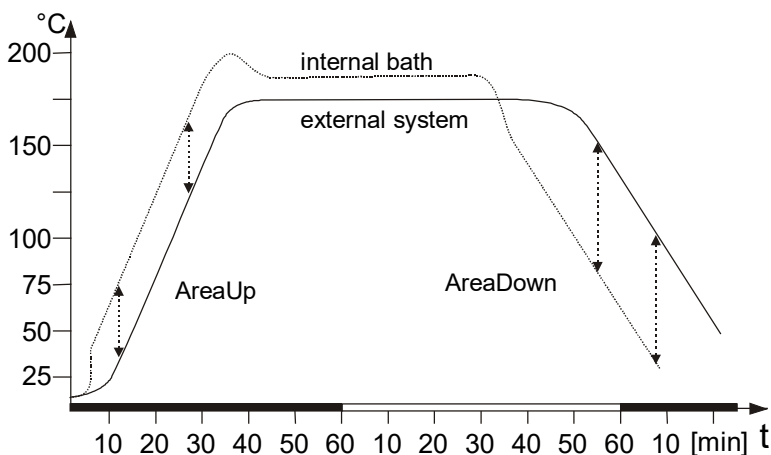

For the heat-up and cool-down phases different settings to conform to the requirements of the particular application are possible.

Setting range: 0 ... 200 °C

Using Upper band and Lower band, the difference between the temperatures in the internal bath and the external system can be limited to any maximum value for the heat-up or the cool-down phase.

During the heat-up phase the difference value always adds to the actual external temperature. During the cool-down phase, the difference value is subtracted.

Sense of a band limit:

- Ensures gentle heating for the objects requiring temperature application.
- Protects glass reactors, for example, from thermal shock.

i The **IntMax:** and **IntMin:** values are superordinated to this band limit.

9.7. Serial interface

For communication between Cryo-Compact Circulator and a PC or a superordinated process system the interface parameters of bath units must be identical. The adjustment is usually carried out one time only in the menu >Interface serial<.

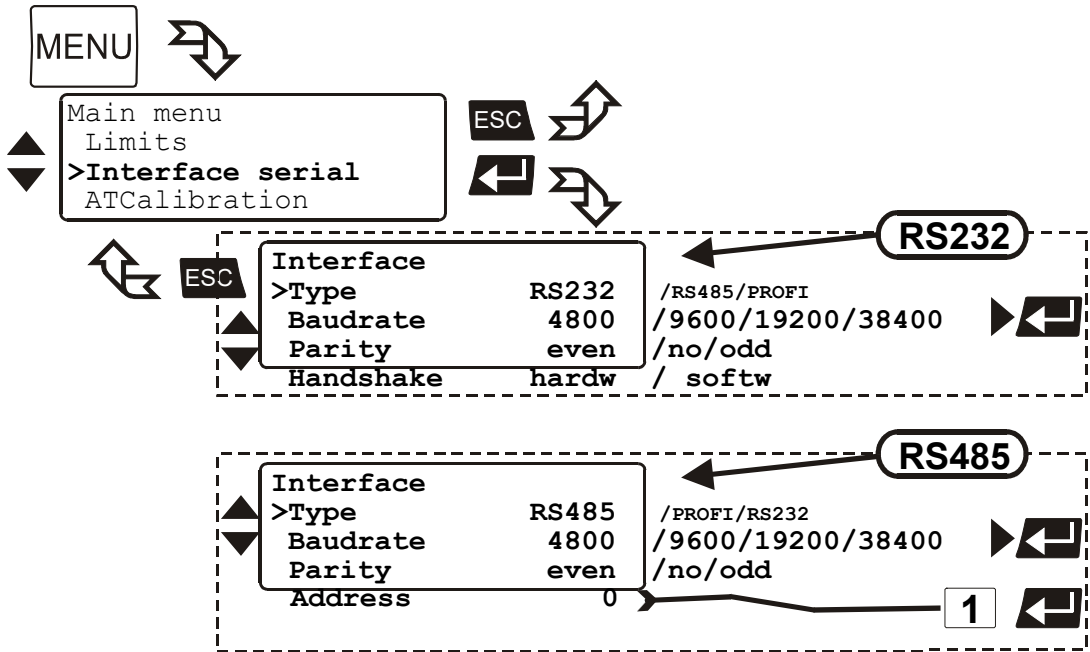

- Type** RS232 / RS485
- Baud rate** 4800/9600/19200/38400
- Parity** none/even/odd
- Handshake** software handshake/hardware handshake

Address 0 to 127

Factory settings:
 4800 Bauds
 even
 hardware handshake

9.8. ATC Absolute Temperature Calibration, 3-point calibration

ATC serves to compensate a temperature difference that might occur between Cryo-Compact Circulator and a defined measuring point in the bath tank because of physical properties.

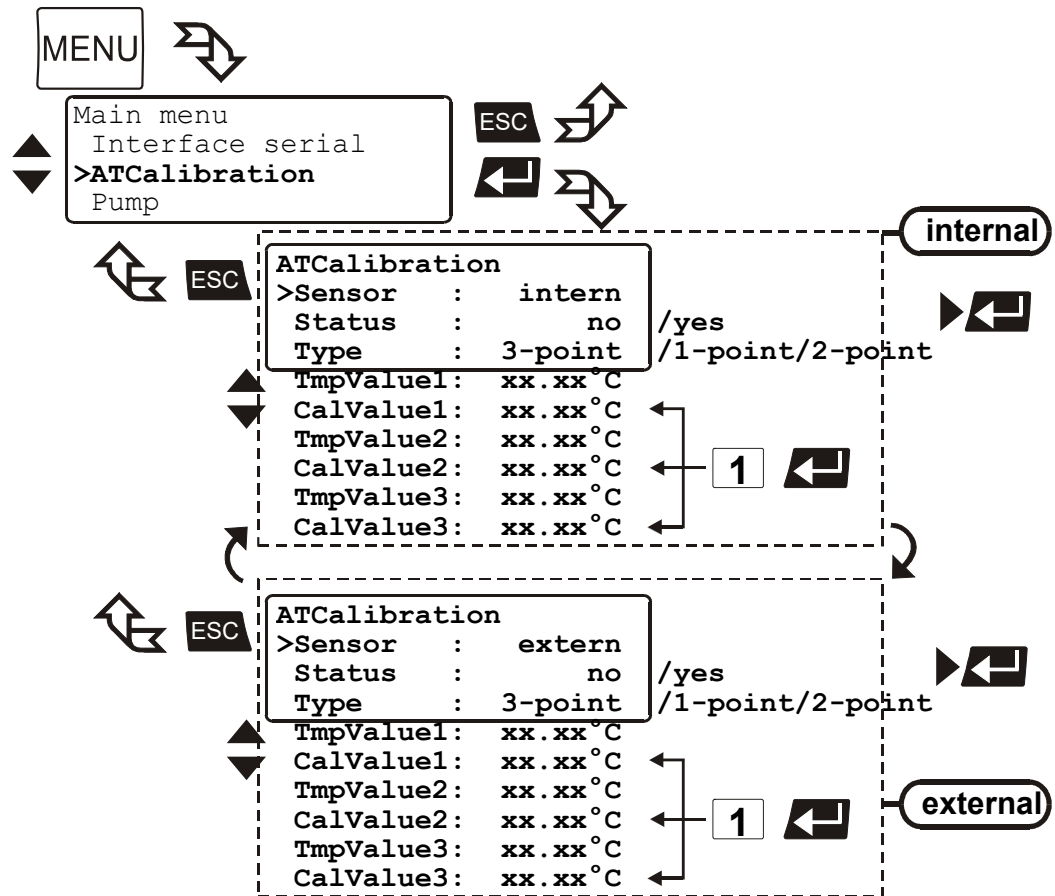

Sensor: >intern<, >extern<

Calibration can be carried out for the internal temperature sensor and for the external temperature sensor connected to the socket „ext. Pt100“.

The Cryo-Compact Circulator is able to store both parameter sets. However, only the one set under this menu item is indicated.

Status:

>no< The controller of the Cryo-Compact Circulator uses the original curve of the temperature sensor.

Important: During the calibration process **>no<** needs to be set.

>yes< The controller of the Cryo-Compact Circulator uses the new calibration curve.

Type:

A >1-point<, >2-point < or >3-point < calibration can be carried out.

First geometrically define the location for calibration (measuring point T_M), then determine the temperature values of the calibration points.

The calibration type also determines the number of pairs of values indicated on the LCD DIALOG-DISPLAY.

TmpValue: 1 or 2 or 3

Defined temperature value of the calibration point. This value is automatically stored with >CalValue< and can be indicated for control purposes.

CalValue: 1 or 2 or 3

The „Calibration value“ is determined with a temperature measuring device and stored under menu item >CalValue<.

Example:

1-point calibration

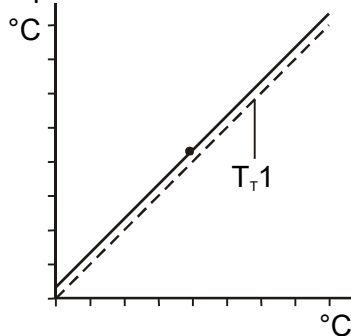

3-point calibration

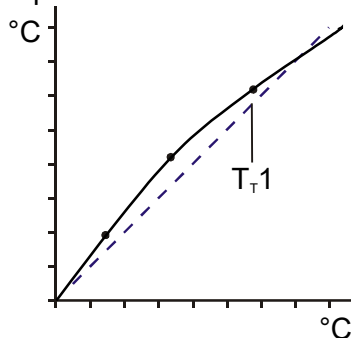

$T_T 1$ = Original curve

Principle:

For ATC calibration, in steady state the bath temperature at the location of the temperature sensor (T_M) is determined at the respective adjusted working temperature. This value is then set on the Cryo-Compact Circulator in the menu >ATCalibration< under menu item >Calvalue X<. This can be a 1-point, 2-point or 3-point calibration.

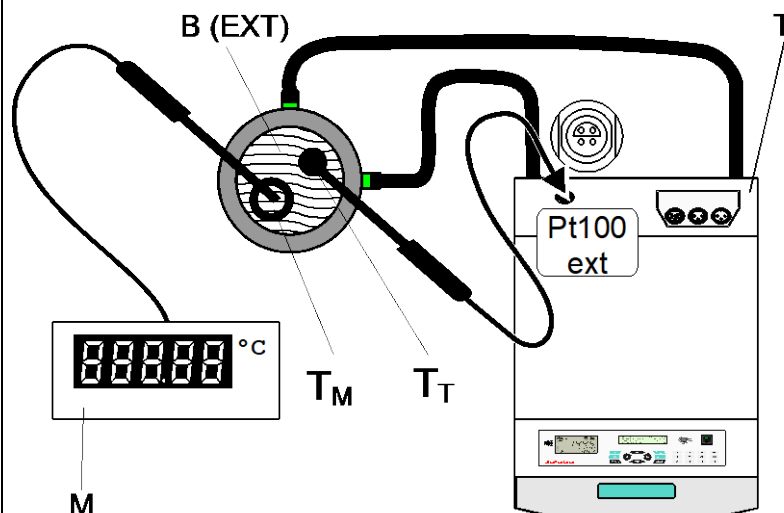

M = Temperature measuring instrument with temperature sensor

B = Bath tank (internal or external)

T = Cryo-Compact Circulator

T_M = Temperature on measuring point

T_T = Temperature on Cryo-Compact Circulator

1. Use the keys to select the menu item.
2. With the keys select the parameter (parameter blinks) or use the numeral keypad to enter the numbers (number segment blinks).
3. Press enter to store the new parameter or value.

Menu functions

Examples:

$T_T = 80.00\text{ }^\circ\text{C}$
 $T_M = 79.73\text{ }^\circ\text{C}$
 $T_T = 120.00\text{ }^\circ\text{C}$
 $T_M = 119.51\text{ }^\circ\text{C}$
 $T_T = 160.00\text{ }^\circ\text{C}$
 $T_M = 159.34\text{ }^\circ\text{C}$

```
Control
>ControlType: intern
Selftuning:  once
Dynamic :  aperio
```



```
Setpoints
>Setpoint1:  80.00°C
Setpoint2:  37.00°C
Setpoint3:  70.00°C
```

```
ATCalibration
>Sensor :  intern
Status  :  no
Type    :  3.point
TmpValue1: 80.00°C
CalValue1: 79.73°C
TmpValue2: xx.xx°C
CalValue2: xx.xx°C
TmpValue3: xx.xx°C
CalValue3: xx.xx°C
```

Example:



3-point calibration for internal control.

In the temperature range of 80 °C to 160 °C the calibration curve of the temperature sensor (T_T) should be assimilated to the actual temperatures on the measuring point (T_M).

- Press the  button. Under the menu >Control< set >ControlType< to >intern< and press enter .
- Press start/stop .

(**ControlType**: Can only be adjusted in the **-OFF-** condition)

Calibration procedure:

1. Press  and set the first temperature value under >Setpoint1< for example (example 1st value = 80 °C).
2. Wait until this temperature is maintained constant in the bath for about 5 minutes.
3. Press the  button and open the menu >ATCalibration<.
4. Set the following:
Menu item >Sensor< to >intern< ,
Menu item >Status< to >no< ,
Menu item >Type< to >3-point<.
5. Read the value of T_M on the temperature measuring device and enter the value under menu item >CalValue 1< (79.73 °C) using the numeral keypad.
Press enter  and the Cryo-Compact Circulator also stores the value of T_T as value for >TmpValue 1< (80.00 °C) .
The first of the 3 points is now calibrated.
6. Repeat the calibration procedure for 120 °C and 160 °C.

9.9. Setting the pump pressure

Examples:

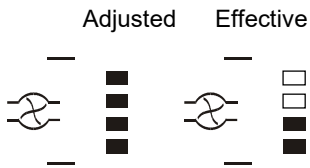

The pressure of the circulating pump is adjustable in four grades. After setting, the VFD-Info-Display indicates the corresponding value.

Adjustable pump capacity stage 1 ... 4

Illuminated display:  for pump pressure

 Display for the adjusted pump pressure stage in the –OFF- mode.





 Display for the effective pump pressure stage (rotation speed) after start.

For protecting the pump motor, the rotation speed changes with the load applied, for example depending on the viscosity of the bath fluid at different working temperatures.

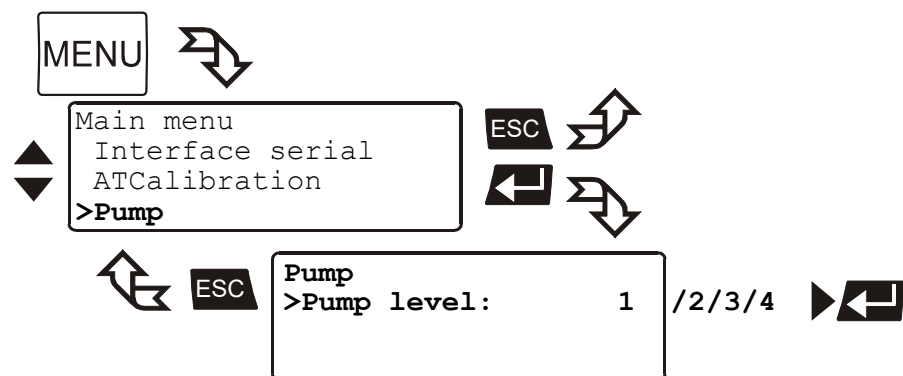
Flow rate: 22 ... 26 l/min

Pump capacity stage		1	2	3	4
Pump pressure:	[bar]	0,4	0,5	0,6	0,7
Suction pump	[bar]	0,2	0,26	0,33	0,4
Total capacity in a loop circuit	[bar]	0,6	0,76	0,93	1,1



1. Use the keys   to select the menu item.
2. With the keys   select the parameter (parameter blinks).
3. Press enter  to store the new parameter or value.

10. Troubleshooting guide / Error messages

XXXXXX
ALARM
CODE 01



XXXXXX
WARNING
CODE 40

Alarm with a complete shutdown of the unit

Whenever the microprocessor electronics registers a failure, a complete shutdown of the compressor, heater and circulating pump is performed.

The alarm light „“ illuminates and a continuous signal tone sounds. The VFD-COMFORT-DISPLAY indicates the cause for the alarm in form of a code.

Warning without a complete shutdown of the unit

The VFD-COMFORT-DISPLAY indicates the cause for the warning in form of a code and an acoustic signal sounds in regular intervals.

These messages appear every 10 seconds.



Press enter  to quit the audible signal.

Press **F** to indicate the help text in the LCD DIALOG-DISPLAY when alarm messages appear.

ALARM

CODE 01 **F** 

Insufficient liquid level or float is defective.

- The Cryo-Compact Circulator is operated without bath fluid, or the liquid level is insufficient. Replenish the bath tank with the bath fluid.
- Tube breakage has occurred (insufficient filling level due to excessive bath fluid pumped out). Replace the tubing and replenish the bath tank with the bath fluid.
- The float is defect (e. g., because damaged in transit). Repair by authorized JULABO service personnel.
-

WARNING

CODE 03 **F** 

Actual temperature above high temperature value.

ALARM

CODE 03 **F** 

Actual temperature above high temperature value.

- Excess temperature warning or Excess temperature alarm

Warn-Type: Set to >Warning< or >Alarm<

WARNING

CODE 04 **F** 

Actual temperature below low temperature value.

ALARM

CODE 04 **F** 

Actual temperature below low temperature value.

- Low temperature warning or Low temperature alarm.

Warn-Type: Set to >Warning< or >Alarm<

ALARM

CODE 05 **F** 

Internal working sensor short-circuited or interrupted.

- Cable of the working temperature sensor interrupted or short-circuited.

ALARM**CODE 06** **F** ↗

Difference between working- and safety-temp. Bigger than permissible value.

- Defect of the working or excess temperature sensor. Working temperature and excess temperature sensors report a temperature difference of more than 35 K.

ALARM**CODE 07** **F** ↗

The internal I2C bus-system shows a failure.

- Other errors (I²C-BUS errors)

ALARM**CODE 12** **F** ↗

Error in A/D-converter of the internal measuring system.

- Error in A/D converter

ALARM**CODE 14** **F** ↗

Working temperature exceeds the adjusted safety temperature.

- Excess temperature sensors defect.
- The excess temperature value lies below the working temperature setpoint. Set the excess temperature to a higher value.

ALARM**CODE 15** **F** ↗

External control selected, but ext. sensor not connected or defective.

- External control selected, but external Pt100 sensor not connected or defect.

WARNING**CODE 20** **F** ↗

Cooling is affected or ambient temperature to high
Clean condenser

- Cooling of the condenser is affected. Clean air-cooled condenser. Check the flow rate and cooling water temperature on water-cooled condenser.

WARNING**CODE 21** **F** ↗

Compressor does not work. Compressor will be automatically reconnected.

- Compressor does not work. After a short cooling interval, the compressor motor will be automatically reconnected and the message "CODE 21" no longer appears.

ALARM**CODE 33** **F** ↗

Internal safety-temperature sensor short-circuited or interrupted.

- Cable of the excess temperature sensor interrupted or short-circuited

ALARM

CODE 38 **F** ↻

Ext. Sensor input without signal but setpoint programming set to ext. Pt100.

- Ext. Pt100 sensor input without signal, but setpoint programming set to external Pt100.

WARNING

CODE 40 **F** ↻

Niveau level warning
Critical fluid level
Replenish the bath tank with bath fluid

- The early warning system for low level signals a critical fluid level. Replenish the bath tank with the bath fluid.



Cancel the alarm state.

Press the mains power switch off. After eliminating the malfunction, press the mains power on again to cancel the alarm state. If the unit cannot be returned to operation, contact an authorized service station.

Disturbances that are not indicated.

The electronic pump motor is overload-protected by an electronic current limiter. If viscosity of the bath fluid is or becomes too high, the motor stops running.

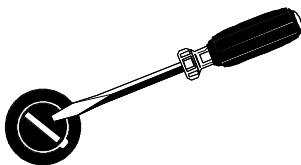

Mains fuses:

The mains fuses on the rear of the unit may easily be exchanged as shown on the left.

- Fine fuses: T 16 A, 250 V~ , D5 x 20 mm
 T 20 A (CF41 115 V / 60 Hz)

Fehler! Es ist nicht möglich, durch die Bearbeitung von Feldfunktionen Objekte zu erstellen.

Warning: Before exchanging the fuses, turn off the mains power switch and disconnect the power plug from the mains socket!
Only use fine fuses with a nominal value as specified.

Example:

Manufacturer	Supplier	Type	Order No.
Schurter	Schurter	G-fuse insert SPT T16A 5x20mm	No. 0001.2516

11. Electrical connections



Notice:

Use shielded cables only.
The shield of the connecting cable is electrically connected to the plug housing.
The unit ensures safe operation if connecting cables with a maximum length of 3 m are used. The use of longer cables does not affect proper performance of the unit, however external interferences may have a negative impact on safe operation.



RS232/RS485 serial interface

This port can be used to connect a computer with an RS232 or RS485 cable for remote control of the Cryo-Compact Circulator.

Pin assignments RS232:

Pin 2	RxD	Receive Data
Pin 3	TxD	Transmit Data
Pin 5	0 V	Signal GND
Pin 7	RTS	Request to send
Pin 8	CTS	Clear to send

Pin 1; 4, 6; 9 Reserved - do not use!

Pin assignments RS485:

Pin 3	B	
Pin 5	0 V	Signal GND
Pin 6	+5 V (50 mA max. load current)	
Pin 8	A	

Pins 1; 2; 7; 9 are reserved - do not use!



Notice: RS485 serial interface

The max. load current between Pin 5 and Pin 6 is 50 mA.

Accessories:

Order No.	Description
8 980 073	RS232 interface cable 9-pol./9-pol. , 2,5 m
8 900 110	USB interface adapter cable

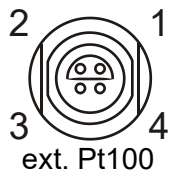

Socket for external Pt100 sensor

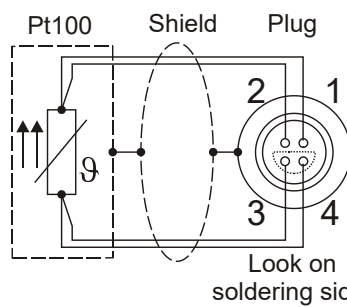

Pin assignment:

Pin	Signal
1	I+
2	U+
3	U-
4	I-

The shield of the connecting cable is electrically connected to the plug housing and the sensor tube.

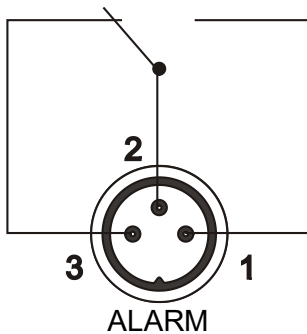

Alarm output

(for external alarm signal)

This potential-free change-over contact is activated in case of an alarm when pins 2 and 3 are connected.

Switching capacity	max.	30 W / 40 VA
Switching voltage	max.	125 V~/–
Switching current	max.	1 A

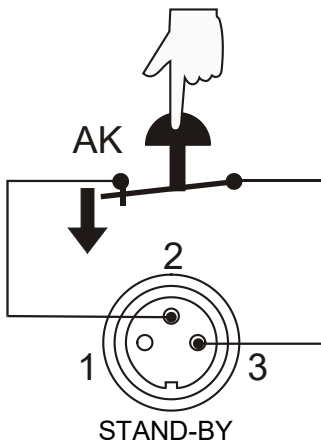

STAND-BY input

(for external emergency switch-off)

Pin assignment:

Pin	Signal
1	not connected
2	5 V / DC
3	0 V

Functional description see page 55

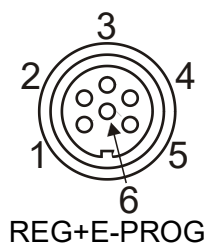

Programmer input / temperature recorder output

Pin	Signal
1 Voltage output	Channel 1 0 ... 10 V
2 Voltage output	Channel 2 0 ... 10 V
3 GND for outputs	0 V
4 Programmer input	EPROG 0 to 10 V / 0 to 20 mA
5 Current output	Channel 3 0 to 20 mA / 4 to 20 mA
6 GND for Programmer	0 V

Functional description see page 52

12. Remote control

12.1. Setup for remote control

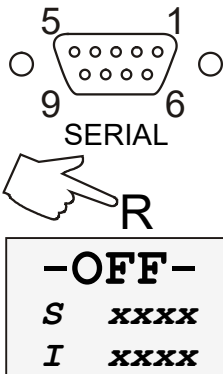

1. Check the interface parameters for both interfaces (on Cryo-Compact Circulator and PC) and make sure they match.
In the menu >Interface< set the menu item >Type< to >RS232< or >RS485<.(Serial interface see page 59)
2. In the menu >Configuration< set the menu item >Setpoint< to >RS232< or >RS485<.
(>Configuration< see page 33)
3. Connect both units with an interface cable..



Like all parameters which can be entered through the keypad, interface parameters are stored in memory even after the Cryo-Compact Circulator is turned off.

12.2. Communication with a PC or a superordinated data system

If the Cryo-Compact Circulator is put into remote control mode via the configuration level, the VFD COMFORT-DISPLAY will read „R -OFF-„ = REMOTE STOP. The Cryo-Compact Circulator is now operated via the computer.
In general, the computer (master) sends commands to the Cryo-Compact Circulator (slave). The Cryo-Compact Circulator sends data (including error messages) only when the computer sends a query.



In remote control mode: After a power interruption the order to start and all values which have to be adjusted must be resent from the personal computer via the interface.
AUTOSTART is not possible.

A transfer sequence consists of:

- address (RS485 interface only)
- command
- space (↔; Hex: 20)
- parameter (the character separating decimals in a group is the period)
- end of file (↵; Hex: 0D)
- The response (data string) after an **in** command is always followed by a line feed (LF, Hex: 0A).

Important times for a command transmission:

To ensure a safe data transfer, the time gap between two commands should be at least 250 ms.

The Cryo-Compact Circulator automatically responds to an **in** command with a data string followed by a LF (Line Feed). The next command should only be sent after 10 ms.



The commands are divided into **IN** or **OUT** commands.

IN commands: asking for parameters to be displayed

OUT commands: setting parameters



The **out** commands are valid only in remote control mode.

Examples:

When the RS485 interface is used, the three-digit instrument address stands in front of each command.

(example: address Ad32 = **A032**)

Command to set the working temperature >Setpoint1< to 55.5 °C

OUT_SP_00 ↔ **55.5**↵

A032_OUT_SP_00 ↔ **55.5**↵

Command to ask for the working temperature >Setpoint1<

IN_SP_00↵

A032_IN_SP_00↵

Response from the Cryo-Compact Circulator :

55.5↵ LF

A032_55.5↵ LF



Notice: **OUT-commands**

Temperature values can be displayed on the Cryo-Compact Circulator in °C or °F. The settings sent via the interface must also be made in the selected unit according to this setting.

12.3. List of commands

OUT commands: Setting parameters or temperature values.

Command	Parameter	Response of Cryo-Compact Circulator
OUT_MODE_01	0	Use working temperature >Setpoint1<
OUT_MODE_01	1	Use working temperature >Setpoint2<
OUT_MODE_01	2	Use working temperature >Setpoint3<
OUT_MODE_02	0	Selftuning „off“. Temperature control by using the stored parameters.
OUT_MODE_02	1	Selftuning „once“ Single selftuning of controlled system after the next start.
OUT_MODE_02	2	Selftuning „always“ Continual selftuning of controlled system whenever a new setpoint is to be reached.

Command	Parameter	Response of Cryo-Compact Circulator
OUT_MODE_03	0	Set external programmer input to voltage. Voltage 0 V ... 10 V
OUT_MODE_03	1	Set external programmer input to current. Current 0 mA ... 20 mA
OUT_MODE_04	0	Temperature control of internal bath.
OUT_MODE_04	1	External control with Pt100 sensor.
OUT_MODE_05	0	Stop the unit = R -OFF-.
OUT_MODE_05	1	Start the unit.
OUT_MODE_08	0	Set the control dynamics - aperiodic
OUT_MODE_08	1	Set the control dynamics - standard
OUT_SP_00	xxx.xx	Set working temperature. „Setpoint 1“
OUT_SP_01	xxx.xx	Set working temperature. „Setpoint 2“
OUT_SP_02	xxx.xx	Set working temperature. „Setpoint 3“
OUT_SP_03	xxx.xx	Set high temperature warning limit „OverTemp“
OUT_SP_04	xxx.xx	Set low temperature warning limit „SubTemp“
OUT_SP_06	xxx.xx	Set manipulated variable for the heater via serial interface -100 ... +100 [%]
OUT_SP_07	x	Set the pump pressure stage. (1 ... 4)
OUT_PAR_04	x.x	CoSpeed for external control 0 ... 5.0
OUT_PAR_06	xxx	Xp control parameter of the internal controller. 0.1 ... 99.9
OUT_PAR_07	xxx	Tn control parameter of the internal controller. 3 ... 9999
OUT_PAR_08	xxx	Tv control parameter of the internal controller. 0 ... 999
OUT_PAR_09	xxx	Xp control parameter of the cascade controller. 0.1 ... 99.9
OUT_PAR_10	xxx	Proportional portion of the cascade controller. 1 ... 99.9
OUT_PAR_11	xxx	Tn control parameter of the cascade controller. 3 ... 9999
OUT_PAR_12	xxx	Tv control parameter of the cascade controller. 0 ... 999
OUT_PAR_13	xxx	Maximum internal temperature of the cascade controller.
OUT_PAR_14	xxx	Minimum internal temperature of the cascade controller.
OUT_PAR_15	xxx	Band limit (upper) 0 ... 200 °C
OUT_PAR_16	xxx	Band limit (lower) 0 ... 200 °C
OUT_HIL_00	-xxx	Set the desired maximum cooling power (0 % to 100 %). Note: Enter the value with a preceding negative sign! This command only valid with the CF41.
OUT_HIL_01	xxx	Set the desired maximum heating power (10 % to 100 %).

IN commands: Asking for parameters or temperature values to be displayed.

Command	Parameter	Response of Cryo-Compact Circulator
VERSION	None	Number of software version (V X.xx)
STATUS	none	Status message, error message (see page 73)
IN_PV_00	none	Actual bath temperature.
IN_PV_01	none	Heating power being used (%).
IN_PV_02	none	Temperature value registered by the external Pt100 sensor.
IN_PV_03	none	Temperature value registered by the safety sensor.
IN_PV_04	none	Setpoint temperature („SafeTemp“) of the excess temperature protection
IN_SP_00	none	Working temperature „Setpoint 1“
IN_SP_01	none	Working temperature „Setpoint 2“
IN_SP_02	none	Working temperature „Setpoint 3“
IN_SP_03	none	High temperature warning limit „OverTemp“
IN_SP_04	none	Low temperature warning limit „SubTemp“
IN_SP_05	none	Setpoint temperature of the external programmer (REG+E-PROG) .
IN_SP_06	none	Temperature indicatio in °C or °F
IN_SP_07	none	1. Adjusted pump stage in the -OFF- condition. 2. Pump stage corresponding to the effective rotation speed after start.
IN_SP_08	none	Value of a flowrate sensor connected to the E-Prog input
IN_PAR_00	none	Temperature difference between working sensor and safety sensor
IN_PAR_01	none	Te - Time constant of the external bath.
IN_PAR_02	none	Si - Internal slope
IN_PAR_03	none	Ti - Time constant of the internal bath.
IN_PAR_04	none	CoSpeed - Band limit (max. difference between the temperatures in the internal bath and external system).
IN_PAR_05	none	Factor pk/ph0: Ratio of max. cooling capacity versus max. heating capacity
IN_PAR_06	none	Xp control parameter of the internal controller.
IN_PAR_07	none	Tn control parameter of the internal controller.
IN_PAR_08	none	Tv control parameter of the internal controller.
IN_PAR_09	none	Xp control parameter of the cascade controller.
IN_PAR_10	none	Proportional portion of the cascade controller.

Command	Parameter	Response of Cryo-Compact Circulator
IN_PAR_11	none	Tn control parameter of the cascade controller.
IN_PAR_12	none	Tv control parameter of the cascade controller.
IN_PAR_13	none	Adjusted maximum internal temperature of the cascade controller.
IN_PAR_14	none	Adjusted minimum internal temperature of the cascade controller.
IN_PAR_15	none	Band limit (upper)
IN_PAR_16	none	Band limit (lower)
IN_MODE_01	none	Selected setpoint: 0 = Setpoint 1 1 = Setpoint 2 2 = Setpoint 3
IN_MODE_02	none	Selftuning type: 0 = Selftuning „off“ 1 = Selftuning „once“ 2 = Selftuning „always“
IN_MODE_03	none	Type of the external programmer input: 0 = Voltage 0 V to 10 V 1 = Current 0 mA to 20 mA
IN_MODE_04	none	Internal/external temperature control: 0 = Temperature control with internal sensor. 1 = Temperature control with external Pt100 sensor.
IN_MODE_05	none	Cryo-Compact Circulator in Stop/Start condition: 0 = Stop 1 = Start
IN_MODE_08	none	Adjusted control dynamics 0 = aperiodic 1 = standard
IN_HIL_00	none	Max. cooling power (%).
IN_HIL_01	none	Max. heating power (%).

12.4. Status messages

Status messages	Description
00 MANUAL STOP	Cryo-Compact Circulator in „OFF“ state.
01 MANUAL START	Cryo-Compact Circulator in keypad control mode.
02 REMOTE STOP	Cryo-Compact Circulator in „r OFF“ state.
03 REMOTE START	Cryo-Compact Circulator in remote control mode.

12.5. Error messages

Error messages	Description
-01 LOW LEVEL ALARM	Low liquid level alarm
-03 EXCESS TEMPERATURE WARNING	High temperature warning
-04 LOW TEMPERATURE WARNING	Low temperature warning.
-05 WORKING SENSOR ALARM	Working temperature sensor short-circuited or interrupted.
-06 SENSOR DIFFERENCE ALARM	Sensor difference alarm. Working temperature and safety sensors report a temperature difference of more than 35 K.
-07 I²C-BUS ERROR	Internal error when reading or writing the I ² C bus.
-08 INVALID COMMAND	Invalid command.
-09 COMMAND NOT ALLOWED IN CURRENT OPERATING MODE	Invalid command in current operating mode.
-10 VALUE TOO SMALL	Entered value too small.
-11 VALUE TOO LARGE	Entered value too large.
-12 TEMPERATURE MEASUREMENT ALARM	Error in A/D converter.
-13 WARNING : VALUE EXCEEDS TEMPERATURE LIMITS	Value lies outside the adjusted range for the high and low temperature warning limits. But value is stored.
-14 EXCESS TEMPERATURE PROTECTOR ALARM	Excess temperature protector alarm 
-15 EXTERNAL SENSOR ALARM	External control selected, but external Pt100 sensor not connected.
-20 WARNING: CLEAN CONDENSOR OR CHECK COOLING WATER CIRCUIT OF REFRIGERATOR	Cooling of the condenser is affected. Clean air-cooled condenser. Check the flow rate and cooling water temperature on water-cooled condenser.
-21 WARNING: COMPRESSOR STAGE 1 DOES NOT WORK	Compressor stage 1 does not work.
-26 WARNING: STAND-BY PLUG IS MISSING	External standby contact is open. (see page 55 and 68)
-33 SAFETY SENSOR ALARM	Excess temperature sensor short-circuited or interrupted.
-38 EXTERNAL SENSOR SETPOINT PROGRAMMING ALARM	Ext. Pt100 sensor input without signal and setpoint programming set to external Pt100.
-40 NIVEAU LEVEL WARNUNG	Low liquid level warning in the internal reservoir.

13. JULABO Service – Online remote diagnosis

JULABO circulators of the HighTech series are equipped with a black box. This box is implemented in the controller and records all significant data for the last 30 minutes.

In case of a failure, this data can be read out from the unit by using special software. This software is available as a free download from www.julabo.com.

- Installation is easy and is performed step by step. Please observe the instructions.



- Data read-out is possible in the conditions "OFF", "R OFF" or "ALARM".
- Connect the circulator to the computer using an interface cable.
- Start the EasyBlackBox program. The program asks for the port used (COM1,) and the baud rate of the unit. You do not have this information on hand? Simply try it out! The program continues to send the request until the correct settings are made.

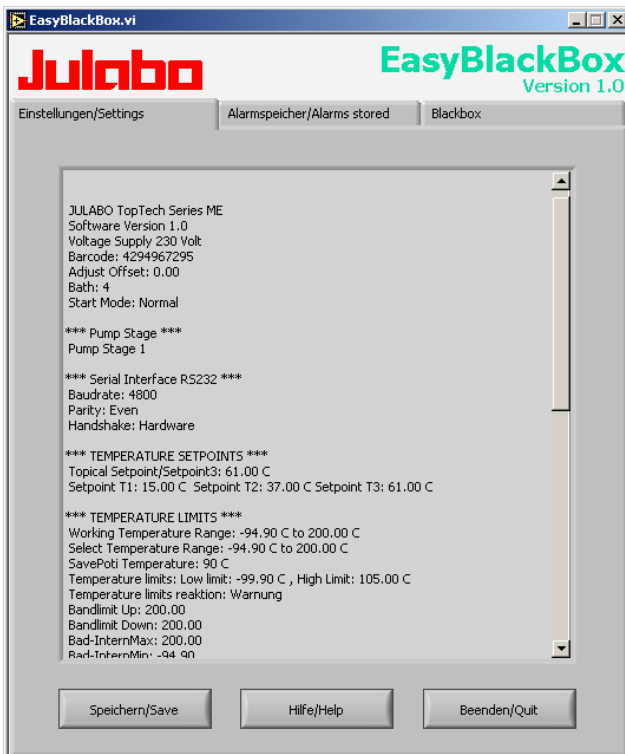

- Data is read out and shown on the monitor divided in the sections >Einstellungen/Settings<, >Alarmspeicher/Alarms stored<, >Blackbox<

← see example

- After pressing >Speichern/Save< a text file is compiled. The program proposes a filename - >C:\model description and barcode no.<. Modifications are possible.
- E-mail this file to service.usa@julabo.com, JULABO's service department. JULABO is thus able to provide rapid support.

14. Installation of electronic module



Caution:

Always turn off the unit and disconnect the mains cable from the power source before performing any service or maintenance procedures, or before moving the unit. Configuration, installation, maintenance and repairs on the Cryo-Compact Circulator may only be carried out by qualified personnel.

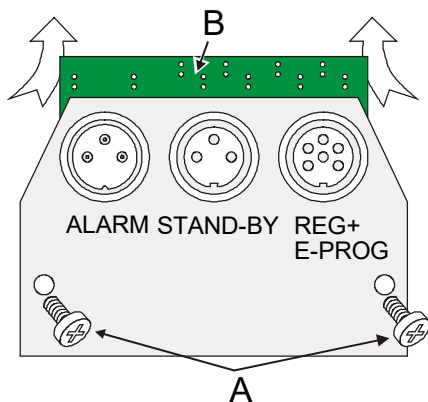

- Turn off the unit with the mains switch and disconnect the power plug.
- Open the screws (A) and remove the dummy plate.
- Carefully insert the upper edge (B) into the rear panel from below, align the electronic module at top and bottom and applying light pressure connect the 15-pole connector.
- Attach the electronic module using the screws (A).
- The Cryo-Compact Circulator is ready for use. It automatically recognizes the installed electronic module.

14.1. Draining



Notice:

Do not drain the bath fluid while it is hot!

Check the temperature of the bath fluid prior to draining (by switching the unit on for a short moment, for example).

Store and dispose the used bath fluid according to the laws for environmental protection.

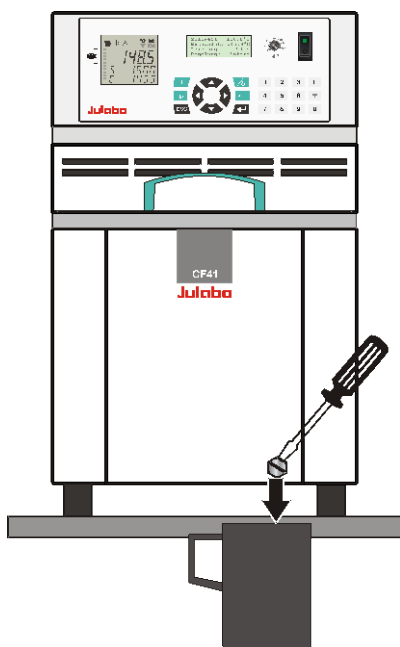

Draining

- Turn off the unit and disconnect the mains cable from the power source.
- Place the Cryo-Compact Circulator near the rim of the table. Use a suitable vessel as recipient for the bath liquid.
- Unscrew the drain tap and empty the unit completely.
- Tighten the drain tap.

15. Cleaning / repairing the unit



Caution:

- Always turn off the unit and disconnect the mains cable from the power source before cleaning the unit.
- Prevent humidity from entering into the circulator.
- Service and repair work may be performed only by authorized electricians.

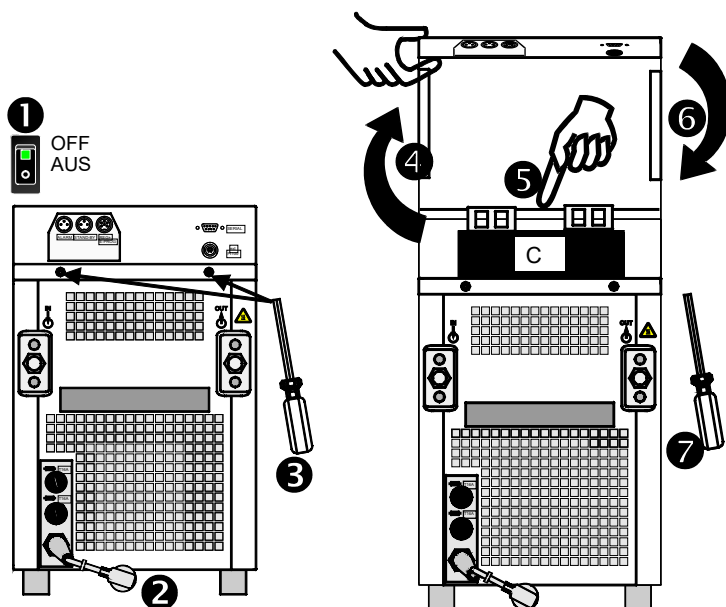

To maintain the full cooling performance, clean the condenser (C) from time to time.

1. Switch off device by pressing the main power switch and
2. disconnect mains cable from power source.
3. Remove 2 screws
4. Lift cover upwards.
5. Remove dirt at condenser by suction cleaning.
6. Close cover and
7. Fix by means of screws.
8. Unit is ready for operation.

Cleaning:

Clean the outside of the unit using a wet cloth and low surface tension water. The Cryo-Compact Circulator is designed for continuous operation under normal conditions. Periodic maintenance is not required.

The tank should be filled only with a bath fluid recommended by JULABO. To avoid contamination, it is essential to change the bath fluid from time to time.

Repairs:

Before asking for a service technician or returning a JULABO instrument for repair, please contact an authorized JULABO service station.

JULABO Technical Service

Tel.: +1(610) 231-0250 Option 3

Fax: +1(610) 231-260

Email: Service@julabo.us

When returning the unit:

- Clean the unit in order to avoid any harm to the service personnel
- Attach a short fault description.
- When returning a unit, take care of careful and adequate packing.
- JULABO is not responsible for damages that might occur from insufficient packing.



JULABO reserves the right to carry out technical modifications with repairs for providing improved performance of a unit.

16. WARRANTY PROVISIONS

The following Warranty Provisions shall apply to products sold in North America by Julabo ("Seller") to the entity shown as buyer ("Buyer") on Seller's invoice.

Initial Warranty

Upon Seller's receipt of payment in full for the products and subject to Buyer's compliance with the terms of sale and any other agreement with Seller relating to the products, Seller warrants to the Buyer that the products manufactured by the Seller are free from defects in material and workmanship for a period not to exceed two (2) years of operation from the date the product is shipped by Seller to Buyer (the "Initial Warranty").

EXCLUSION OF ALL OTHER EXPRESS WARRANTIES; EXCLUSION OF ALL IMPLIED WARRANTIES.

OTHER THAN THE INITIAL WARRANTY, NO OTHER EXPRESS WARRANTIES ARE MADE. ALL IMPLIED WARRANTIES OF EVERY TYPE AND KIND, INCLUDING BUT NOT LIMITED TO ANY IMPLIED WARRANTY OF MERCHANTABILITY OR FITNESS FOR A PARTICULAR PURPOSE OR USE, ARE EXCLUDED IN ALL RESPECTS AND FOR ALL PURPOSES. SELLER DISCLAIMS AND MAKES NO IMPLIED WARRANTIES WHATSOEVER.

Exclusions

The Initial Warranty does not include damage to the product resulting from accident, misuse, improper installation or operation, unauthorized or improper repair, replacement or alteration (including but not limited to repairs, replacements, or alterations made or performed by persons other than Seller's employees or authorized representatives), failure to provide (or use of improper) maintenance, unreasonable or unintended use or abuse of the product, or failure to follow written installation or operating instructions.

Buyer must return the product's record of purchase to the Seller or one of Seller's authorized representatives within thirty (30) days of the date the product is shipped by Seller to Buyer in order to make a claim under the Initial Warranty. Notwithstanding anything contained herein to the contrary, all glassware, including but not limited to reference thermometers, are expressly excluded from the Initial Warranty.

Buyer's sole remedies; Limitations on Seller's Liability

Buyer's sole and exclusive remedy under the Initial Warranty is strictly limited, in Seller's sole discretion, to either: (i) repairing defective parts; or (ii) replacing defective parts. In either case, the warranty period for the product receiving a repaired or replaced part pursuant to the terms of the Initial Warranty shall not be extended. All repairs or replacements performed by Seller pursuant to these Warranty Provisions shall be performed at one of the Seller's facility in Allentown, Pennsylvania, U.S.A. or at the facility of an authorized representative of Seller, which location shall be determined by Seller in its sole discretion; provided, however, that Seller may, in its sole discretion perform such repairs or replacements at Buyer's facility in which case Buyer shall pay Seller's travel, living and related expenses incurred by Seller in performing the repairs or replacements at Buyer's facility. As a condition precedent to Seller's obligation to repair or replace a product part under the Initial Warranty, Buyer shall (i) promptly notify Seller in writing of any such defect; (ii) shall have returned the product's record of purchase to Seller or to Seller's authorized representatives within thirty (30) days of the date the product is shipped by the seller; and (iii) assist Seller in all respects in its attempts to determine the legitimacy and basis of any claims made by or on behalf of Buyer including but not limited to providing Seller with access to the product to check operating conditions. If Buyer does not provide such written notice to Seller within the Initial Warranty period or fails to return the product's record of purchase as set forth above, Seller shall have no further liability or obligation to Buyer therefor. In no event shall Seller's liability under the Initial Warranty exceed the original purchase price of the product which is the subject of the alleged defect.

THE REMEDIES PROVIDED IN THE INITIAL WARRANTY ARE THE SOLE AND EXCLUSIVE REMEDIES AVAILABLE TO THE BUYER. NOTWITHSTANDING ANYTHING TO THE CONTRARY CONTAINED HEREIN, AND EVEN IF THE SOLE AND EXCLUSIVE REMEDIES FAIL OF THEIR ESSENTIAL PURPOSE FOR ANY REASON WHATSOEVER, IN NO EVENT SHALL SELLER BE LIABLE FOR BUYER'S MANUFACTURING COSTS, LOST PROFITS, GOODWILL, OR ANY OTHER SPECIAL, INDIRECT, PUNITIVE, INCIDENTAL OR CONSEQUENTIAL DAMAGES TO BUYER OR ANY THIRD PARTY AND ALL SUCH DAMAGES ARE HEREBY DISCLAIMED.

Assignment

Buyer shall not assign any of its rights or obligations hereunder without the prior written approval of Seller; provided, however, that if Buyer is a distributor of Seller, the rights and obligations of Buyer under these Warranty Provisions shall inure to the benefit of and be binding upon Buyer's customers who provide the product's proof of purchase to Seller pursuant to the terms set forth herein. Seller may assign any or all of its rights or obligations hereunder without Buyer's prior consent.

Governing Law

The Warranty Provisions and all questions relating to their validity, interpretation, performance, and enforcement shall be construed in accordance with, and shall be governed by, the substantive laws of the Commonwealth of Pennsylvania without regard to its principles of conflicts of law.

Waiver

Any failure of the part of Seller to insist on strict compliance with the Warranty Provisions shall no way constitute a waiver of such right. No claim or rights arising out of a breach of the Warranty Provisions by Buyer may be discharged in whole or in part by a waiver of the claim or right, unless the waiver is in writing signed by an authorized representative of Seller. Seller's waiver or acceptance of any breach by Buyer of any provisions of the Warranty Provisions shall not constitute a waiver of or an excuse for nonperformance as to any other provision of the Warranty Provisions nor as to any prior or subsequent breach of the same provision.

Freight

Seller will arrange and pay for shipping and handling for the return of the unit to the Buyer.

Out of Box Failure (OBF)

An Out of Box Failure (OBF) is defined as a product failure immediately following unpacking and installation of a newly delivered product. JULABO provides a 14-day grace period after the date of shipment, during which time the delivered product must be checked for defect. The same exclusions that apply to the regular warranty also apply to OBF classification. For example, JULABO will not be liable for transport damage, damage inflicted by the customer or any other party, or defects arising from improper installation or usage.