

# MAGIO™ MX



**Bridge-mounted, bath and heating circulators**

**Original operating manual**

1.950.1750.us.V05

12/2022

---

## **Legal**

JULABO USA, Inc.  
884 Marcon Boulevard  
Allentown, PA 18109  
Phone: +1(610) 231-0250  
Fax.: +1(610) 231-0260  
Info@julabo.us  
www.julabo.us

The content of this operating manual is protected by copyright. Information, including texts, images, and other contents may not be reproduced, distributed, transmitted, stored or otherwise used in any form without prior explicit written consent.

Illustrations in this operating manual are for illustrative purposes and are not necessarily displayed to scale.

---

## Contents

<b>1</b>	<b>Foreword</b> .....	<b>8</b>
<b>2</b>	<b>About this manual</b> .....	<b>9</b>
2.1	Original JULABO spare parts.....	9
2.2	Accessories.....	9
2.3	Warnings.....	10
2.4	Symbols used.....	11
<b>3</b>	<b>Intended use</b> .....	<b>11</b>
<b>4</b>	<b>Safety</b> .....	<b>12</b>
4.1	Safety instructions.....	12
4.2	Safety symbols.....	14
4.3	Safety function.....	14
<b>5</b>	<b>Product description</b> .....	<b>16</b>
5.1	Product overview.....	16
5.2	Function description.....	16
5.3	Operating and functional elements.....	17
5.4	Interfaces.....	18
5.4.1	Connection of Pt100 temperature sensor.....	18
5.4.2	Stakei output.....	19
5.4.3	RS232/RS485 interface.....	20
5.4.4	Ethernet interface.....	21
5.4.5	USB-A interface.....	21
5.5	Analog interfaces (accessories).....	22
5.5.1	Alarm output.....	22
5.5.2	REG/EPROG socket.....	23
5.5.3	Standby input.....	24
5.6	Operating interface.....	24
5.6.1	Softkeys and status icons.....	25
5.6.2	Explanation of abbreviated terms.....	26
5.7	Alarm messages.....	26
5.8	Operator Messages.....	27
5.9	Main menu.....	28

---

5.9.1	Adjust safety menu.....	28
5.9.2	Menu Determine thermodynamics.....	28
5.9.3	Menu Connect unit.....	29
5.9.4	Menu Use programmer.....	29
5.9.5	Record data menu.....	29
5.9.6	Install unit menu.....	30
5.9.7	Settings menu.....	30
5.9.8	Unit account menu.....	30
5.9.9	Service menu.....	30
5.9.10	Menu About.....	30
5.10	Technical data.....	31
5.10.1	Material of parts that come into contact with the medium.....	33
5.10.2	Bath fluids.....	34
5.10.3	Hoses.....	35
<b>6</b>	<b>Transport and installation.....</b>	<b>36</b>
6.1	Transporting the device.....	36
6.2	Install the device at the operating location.....	37
<b>7</b>	<b>Initial operation.....</b>	<b>38</b>
7.1	Setup Wizard.....	38
7.2	Mounting the circulator.....	38
7.2.1	Mount bridge mounted circulator.....	38
7.2.2	Mount heating or refrigerated circulator.....	39
7.3	Connect the device to the power supply.....	41
7.3.1	Connect bridge mounted or heating circulator.....	41
7.4	Connecting an external system.....	42
7.4.1	Connect an external system with screw connections.....	43
7.4.2	Connect an external system with barbed fittings.....	44
7.5	Switch on the device and set the language.....	45
7.6	Set high temperature safety function.....	46
7.7	Fill device.....	47
7.8	Set limit values.....	47
7.8.1	Set temperature warning limits.....	47
7.8.2	Adjusting setpoint limits.....	48
7.8.3	Adjusting actual value limits.....	48
7.8.4	Band limit for external control.....	48

---

7.8.5	Setting band limit.....	49
7.9	Connect external temperature sensor .....	50
<b>8</b>	<b>Operation .....</b>	<b>51</b>
8.1	Switch on the unit.....	51
8.2	Switch off the unit.....	51
8.3	Start temperature control application.....	51
8.4	Basic settings .....	52
8.4.1	Set language.....	52
8.4.2	Change language to English .....	52
8.4.3	Set date and time .....	52
8.4.4	Activate autostart function .....	53
8.4.5	Set physical units .....	53
8.5	Unit account .....	53
8.5.1	Change password .....	54
8.5.2	Defining user-dependent settings.....	54
8.5.3	Defining user-independent presets .....	55
8.5.4	Log in user .....	55
8.5.5	Log out user .....	55
8.5.6	Lock the device .....	56
8.5.7	Set inactivity timer .....	56
8.5.8	Reset settings .....	57
8.6	Record data.....	57
8.6.1	Record measurement data.....	57
8.6.2	Reading out blackbox data.....	58
8.6.3	Displaying alarm memory.....	58
8.7	Thermodynamics.....	58
8.7.1	Control parameter .....	58
8.7.2	Optimizing temperature curves .....	60
8.7.3	Adjust controller .....	61
8.7.4	Limit cooling capacity and heating capacity .....	61
8.7.5	Adjust pump .....	62
8.8	Remote control device.....	62
8.8.1	Remote control device using USB interface.....	62
8.8.2	Set RS232 interface parameters.....	63
8.8.3	Remote control device using RS232 interface .....	63

---

8.8.4	Remote control device using RS485 interface .....	64
8.8.5	Set EPROG input .....	64
8.8.6	Set actual value source .....	65
8.8.7	Set external setpoint values .....	65
8.8.8	Set up actuating variable .....	66
8.8.9	Request device status .....	66
8.9	Watchdog function .....	67
8.10	Working with the programmer .....	67
8.10.1	Setting the timer .....	68
8.10.2	Creating and editing a temperature control profile .....	69
8.10.3	Import temperature control profile .....	69
8.10.4	Export temperature control profile .....	70
8.10.5	Delete temperature control profile .....	70
8.10.6	Profile series setup .....	70
8.10.7	Activate programmer .....	71
8.11	Configure signal outputs .....	72
8.11.1	Set up Stakei outlet .....	72
8.11.2	Configure signal outputs of the REG/EPROG plug .....	72
8.11.3	Configure alarm outputs .....	73
8.12	Activating stand-by input .....	73
8.13	Adjusting the temperature sensor (ATC) .....	73
8.13.1	Adjust internal temperature sensor .....	74
8.13.2	Adjust the internal temperature sensor - multi-point calibration 74	
8.13.3	Adjust external temperature sensor .....	75
8.14	Device Reset .....	76
<b>9</b>	<b>Maintenance .....</b>	<b>77</b>
9.1	Check safety symbols .....	77
9.2	Check the functionality of high temperature cut-off .....	77
9.3	Test the low liquid level safety function .....	77
9.4	Replace detachable power cord .....	78
9.5	Check and replace fuse .....	78
9.6	Emptying .....	79
9.7	Clean device .....	79
9.8	Device storage .....	80

---

9.9	Technical Service .....	81
9.10	Warranty.....	81
<b>10</b>	<b>Disposal .....</b>	<b>84</b>
10.1	Device disposal .....	84
<b>11</b>	<b>Appendix.....</b>	<b>85</b>
11.1	Interface commands.....	85
11.1.1	IN commands .....	86
11.1.2	OUT commands .....	89
11.1.3	Status commands .....	92
11.1.4	Status messages.....	92
11.2	Alarms and Warnings.....	93
11.3	Modbus TCP/IP register.....	97
11.3.1	Data type.....	97
11.3.2	Feedback on invalid entries.....	97
11.3.3	Function codes.....	98
11.3.4	Holding registers .....	98
11.3.5	Input register .....	101

## 1 Foreword

### **Congratulations!**

You have made an excellent choice.

JULABO would like to thank you for the trust you have placed in our company and products.

This operating manual will help you become acquainted with the use of our units. Read the operating manual carefully. Keep the operating manual handy at all times.



---

## 2 About this manual

This manual is intended for the equipment specified on the cover page.



### NOTE

#### **Observe the safety instructions!**

Read the Safety section of this manual before using the equipment for the first time.

---

### 2.1 Original JULABO spare parts

Hassle-free continuous operation and safety also depend on the quality of the spare parts used.

Only original JULABO spare parts guarantee the highest possible quality and safety. Original JULABO spare parts are available directly from JULABO or your specialist dealer.

Please note that JULABO cannot provide a warranty service if non-original JULABO spare parts are used.

---

### 2.2 Accessories

JULABO offers a wide range of accessories for the devices. Accessories are not described in this manual.





The complete range of accessories for the devices described in this manual can be found on our website [www.julabo.com](http://www.julabo.com). Use the Search function on the website.

## 2.3 Warnings

---

The manual contains warnings to increase safety when using the device. Warnings must always be observed.

A warning sign displayed in signal color precedes the signal word. The signal word, highlighted in color, specifies the severity of the hazard.

	<p><b><i>DANGER</i></b></p> <p>This signal word designates a danger with a high level of risk which, if it not prevented, will result in death or serious injuries.</p>
	<p><b><i>WARNING</i></b></p> <p>This signal word designates a danger with a medium level of risk which, if it not prevented, may result in death or serious injuries.</p>
	<p><b><i>CAUTION</i></b></p> <p>This signal word designates a danger with a low level of risk which, if it not prevented, may result in minor to moderate injuries.</p>
	<p><b><i>NOTE</i></b></p> <p>This signal word designates a possibly harmful situation. If it is not avoided, the system or objects in its vicinity may be damaged.</p>

---

## 2.4 Symbols used

---

Various symbols are used throughout this manual to aid reading comprehension. This list describes the symbols used.

- ✂ Tools needed for the following approach
- ▶ Prerequisite to be met for the following procedure
- 1. Numbered action steps
- ↪ Interim result for individual action steps
- 👉 Additional note for individual action steps
- ✓ Final result of a procedure
- <> Terms in angle brackets denote control menu
- [] Terms in square brackets denote keys, softkeys and buttons

## 3 Intended use

This section defines the purpose of the unit so that the operator can operate the unit safely and avoid misuse.

JULABO circulators are laboratory devices that are designed for temperature control applications with liquid media in a bath tank or with a cooling machine. An external loop circuit can be connected to the pump connectors so that the temperature of the bath media can be kept constant.

Only use the device if it is in technically perfect condition and only use it in accordance with its intended use. Be aware of safety issues or hazards and comply with the operating manual! In particular, always immediately rectify faults that could impair safety!

The circulators are not suitable for direct temperature control application of food, other consumables or pharmaceutical or other medical products.

The devices are not suitable for use in an explosive environment.

The devices are not intended for use in living areas. They may cause interference with radio reception.

## 4 Safety

### 4.1 Safety instructions

---

The unit is built in accordance with state of the art technology and recognized safety regulations. Despite this, its use may pose a risk to life and limb for the user or third parties.

Therefore, always read and observe the following safety instructions before using the product.

#### **Hot surfaces!**

The following parts and elements may become hot during operation:

- Bath fluid
- Heating element
- Bath lid
- Bath surface
- Connections for external application

Contact may cause severe burns or scalds to hands and arms, face and limbs.

- Keep sufficient distance from hot surfaces and fluids.
- Wear suitable protective gloves.

#### **Electric shock from electrical system!**

Touching damaged live parts can cause severe electric shocks and lead to injury or even death.

- Have damaged insulation and parts of the electrical system immediately repaired by JULABO service technicians or a qualified specialist workshop
- Immediately replace damaged power cords
- When connected with a mains plug, this mains plug must always be readily accessible

#### **Wear personal protective equipment!**

Lacking or unsuitable personal protective equipment increases the risk of health damage and injury.

Personal protective equipment includes, for example:

- Work gloves
- Safety shoes
- Protective clothing
- Breathing protection
- Hearing protection
- Face and eye protection

- Specify and provide personal protective equipment for the respective application.
- Use only personal protective equipment that is in good condition and provides effective protection.
- Adapt personal protective equipment to the person, e.g., by size.

**Keep safety symbols legible!**

Safety symbols on the unit warn of dangers in hazardous areas and are an important part of the unit's safety equipment. Missing safety symbols increase the risk of injury to persons.

- Clean dirty safety symbols.
- Replace damaged and unrecognizable safety symbols immediately.





**Maintenance and repair work!**

Improper maintenance and repair work jeopardizes operational safety. This can result in serious injury or death.

- Only carry out work described in this operating manual. Switch off the unit and disconnect it from the power supply before carrying out any work.
- All other maintenance and repair work may only be carried out by a JULABO service technician or a qualified specialist workshop.

## 4.2 Safety symbols

There are safety symbols included with the device, which should be attached to the device before initial operation.

Safety symbols	Description
	Warning of a danger zone. Note operating manual
	Warning about hot surface
	Warning of cold surface
	Read operating manual before switching on

## 4.3 Safety function

Technical protective devices provide for safe operation. If a safety function is triggered, the operator is alerted with a message on the display and an acoustic signal.

### Adjustable high temperature cut-off

The high temperature cut-off prevents overheating of the heater.

- If the measured temperature rises above the set protective temperature, an error message is shown on the display. The pump and heater are switched off. A restart is required.

### **Overheating protection**

The overheating protection prevents overheating of the heater.

- The protective mechanism is triggered when the device recognizes a temperature difference of more than 20 K between the working temperature sensor and the safety temperature sensor. An error message appears on the display. A restart is required.

### **Low liquid level protection**

A level switch recognizes when the bath fluid fill level in the bath tank is too low. The device has a two-stage warning system to prevent overheating of the heater or dry running of the pump.

- The low liquid level warning is triggered when the liquid level in the bath tank is about half the full level. A warning message appears on the display. The bath fluid should be topped up.
- The low liquid level alarm is triggered when the float reaches its lower limit stop. The device switches off the pump and heater. A continuous signal tone sounds. A warning message appears on the display. A restart is required.

## 5 Product description

### 5.1 Product overview

---

Circulators can be combined with various baths and cooling machines.

#### Bridge mounted circulator



MAGIO MX-Z: Circulator with extendable telescopic bridge for mounting on open bath tanks

#### Heating circulator



Circulator with closed stainless steel bath tank.  
Example:  
MAGIO MX-BC4 for temperature control applications in the bath or externally

### 5.2 Function description

---

This section describes the function of the device.

The thermostats are used for internal and external temperature control and operate in a temperature range from ambient temperature to +300 °C, depending on the device combination and accessories used. When mounted on a bath tank, the circulator becomes a heating circulator.



### 5.3 Operating and functional elements

The following figure shows the operating and functional elements and their position on the unit.

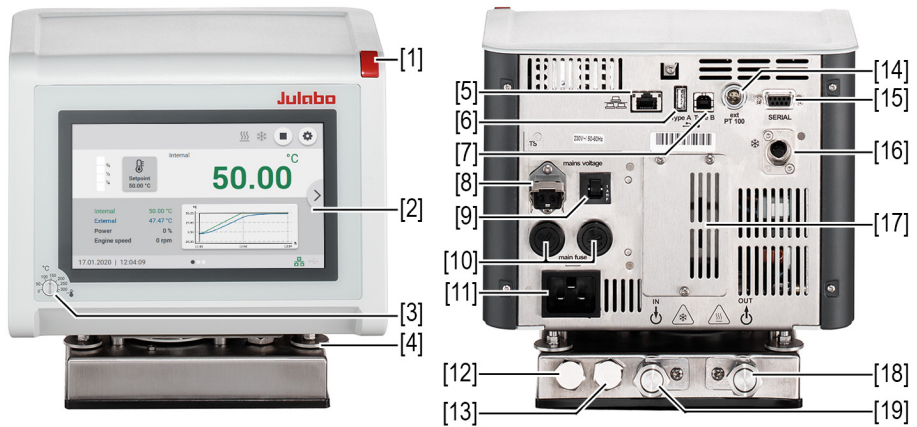

#### Control and function elements

1	Mains switch
2	Touchscreen
3	High temperature cut-off setting
4	Mounting screws
5	Ethernet interface
6	USB interface Type A
7	USB interface Type B
8	Stakei outlet, secured
9	Fuse for Stakei output, resettable
10	Mains fuse
11	Mains connection
12	Water connection for cooling coil
13	Water connection for cooling coil
14	Interface for external temperature sensor

15	RS232/RS485 interface
16	CAN plug for connection with a refrigeration unit
17	Cover for electronics slide-in module with analog connections (accessories)
18	Supply pump connection
19	Pump connection return line

## 5.4 Interfaces

This section describes the electronic interfaces on the device.

For safe operation, the interfaces must be operated according to their corresponding permissible specifications.

### 5.4.1 Connection of Pt100 temperature sensor

The plug ext. Pt100 is used to connect an external Pt100 temperature sensor. The following section describes the wiring of the plug as well as the connection cable of the temperature sensor.

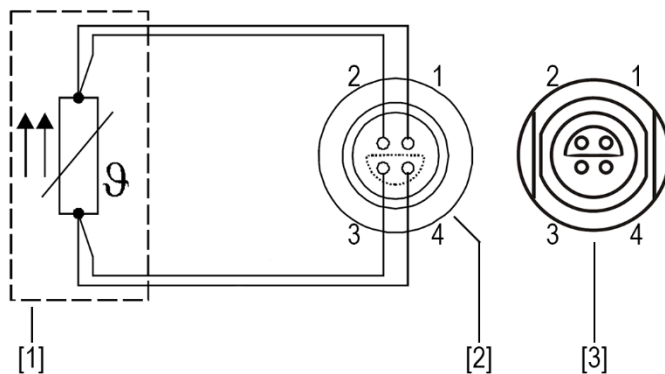

*Connection of a external Pt100 temperature sensor*

- [1] Temperature sensor Pt100
- [2] Plug, view of solder side
- [3] Connection socket on device

Pin	Signal
1	I+
2	U+
3	U-
4	I-

### 5.4.2 Stakei output

The Stakei output is a control output that can be adjusted to solenoid valves with various tasks via the operating menu. The desired function is set and activated in the operating menu.

The Stakei output can be assigned the following functions:

- **Refill device:**  
The Stakei output switches on when a low liquid level warning is triggered. If the level of the bath fluid drops below a certain level, the Stakei output turns on and a connected refilling device can be activated. This pumps bath fluid into the bath tank until the filling level has returned to a non-critical level.
- **Cooling pulse:**  
This function is controlled by the current cooling capacity of the device. If the temperature setpoint is lower than the actual temperature detected by the device, a pulse-width modulated signal is sent via the Stakei output. This signal can be used to control a solenoid valve for cyclic counter-cooling via a cooling coil.
- **Backflow:**  
This function is used as backflow protection in a system where the connected application is physically higher than the circulator. When the pump is running, the Stakei output is switched on and a check valve inserted between the circulator and the application can be controlled. This prevents the bath fluid flowing from the application to the bath tank while the pump is not running and causing the bath tank to overflow.

Technical data	Stakei output
Mains connection 100-115 V	100-115 V/1 A
Mains connection 200-230 V	200-230 V/1 A

If the fuse has tripped: press to reset. If it cannot be reset, contact Technical Service.

### 5.4.3 RS232/RS485 interface

The RS232 or RS485 interface is a 9-way D-sub socket for connecting the device to a PC.

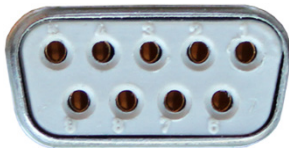

*RS232/RS485 socket*

RS232 interface pin assignment			
Pin 2	RxD receive data	Pin 7	RTS request to send
Pin 3	TxD transmit data	Pin 8	CTS clear to send
Pin 5	0 V signal GND		

*Pins 1, 4, 6 and 9 are reserved. Do not use.*

RS485 interface pin assignment			
Pin 3	B	Pin 6	+5 V (max. 50 mA)
Pin 5	0 V signal GND	Pin 8	A

Pins 1, 2, 4, 7 and 9 are reserved. Do not use.

RS232/RS485 interface factory settings	
Parity	straight
Baud rate	4800 baud
Handshake (RS232)	Hardware

Address (RS485)	0
Data bit	7
Stop bit	1

#### 5.4.4 Ethernet interface

The device can be connected to a network or directly connected to a PC using the Ethernet interface.

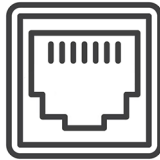

*Ethernet interface*

#### 5.4.5 USB-A interface

USB sticks can be connected to the USB-A interface. This unit is capable of reading data from the USB stick as well as saving data to the USB stick.

<b>Technical data for USB-A interface</b>	
Output voltage	5 VDC
Maximum current	500 mA

## 5.5 Analog interfaces (accessories)

The module with analogue interfaces can be ordered as an accessory.

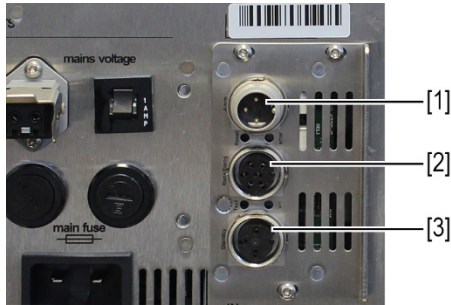

*Slot with analogue connections*

- [1] Alarm output
- [2] REG/EPROG plug
- [3] Standby input

### 5.5.1 Alarm output

The alarm output is a potential-free changeover contact, through which an externally connected circuit can be switched.

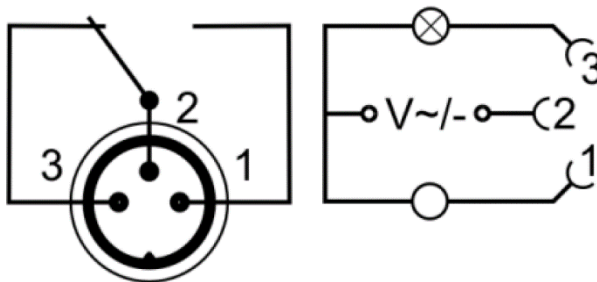

*Alarm output diagram*

In the **<Analog module>** menu, a defined state can be selected as the trigger for the **<Alarm output>**.

When the respective state is reached, pins 2 and 3 are connected:

- Standby
- Alarm
- Alarm + Standby

When the respective state is reached, pins 1 and 2 are connected:

- Standby/Inverse
- Alarm/Inverse
- Alarm + Standby/Inverse

#### Alarm output technical data

Maximum switching capacity	30 W/25 VA
Maximum switching voltage	30 VDC/25 VAC
Maximum switching current	1 A

### 5.5.2 REG/EPROG socket

The REG/EPROG socket has three signal outputs and one signal input.

A signal transmitter connected to the programmer input can specify the setpoint temperature or performance as a variable. The input signal can be a voltage source or a current source.

The signal outputs can be used at the same time. Two of the three output channels are designed as voltage outputs, the third as a current output.

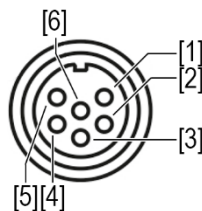

- [1] Voltage output channel 1  
(0-10 VDC, max. 10 mA)
- [2] Voltage output channel 2  
(0-10 VDC, max. 10 mA)
- [3] Gnd for outputs (0 V)
- [4] EPROG programmer  
(0-10 VDC/0-20 mA, max. 24 VDC)
- [5] Current output channel 3  
(4-20 mA/0-20 mA, max. 24 VDC)
- [6] Gnd for EPROG programmer (0 V)

*REG/EPROG socket diagram*

### 5.5.3 Standby input

With the standby socket the device can be put in standby mode using an external signal transmitter.

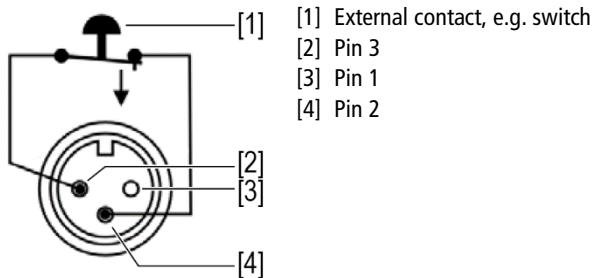

*Standby socket diagram*

### 5.6 Operating interface

The device is operated by touchscreen. When it is switched on, the display shows the home screen. Sideways swiping or pressing the side arrows allows selection between three different home screen presentations.

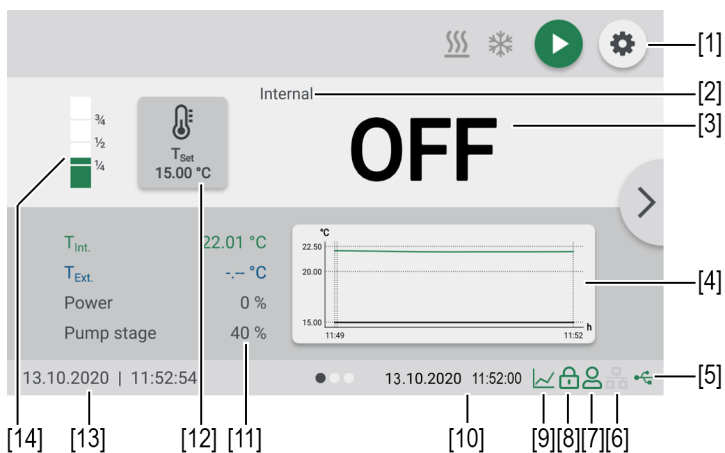





*Home screen*



- [1] Softkey **[Settings]** accesses the **<Main menu>**
- [2] Internal/external control display
- [3] Display of current internal/external temperature, display off in standby mode
- [4] Temperature sequence setpoint temperature/current temperature internal and external
- [5] Status USB
- [6] Status Ethernet
- [7] User logged in
- [8] Operation locked
- [9] Quick access programmer (with active programmer)
- [10] Status display programmer (with active programmer)
- [11] Display of current performance parameters
- [12] Softkey **[Setpoint adjustment]**, display of specified setpoint temperature
- [13] Date/time
- [14] Fluid level display

### 5.6.1 Softkeys and status icons

This section describes the softkeys and status icons found on the operating interface.

Softkey	Function
	With the softkey <b>[Start]</b> a temperature control application is started
	With the softkey <b>[Stop]</b> a temperature control application is stopped
	With the softkey <b>[Settings]</b> the <b>&lt;Main menu&gt;</b> is called up
	With the softkey <b>[Close]</b> the <b>&lt;Main menu&gt;</b> is closed and the <b>&lt;Home screen&gt;</b> is called up
Symbol	Description
	Heating is active
	Cooling is active

## 5.6.2 Explanation of abbreviated terms

The following abbreviations are used on the Home screen:

<b>Abbreviations</b>	<b>Explanation</b>
T <sub>Set</sub>	Setpoint temperature
T <sub>Over. warn.</sub>	Overtemperature warning
T <sub>Sub. warn.</sub>	Subtemperature warning
T <sub>Over. alarm</sub>	Overtemperature alarm
T <sub>Sub. alarm</sub>	Subtemperature alarm
T <sub>Protect.</sub>	High temperature cut-off
T <sub>Safety</sub>	Safety temperature sensor temperature
T <sub>Set max.</sub>	Maximum setpoint temperature
T <sub>Set min.</sub>	Minimum setpoint temperature
T <sub>Max int.</sub>	Maximum internal temperature
T <sub>Min int.</sub>	Minimum internal temperature
Band high	Lower bandlimit
Band low	Upper bandlimit
Pump max.	Maximum adjustable pump capacity
T <sub>Int.</sub>	Internal actual temperature
T <sub>Ext.</sub>	External actual temperature

## 5.7 Alarm messages

---

Errors or disturbances are indicated on the Home screen by alarm messages or warnings. Tapping the message displays a help text. Important error code descriptions can be found in the appendix. If you are unable to rectify a fault, contact Technical Service.



*Display of alarm message*

**Alarm:**

In the event of an alarm, the temperature control application is stopped. The actuators are switched off. At the same time, a continuous acoustic signal sounds and an alarm message with a red background is shown on the display. The signal tone can be deactivated by touching the touchscreen. The fault causing the alarm must be remedied. A restart is required.



*Display of warning message*

**Warning:**

In the event of a warning, the temperature control application is not interrupted. A warning message with an orange background is displayed. A signal tone is emitted at intervals. The acoustic signal can be deactivated by pressing the central controller. If the underlying cause of the warning is remedied, the signal tone ceases. Depending on the cause, warnings may cease automatically after a period of time, e.g. when the device cools down.

## 5.8 Operator Messages

---

Operator messages are informal messages that inform the operator about status changes of the device.



*Display of operator message*

Operator messages are shown on a blue background. They provide information about the operating states of individual units on the Home screen. Status messages from a connected cooling machine are also displayed as operator messages.

## 5.9 Main menu

---

With the softkey [**Settings**] on the home screen, you can call up the Main menu. The Main menu is divided into menu options, which respectively contain more submenus or in which settings can be specified. With the softkey [**Close**] you can always get back to the home screen.

The <**Main menu**> is divided into the following menu options:

- Adjust safety
- Determine thermodynamics
- Connect unit
- Use programmer
- Record data
- Install unit
- Settings
- Unit account
- Service
- About

### 5.9.1 Adjust safety menu

In the menu <**Adjust safety**> limit values are set to define a range for safe process flow.

- Enabling/disabling autostart
- Setting pump mode
- Setpoint limits: Setting of the upper and lower limits for temperature setpoint as well as the maximum pump performance
- Temperature limits: High temperature cut-off. Setting alarm and warning limits, band limits and internal temperature limits in the case of external control

### 5.9.2 Menu Determine thermodynamics

In the menu <**Determine thermodynamics**> the control parameters for a temperature sequence are defined and the pump performance set.

Adjust controller:

- Setting for the control parameters for internal or external control
- Definition of the control behavior

Adjust pump:

- Setting pump output

Adjust limits:

- Specification of the limit values for heating capacity and cooling capacity

External actual value source:

- Select the signal source for the actual value

### 5.9.3 Menu Connect unit

The device can be connected to a PC and remotely controlled via the USB interface, the RS232/RS485 interface or via Ethernet. In addition to this, analog interfaces of external programmers can also be connected. In the menu **<Connect unit>** parameters for remote control mode can be set.

- Setting up remote control
- Interfaces
- Watchdog function
- Start up behavior
- External setpoint
- Actuating variable
- Actual value

### 5.9.4 Menu Use programmer

The menu **<Use programmer>** is used to program temperature curves, which can be called up according to definable rules.

- Activate programmer: Set the start time, setpoint, final state, duration and number of runs of a temperature control application. Programming profile series
- Manage profile: Creating, managing, importing and exporting profiles. Graphical display of individual profile courses

### 5.9.5 Record data menu

The device can record data on an external storage medium. The menu **<Record data>** defines the conditions for this and starts recording. The recorded data can be used for subsequent evaluation.

- Recording measurement data
- Reading out blackbox data  
Reading out the alarm memory

### 5.9.6 Install unit menu

In the menu **<Install unit>** several basic settings are specified. Depending on the device constellation, not all menu functions are available.

- Adjust external temperature sensor
- Import and export device settings
- Reset device
- Set power supply
- Set chiller mode
- Activate and deactivate booster heater

### 5.9.7 Settings menu

In the menu **<Settings>** the fundamental device settings are specified.

- Setting language
- Setting date and time
- Setting physical units
- Configuration of Home screen

### 5.9.8 Unit account menu

Access rights are managed in the **<Unit account>** menu.

- Log in and out of the device
- Lock the device
- Set inactivity timer
- Access rights for basic and advanced users

### 5.9.9 Service menu

The menu **<Service>** is reserved for JULABO service technicians and password protected.

### 5.9.10 Menu About

The menu **<About>** provides information about the installed software status.

- Display of device identity with voltage variant and firmware status
- Display of installed open source software with licenses

## 5.10 Technical data

Performance specifications measured in accordance with DIN12876. Cooling capacities up to 20°C measured with ethanol; over 20°C with thermal oil unless specified otherwise. Performance specifications apply at an ambient temperature of 20°C. Performance values may differ with other bath fluids.

Grouping of the device acc. to CISPR 11:

- The device is an ISM device of group 1, which uses high frequency for internal purposes
- Class A: Use in an industrial electromagnetic environment

In accordance with IEC 61010-1, the device is designed for safe operation under the following ambient conditions:

- Indoor use
- Altitude up to 2000 m above sea level
- Ambient temperature +5 ... +40°C
- Maximum relative humidity 80% for temperatures up to 31°C, decreasing linearly down to 50% relative humidity at 40°C
- Mains voltage fluctuations up to  $\pm 10\%$  of the nominal voltage permissible if not otherwise specified
- Pollution degree level 2

Protection class according to EN 60 529:

- Protection class IP21

### MAGIO MX

#### Temperature control application

Working temperature range	°C	+20 ... +300
Temperature stability	°C	$\pm 0.01$
Temperature resolution	°C	0.01
Temperature control		ICC
Temperature setting		Digital
Absolute Temperature Calibration (ATC)		10-point adjustment

<b>Pump</b>					
Pump capacity*	%	40	60	80	100
Volume flow	l/min	16	22	27	31
Supply pressure	bar	0.24	0.44	0.68	0.92
Suction pressure	bar	0.16	0.27	0.37	0.40
Maximum viscosity	cSt	70			
<b>Dimensions</b>					
Dimensions (W x D x H)	cm	23 (MX-Z: 34) x 19 x 41			
Immersion depth	cm	20.0			
Weight	kg	7.6			
<b>Display</b>					
Display		7" TFT LCD			
Resolution		1024 x 600			
Function		10-point multi-touch function			
<b>Performance data</b>					
Mains connection		200-230 V 50/60 Hz			
		200 V 50/60 Hz	230 V 50/60 Hz		
Current consumption	A	14	15		
Heating capacity	kW	2.3	3.0		
Mains fuse 2x		T16A 6.3 x 32 mm			

\* Pump stages of the previous model correspond with the following pump output: 1=55 %, 2=65 %, 3=75 %, 4=85 %



### 5.10.1 Material of parts that come into contact with the medium

The table lists parts that could come into contact with the bath fluid as well as the material that the parts are made of. This data can be used to check the compatibility of the parts with the bath fluid used.

<b>Parts that come into contact with the medium</b>	<b>Material</b>
Motor shaft	1.4301
Pump	1.4301/1.4307
Pump connection	1.4401
Heating element	1.4404
Inbuilt temperature sensor Pt100	1.4571
Float	1.4404
Float rod	1.4301
Hose olive	1.4301
O-ring	Viton FPM 75

## 5.10.2 Bath fluids

The most important criterion when selecting the bath fluid is the working temperature range in which the application is operated.

- Selection of the bath fluid must ensure that the flash point is never exceeded when it comes into contact with the ambient air.
- Recommended bath fluids and further information can be found on our website



### NOTE

#### **No liability accepted for usage of bath fluids that are not suitable!**

Unsuitable bath fluids that are not approved by JULABO can damage the water bath.

- Use bath fluids that are recommended by JULABO
- Before filling, check the parts that are in contact with the medium for compatibility with the bath fluid
- Do not exceed the maximum permissible viscosity during operation
- Consult JULABO before using a bath fluid other than the recommended one



### NOTE

#### **Material damage caused by freezing water!**

Freezing water can damage the device and the sample.

- When using water as the tempering fluid, do not temper below 5°C

#### **Water as bath fluid**

- Water can be used for working temperatures from +5 °C to +90 °C
- Recommended: Use only ultrapure or distilled water.
- When using ultrapure or distilled water, add 0.1 g Na<sub>2</sub>CO<sub>3</sub> per liter of water.

#### **Recommended bath fluid**

- JULABO Thermal G

### 5.10.3 Hoses

Hoses for connection of an external system must suit the working temperature range and the respective temperature control application.

Hoses for every area of application can be found on our website.

Hoses must meet the following requirements:

- Temperature resistance
- Pressure resistance
- Suitable material properties for the bath fluid used

## 6 Transport and installation

This section describes how to transport the unit safely.

### 6.1 Transporting the device

A circulator can be transported with the closed bath when mounted.

	<b>CAUTION</b>
	<p><b>Risk of crushing by falling device!</b></p> <p>A device that is not secured appropriately can fall down during improper transport and cause crushing injuries.</p> <ul style="list-style-type: none"> <li>• Secure the device against tipping and falling during transport</li> <li>• Secure loose parts against falling during transport</li> <li>• Transport the device upright and with a suitable means of transport</li> <li>• Wear personal protective equipment</li> </ul>

	<b>CAUTION</b>
	<p><b>Burn hazard on the heating element!</b></p> <p>The heating element may still be hot even after the device has been switched off, and may cause burns if touched.</p> <ul style="list-style-type: none"> <li>• Allow the device to cool down to room temperature after switching off</li> <li>• Wear protective gloves</li> </ul>

- ▶ The device is switched off and emptied.
  - ▶ A suitable transport trolley is available.
1. Disconnect the mains cable from the device.
  2. If necessary, disassemble the temperature control hoses of the external system.
  3. Lift the device by the recessed handles - if necessary, by two persons - and place it centered on the transport trolley.
- ☞ See the technical data for weight information.
4. Secure the device on the transport trolley with straps to prevent it from tipping over.
  5. Place loose parts for the device, such as cables, on the transport trolley.
- ✓ The device is then ready for transport and can be safely transported to its installation location.

## 6.2 Install the device at the operating location

---

This section describes how the device is set up at the installation location.

- ▶ The device has been transported to the operation location.
  - ▶ The size and infrastructure of the operation location are suitable for device operation.
1. If possible, position the device under an extraction system.
  - ☞ Depending on the bath fluid, gases may be created at high temperatures.
  - ☞ Recommended minimum distance of 1 m to other devices, to prevent electromagnetic interference.
  2. Place the device on a level, smooth, non-flammable surface.
  3. Ensure that the device is securely positioned.
  4. For refrigerated circulators: Ensure an open space in front of and behind the device of at least 20 cm.
- ✓ The device is set up at the operation location.

## 7 Initial operation

Commissioning is carried out in various steps, depending on how the device is to be used.

### 7.1 Setup Wizard

---

The setup wizard starts the first time the unit is switched on. It guides you through various basic settings. When the setup wizard is complete, the unit is set up.

Start up the unit as described in this manual. Do not start the unit until you are prompted to do so in the relevant chapter.

### 7.2 Mounting the circulator

---

#### 7.2.1 Mount bridge mounted circulator

With the extendable telescopic bridge, the circulator can be mounted on open bath tanks with a width of 33 cm to 68 cm.

✂ Cross-headed screwdriver, size 2

- ▶ The circulator is equipped with the telescopic bridge.
- ▶ The bath is empty.

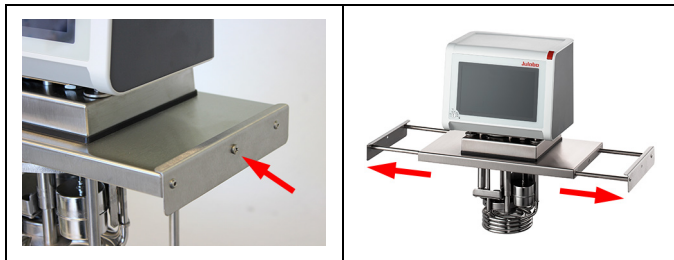

1. Dismount the two screws on the sides of the telescopic bridge.
2. Extend the telescopic bridge.

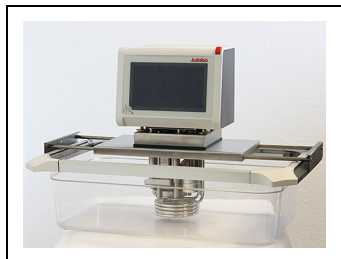

3. Carefully insert the circulator into the bath.
  4. Push the telescopic bridge together until the side angle plates rest against the edge of the bath.
- ✓ The thermostat is mounted on the open bath as a bridge mounted circulator.

## 7.2.2 Mount heating or refrigerated circulator

In the case of a heating circulator or a refrigerated circulator, the circulator is mounted on the closed bath or on cooling machine.

If the circulator is disassembled, e.g. due to a change of device or for service purposes, it can then be easily reassembled with the connecting box.

✂ Open-end spanner, size 7 mm

- ▶ The thermostat is ready to be mounted on a closed bath or a cooling machine.
- ▶ The bath is empty.

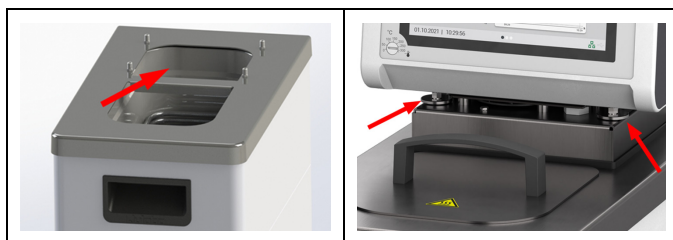

1. Carefully insert the circulator into the bath.
- ➔ Align the four threaded sleeves of the bath with the four fastening screws of the connecting box.
2. Tighten the four fastening screws [arrows in the image right] by hand.
3. Tighten the fastening screws evenly with the open-ended wrench.

4. Check that the circulator is sitting correctly and that the connecting box gasket is seated gap-free on the surface of the unit.
    - ✓ The heating circulator or refrigerated circulator is mounted.
- ▶ The circulator is ready to be mounted on a closed bath or cooling machine.  
▶ The bath is empty.

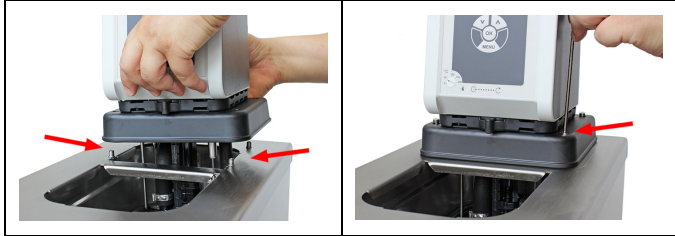

1. Carefully insert the circulator into the bath.
  - ↳ Align the bath's four threaded sleeves with the four holes on the connection box.
2. Place the four mounting screws into the holes on the connection box.
3. Tighten the mounting screws [right image].
4. Check that the circulator is seated correctly, and that the connection box gasket is seated on the unit surface without any gaps.
  - ✓ The heating circulator or refrigerated circulator is mounted.



## 7.3 Connect the device to the power supply

### 7.3.1 Connect bridge mounted or heating circulator

This section describes how the circulator is connected as a bridge mounted circulator or heating circulator.

- ▶ The circulator is mounted as a bridge mounted or heating circulator.
- ▶ The power cable is ready for use.



*Front side*

*Back*

1. Insert the power cable on the back of the circulator into the mains connection [1].
  2. Connect the circulator to the power supply using the power cable.
- ✓ The circulator is connected.

## 7.4 Connecting an external system

The device is designed for tempering external, closed loop systems. An external system is connected to the unit's pump connections.

	<b>CAUTION</b>
	<p><b>Risk of burns due to damaged temperature control hoses!</b> Hot bath fluid can escape from damaged temperature control hoses and cause serious burns when it comes into contact with skin.</p> <ul style="list-style-type: none"><li>• Check the temperature control hoses regularly for integrity</li><li>• Immediately replace damaged temperature control hoses</li><li>• Do not kink temperature control hoses</li><li>• Regularly exchange temperature control hoses</li><li>• Check the pump connections for leak tightness</li></ul>

	<b>NOTE</b>
	<p><b>Material damage due to incompatible externally connected system!</b> If the temperature range and/or pressure parameters of an externally connected system do not match those of the device this can result in damage to individual components or even failure of the entire system.</p> <ul style="list-style-type: none"><li>• Before connection check the external system for compatibility with the device combination</li><li>• If an external system is connected that is not set up for the maximum pressure of the device, the pump's flow rate must be limited in the settings</li><li>• If an external system is connected, the safety of the entire system is the responsibility of the operator</li></ul>

	<b>NOTE</b>
	<p><b>Hot pump connections!</b> The pump connections can become very hot during operation. Heat-sensitive parts or cables can be damaged if they have contact.</p> <ul style="list-style-type: none"><li>• Pump connections must be uncovered during operation</li><li>• No loose parts or cables should come into contact with pump connections during operation</li></ul>

**NOTE****Overflowing bath fluid due to externally connected systems!**

If the externally connected system is higher than the temperature control system, bath fluid can flow back and overflow when switched off.

- Position the connected external system on the same level or lower than the temperature control system
- Position a shut-off valve or Solenoid valve between the external system and the temperature control system as backflow protection.

**NOTE****Damaged hoses due to kinking!**

Hoses are damaged by kinking and can may leak.

- Lay hoses with large radii
- Avoid kinking of the hoses

### 7.4.1 Connect an external system with screw connections

This section describes how to connect an external, closed system to the device using screw connectors.

- ✂ Open-end wrench, 17 mm
- ✂ Open-end wrench, 19 mm

- ▶ The temperature control hoses of the external system are equipped with M16x1 female and barrel gaskets.

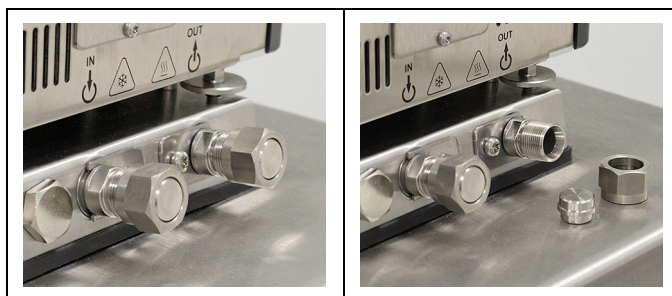

1. Disassemble the union nuts on the pump connectors.
2. Remove the sealing plugs.

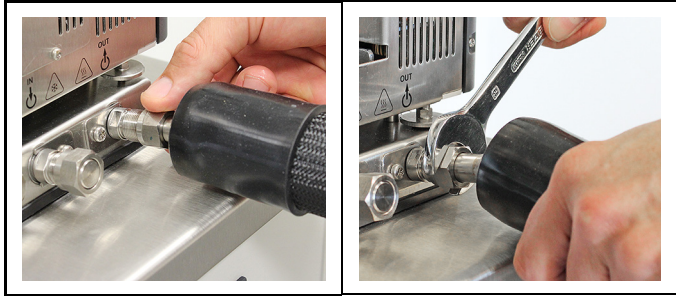

3. Screw the hoses onto the pump connectors by hand.
  - ☞ Pay attention to the supply and runback position.
4. Screw on the pump connections carefully with a maximum of 3 Nm torque.
  - ✓ The external system is connected.
  - ☞ If the external system is disassembled, the pump connections must be resealed with the sealing plugs so that no bath fluid can splash out during operation.

#### 7.4.2 Connect an external system with barbed fittings

This section describes how to connect an external, closed system to the device using barbed fittings.

- ✂ Open-end wrench, 17 mm
- ✂ Open-end wrench, 19 mm

- ▶ Barbed fittings are available for installation of the external system.

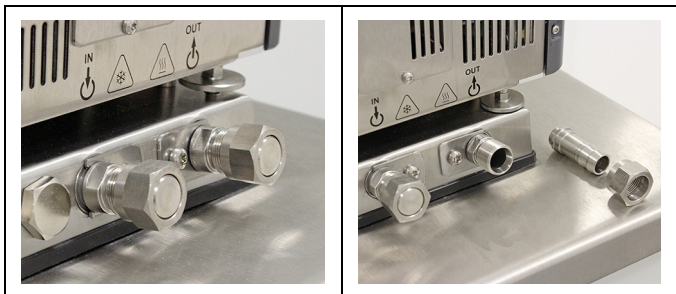

1. Disassemble the union nuts on the pump connectors.
2. Remove the sealing plugs.
3. Push one barbed fitting through each of the union nuts.

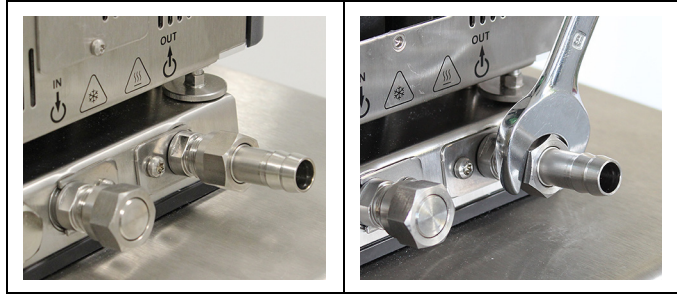

4. Mount the barbed fittings with the union nuts on the pump connections.
5. Carefully tighten the union nuts with a maximum of 3 Nm torque.
6. Attach the hoses of the external system on the barbed fittings.
- ☞ Pay attention to the supply and runback position.
7. Secure the hose against slippage using tube clamps.
- ☞ Check the hoses for secure and leak-proof fit.
- ✓ The external system is connected.
- ☞ If the external system is disassembled, the pump connections must be resealed with the sealing plugs so that no bath fluid can splash out during operation.

## 7.5 Switch on the device and set the language

The language must be set first, to prepare for important basic settings. When switching on for the first time, alarm messages may be shown on the display.

- ▶ The device is connected and ready for operation.
1. Switch the device on at the mains switch.
    - ➔ The software boots and starts the device. The display shows the device name, voltage version and software version.
    - ➔ Since no temperature liquid has been filled yet, the low level alarm is displayed.
    - ➔ Depending on the default setting, the high temperature cut-off alarm is displayed.
  2. Call up the **<Main menu>**.
  3. Call up the submenu **<Settings>** then menu option **<Language>**.
    - ➔ The submenu **<Language>** lists all the languages installed on the device.
  4. Select the desired language.
  5. Turn the device off so that the alarm message is reset.
  - ✓ The language is set.

## 7.6 Set high temperature safety function

Before each new temperature application, the temperature must be set for the tank and internal reservoir high temperature cut-off. Set a value that is at least 25 K below the flash point of the bath fluid being used. The surface temperature of the bath fluid must not exceed the flash point at any time. An alarm is triggered when the set value is exceeded.

✂ Slotted screwdriver, size 3

- ▶ The device is connected.
- ▶ The language is set.
- 1. Switch the device on.
- ↳ If no temperature liquid has been filled yet, the low liquid level alarm is displayed.
- ↳ Depending on the default setting, the high temperature cut-off alarm is displayed.
- 2. Call up the **<Main menu>**.
- 3. Call up the submenu **<Settings>** then menu option **<Customize home screen>**.
- 4. For one of the possible display values, activate **[High temperature cut-off]**.
- 5. Call up the Home screen.
- 6. Swipe sideways to show the Home screen view that displays the high temperature cut-off value  $T_{\text{Protect}}$ .

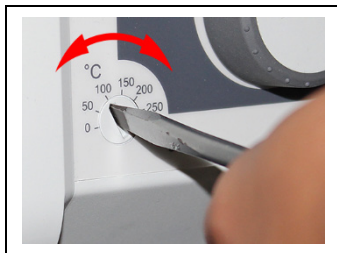

- 7. Use the screwdriver to set the high temperature cut-off.
- ↳ The display shows the set value for  $T_{\text{Protect}}$ .
- 8. Set a value that is at least 25 K under the flash point of the bath fluid being used.
- ↳ The set value is immediately active.
- 9. Turn the device off so that the alarm message is reset.
- ✓ The high temperature cut-off is set.

## 7.7 Fill device

---

This section describes how the device should be filled with bath fluid during initial operation.

Specifications for filling volume can be found in the technical data.

- ▶ The drain valve is closed.
- ▶ The device is switched off.
- 1. Remove the bath lid.
- 2. Half fill the bath with bath fluid.
- ☞ The bath fluid expands with increasing temperature and can overflow.
- ☞ With decreasing temperature, the low liquid level protection can be triggered and interrupt the temperature control process.
- 3. Switch the unit on and start the temperature control application.
- 4. Watch the level indicator and, if necessary, adjust the level by refilling or draining.
- ☞ Once the working temperature has been reached and the sample inserted, the level of bath fluid in the bath tank should cover the heating coil of the heating circulator or the cooling coil of the refrigeration unit.
- 5. Close the bath opening with the bath lid.
- ✓ The device is filled with bath fluid.

## 7.8 Set limit values

---

### 7.8.1 Set temperature warning limits

A warning limit and an alarm limit can be set for low temperature and high temperature. The warning limit values should be within the alarm limit values. If the respective temperature limit is exceeded, the device generates an alarm or warning message.

- ▶ The device is switched on.
- 1. Call up the **<Main menu>**.
- 2. Call up the submenu **<Adjust safety>**.
- ☞ Only values that are within the performance values of the device can be entered.
- 3. Set the limit value for the **[Overtemperature alarm]** then confirm your input with **[OK]**.
- 4. Set the limit value for the **[Overtemperature warning]** then confirm your input with **[OK]**.
- 5. Set the limit value for the **[Subtemperature alarm]** then confirm your input with **[OK]**.
- 6. Set the limit value for the **[Subtemperature warning]** then confirm your input with **[OK]**.
- ✓ The temperature limits are set.

## 7.8.2 Adjusting setpoint limits

The setpoint limits Setpoint max. and Setpoint min. define the upper and lower limit of the adjustable setpoint temperature range.

The setpoint limit for the pump defines the upper limit value for pump capacity, adjustable in the menu **<Determine thermodynamics>**. The lower limit is set to 40% ex works.

- ▶ The device is switched on.
- 1. Call up the **<Main menu>**.
- 2. Call up the submenu **<Adjust safety>**.
- 3. Set the **[Setpoint min.]**, **[Setpoint max.]** and **[Pump max.]** then confirm your input.
- ☞ Only values that are within the performance values of the device can be entered.
- ✓ The setpoint limits are set.

## 7.8.3 Adjusting actual value limits

The actual value limits "internal minimum" and "internal maximum" are effective in the external control operating mode. They define limits for the expected temperature in the internal bath. The temperature controller cannot exceed these limit values. Under certain circumstances, the external setpoint will not be reached.

- ▶ The device is switched on.
- 1. Call up the **<Main menu>**.
- 2. Call up the submenu **<Adjust safety>**.
- 3. Set the values for internal minimum and internal maximum.
- ✓ The actual value limits are set and immediately active.

## 7.8.4 Band limit for external control

If an external system is being controlled then there is a temperature difference both during the heating phase and the cooling phase due to inertia. The curve illustrates the connection between the internal and external temperature sequence.



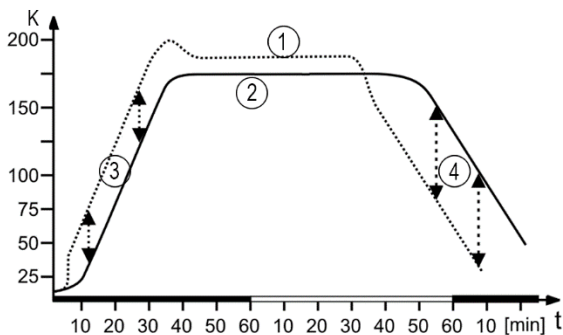

*Schematic temperature sequence internal/external*

- [1] Temperature sequence internal
- [2] Temperature sequence external system
- [3] Band limit upper
- [4] Band limit lower

In order to gently control the temperature of a sample in an external system, or to protect a glass reactor from thermal stress, for example, maximum permissible temperature differences can be specified for the heating phase and the cooling phase.

### 7.8.5 Setting band limit

The upper and lower band limit is defined in °K. In the heating phase the set value will be added to the external actual value. In the cooling phase the set value will be subtracted from the external actual value. The setting range is between 1 and 200 °K.

- ▶ The device is switched on.
  1. Call up the **<Main menu>**.
  2. Call up the submenu **<Adjust safety>**.
  3. Set the upper and lower band limit.
- ✓ The band limits are set and immediately active.

## 7.9 Connect external temperature sensor

---

A Pt100 temperature sensor can be attached to the rear of the device.

- ▶ The device is switched off.
- ▶ A Pt100 temperature sensor with suitable connection is available.
- 1. Connect the Pt100 to the ext.Pt100 socket on the back of the device.
- 2. Switch the device on.
- 3. Call up the submenu **<Determine thermodynamics>** and the menu option **<Adjust controller>**.
- 4. In the menu option **<Control>** activate the interface **[External control]**.
- 5. Call up the menu option **<External>**.
- 6. Set the control parameter for external control.
- ✓ The external temperature sensor is connected and ready for operation.

---

## 8 Operation

### 8.1 Switch on the unit

---

This section describes how to switch on the device.

- ▶ The unit is connected and ready for operation.
- 1. Switch the unit on at the mains switch.
- ➔ The software boots and starts the unit. The display shows the unit name, voltage version and software version.
- ✓ The unit is switched on. It switches to the most recently activated operating mode, manual mode of operation or remote control mode. If the auto start function is activated, then the unit starts directly into the last setting.
- ⚠ If remote control mode is enabled, operation at the device is not possible. First, deactivate the remote control mode.

### 8.2 Switch off the unit

---

This section describes how to switch off the device.

- ▶ The device is switched on.
- 1. Press the **[Stop]** softkey to stop an ongoing temperature control application.
- ➔ If a cooling machine is connected, a message appears on the display that the cooling machine is shutting down.
- ⚠ Do not switch off the device until the message has disappeared and the device is in standby mode.
- 2. Switch the device off at the mains switch.
- ✓ The device is switched off.

### 8.3 Start temperature control application

---

A temperature application can be started directly on the unit. Other options include timer-controlled temperature control application with the integrated programmer and remote control via a connected PC.

- ▶ The unit is switched on.
- 1. From the Home screen, press the **[Setpoint adjustment]** softkey.
- 2. Enter the desired setpoint temperature in the input window and confirm your input.
- 3. Press the **[Start]** softkey.

- ✓ The unit starts the temperature control application at once. The temperature control application can be stopped with the **[Stop]** softkey. The entered setpoint temperature is saved.
- ☞ Observe the following for heating circulators:  
For temperature control applications near or below the ambient temperature: Use a cooling coil or JULABO immersion cooler.

## 8.4 Basic settings

---

### 8.4.1 Set language

The language of the operating interface can be switched to one of the available languages.

- ▶ The device is switched on.
  1. Call up the **<Main menu>**.
  2. Call up the submenu **<Settings>** then menu option **<Language>**.
    - ☞ The submenu **<Language>** lists all the languages installed on the device.
  3. Select the desired language.
- ✓ The selected language is immediately activated.

### 8.4.2 Change language to English

A special function makes it easy to change the user interface language to English at any time.

- ▶ The device is switched on.
  1. Call up the **<Main menu>**.
  2. Tap the **<Main menu>** text field on the left menu item for more than 3 seconds.
- ✓ The language will be changed to English.

### 8.4.3 Set date and time

The date and time is preset ex works. This section describes how you can set the date and time yourself.

- ▶ The device is switched on.
  1. Call up the **<Main menu>**.
  2. Call up the submenu **<Settings>** then menu option **<Date/time>**.
    - ☞ The submenu shows the currently set date and time as well as selectable display formats.

3. Set the date and time with the keypad shown and then confirm your input with **[OK]**.
4. Select the desired display format.
- ✓ The date and time are set.

#### 8.4.4 Activate autostart function

The autostart function makes it possible to start a temperature control application directly using the mains switch or via an intermediate timer.

The device is configured ex works in such a way that it switches to a safe operating status in the event of power failure. The autostart function is deactivated. The display shows "OFF." The refrigeration aggregate, heater, and pump motor are disconnected from the mains voltage.

- ▶ The device is switched on.
- 1. Call up the **<Main menu>**.
- 2. In the submenu **<Adjust safety>** activate the interface **[Autostart]**.
- ✓ The autostart function is activated. The next time the device is switched on, the temperature control application will immediately start with the preset values. You can also insert and program a timer. In this case the mains switch of the device must remain on.

#### 8.4.5 Set physical units

The physical units for temperature, pressure and flow can be set in the menu.

- ▶ The device is switched on.
- 1. Call up the **<Main menu>**.
- 2. Call up the submenu **<Settings>**.
- 3. Set the desired units for temperature, pressure and flow.
- ✓ The physical units are set.

### 8.5 Unit account

---

In the menu option **<Unit account>** the access rights for user groups can be managed.

Basic users and advanced users can log in with this menu option. Logging in activates the respectively assigned rights.

The administrator manages the access rights of the two user groups and can change passwords.

### 8.5.1 Change password

The password ensures that only authorized persons have access to defined device functions. The administrator password is required to change a password. Passwords can be created and changed for the following user groups:

- Basic users, factory setting password: 0000
- Extended users, factory setting password: 00000
- Administrators, factory setting password: 000000

▶ The device is switched on.

1. Call up the **<Main menu>**.

2. In the submenu **<Unit account>** call up the menu option **<Settings>**.

↪ An input field will open.

3. Enter the administrator password and confirm your input.

☞ Factory setting for the administrator password: 000000.

4. Select one of the three user groups.

5. Press the **[Change password]** button.

↪ An input field will open. The new password may have up to 19 digits.

6. First think of a new password and make a note of it.

☞ Note: Entering a new password will overwrite the previous password. It can no longer be restored! This also applies to the password preset ex works.

7. Enter the new password and confirm your input.

8. Repeat the new password and confirm your input.

✓ The password has been changed and is immediately active. This allows you to change the password for each user group.

### 8.5.2 Defining user-dependent settings

The administrator manages the access rights of the user groups. For basic users and advanced users it is possible to define which main menus they can access and whether they are authorized to enter the setpoint or start and stop the device. A change to access rights requires the administrator password.

▶ The device is switched on.

1. Call up the **<Main menu>**.

2. In the submenu **<Unit account>** call up the menu option **<Settings>**.

↪ An input field will open.

3. Enter the administrator password and confirm your input.

☞ Factory setting for the administrator password: 000000.

4. Select a user group.

5. Activate/deactivate the desired access rights and menus.

✓ The settings for the user group are active immediately.

### 8.5.3 Defining user-independent presets

If no user is logged in, user-independent presets are based on operation of the device. For users who are not logged in, operation of the device may be limited to certain functions.

- ▶ The device is switched on.
- 1. Call up the **<Main menu>**.
- 2. In the submenu **<Unit account>** call up the menu option **<Settings>**.
  - ↳ An input field will open.
- 3. Enter the administrator password and confirm your input.
  - ☞ Factory setting for the administrator password: 000000.
- 4. Select the menu option **<Default values>**.
- 5. Activate/deactivate the desired access rights and menus.
- ✓ The user-independent preset values are active immediately.

### 8.5.4 Log in user

Logging in a user activates the access rights assigned to their user group.

- ▶ The device is switched on.
- 1. Call up the **<Main menu>**.
- 2. In the submenu **<Unit account>** press the **[Login]** button.
  - ↳ An input field will open.
- 3. Enter the password for your user group and confirm your input.
  - ☞ Basic users, factory setting password: 0000.
  - ☞ Extended users, factory setting password: 00000.
- ✓ The display shows the logged in user group. The access rights are active immediately. If the device is switched off and on again, the last logged in user group remains active.

### 8.5.5 Log out user

If an active user is logged out, the user-independent access rights that can be operated by any person are automatically activated.

- ▶ The device is switched on.
- 1. Call up the **<Main menu>**.
- 2. Call up the submenu **<Unit account>**.

3. Press the **[Logout]** button.
- ✓ You are immediately logged out and the user-independent access rights are activated.
- ☞ The current temperature control application remains active. If the user-independent access rights do not make it possible to stop or change an active temperature control application, a message appears indicating that access is blocked. The administrator or the last user can unlock the device.

### 8.5.6 Lock the device

A logged-in user can lock the device to prevent unwanted interventions. Active temperature control application is not interrupted. A locked device cannot be operated, it must first be unlocked by the last user or an administrator.

- ▶ The device is switched on.
- ▶ A basic user or advanced user is logged in.
- 1. Call up the **<Main menu>**.
- 2. Call up the submenu **<Unit account>**.
- ↳ The logged in user group is displayed.
- 3. Activate the **[Lock unit]** button.
- ✓ The device is unlocked. The lock symbol is displayed at the bottom edge of the home screen.

### 8.5.7 Set inactivity timer

After a defined period of inactivity on the display, the device is automatically locked. The inactivity timer can be set up by a logged-in user.

- ▶ The device is switched on.
- ▶ A basic user or advanced user is logged in.
- 1. Call up the **<Main menu>**.
- 2. Call up the submenu **<Unit account>**.
- ↳ The logged in user group is displayed.
- 3. Press the **[Idle time]** button.
- ↳ An input field will open.
- 4. Enter the duration for the inactivity timer in the specified time format and confirm your input.
- ↳ The duration is displayed on the **[Idle time]** button.
- 5. Activate the **[Idle timer]** button.
- ✓ The inactivity timer is set up and active. As soon as the duration of inactivity on the display has elapsed, the device is locked.



---

### 8.5.8 Reset settings

All settings in the **<Unit account>** menu can be reset to factory settings at any time. The administrator password is required to reset the settings.

- ▶ The device is switched on.
- 1. Call up the **<Main menu>**.
- 2. In the submenu **<Unit account>** call the menu option **<Settings>**.  
↳ An input field will open.
- 3. Enter the administrator password and confirm your input.
- ⚡ Factory setting for the administrator password: 000000.
- 4. Press the **<Reset>** button.
- 5. Acknowledge the confirmation prompt with **[OK]**.
- ✓ All unit account settings are reset to factory settings.

---

## 8.6 Record data

### 8.6.1 Record measurement data

Measurement data for an ongoing temperature control application can also be recorded onto a USB stick at the same time. The record documents the date, time, setpoint temperature, intern actual value, external actual value and the percentage power. The data is saved as a .txt file and can be subsequently analyzed.

- ▶ The device is switched on.
- ▶ A USB stick is available.
- 1. Call up the **<Main menu>**.
- 2. Call up the submenu **<Record data>**.  
↳ The warning appears: "No USB stick recognized!"
- 3. Insert the USB stick into the USB socket on the back of the device.
- 4. Press the button **[File]** to change the filename if required.
- 5. Press the button **[Sampling time]** and set the cycle in which measurement data should be recorded.
- 6. Activate the **[Activate]** button.
- ✓ The measurement data recording is started and this is shown with a red point on the home screen. The data is recorded on the USB stick using the specified filename. Stop recording by deactivating the **[Activate]** button.

## 8.6.2 Reading out blackbox data

The blackbox stores all relevant data from the last 30 minutes. In addition, the black box logs alarms and warnings.

The blackbox can be read out and the data sent to technical service for analysis.

- ▶ The device is switched on.
- ▶ A USB stick is available.
  1. Call up the **<Main menu>**.
  2. Call up the submenu **<Record data>**.
    - ↳ The warning appears: "No USB stick recognized!"
  3. Insert the USB stick into the USB socket on the back of the device.
  4. Scroll down the display to Blackbox and press the **[File]** button to change the displayed filename if required.
  5. Press the button **[Save]**.
- ✓ The blackbox data is saved onto the USB stick as a .txt file.

## 8.6.3 Displaying alarm memory

Alarm messages are stored with date, time, alarm code and unit identifier. The data can be read out via the menu.

- ▶ The device is switched on.
  1. Call up the **<Main menu>**.
  2. Call up the submenu **<Record data>** then the menu option **<Alarm memory>**.
    - ↳ The device lists the stored alarm messages. Individual alarm messages can be called up by tapping.
    - ☞ Alarm messages are cleared by swiping to the left and confirming the displayed delete icon.
- ✓ The alarm memory is displayed.

## 8.7 Thermodynamics

---

### 8.7.1 Control parameter

The device works with a PID control. Experience has shown that the control parameters set ex works achieve an optimal temperature sequence in the sample.

The internal and external control parameters can be adjusted in the submenu **<Determine thermodynamics> <Controller settings>**.

**Automatic**

The device independently calculates the control parameters during tempering and adjusts them automatically. It is not possible to manually change the control parameters and dynamics.

**Proportional range  $X_p$** 

The proportional range  $X_p$  is the temperature range between the setpoint value and the actual value, in which the heating capacity can be adjusted from 100% to 0%. The value for  $X_p$  can be selected between 0 K and 10 K.

**Integral controller  $T_n$** 

The integral controller  $T_n$  is indicated in seconds. It reduces the difference between the setpoint value and the actual value caused by the  $X_p$  component, and keeps to the setpoint value.

**Differential controller  $T_v$** 

The differential controller  $T_v$  is specified in seconds. It shortens the regulation time.

**Dynamics**

With internal control, **[Standard]** or **[Aperiodic]** can be selected for the control dynamics:

- With Aperiodic the temperature increase is temporally offset, so that the actual temperature doesn't overshoot
- With Standard the temperature increase is faster, but the actual temperature can overshoot by up to 5 %

**CoSpeed factor**

The CoSpeed factor affects the temperature sequence when used with external control. It directly affects  $X_{pu}$  and causes more aggressive temperature control.

**Proportional range  $X_{pu}$** 

The proportional range  $X_{pu}$  plays a role in external control. It corresponds with the proportional range  $X_p$  for internal control.

### 8.7.2 Optimizing temperature curves

The temperature sequence shown on the display provides information about how individual control parameters can be optimized to achieve a better result.

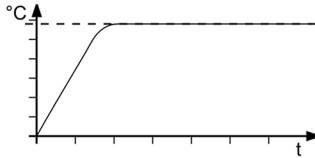

Optimal temperature sequence, temperature quickly reaches the setpoint without overshooting, and keeps the setpoint.

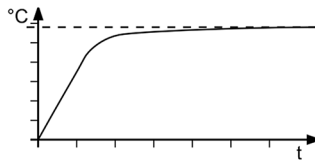

Symptom: Temperature sequence slowly approaches the setpoint and doesn't quite reach it.  
Solution: Decrease  $T_v$  and/or  $T_n$ , increase  $X_p$ .

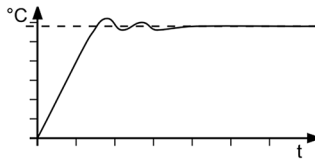

Symptom: Temperature sequence quickly approaches the setpoint, but overshoots it and oscillates.  
Solution: Increase  $T_v$  and/or  $T_n$ .

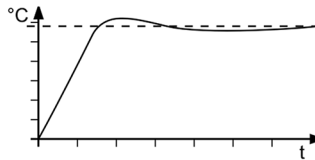

Symptom: Temperature sequence quickly approaches the setpoint and overshoots.  
Solution: Increase  $X_p$ .

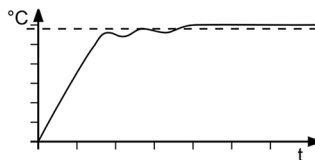

Symptom: Temperature sequence quickly approaches the setpoint, the temperature builds up and the setpoint is exceeded.  
Solution: Decrease  $X_p$  and/or  $T_v$ .

### 8.7.3 Adjust controller

In the menu **<Adjust controller>** the individual control parameters for internal and external control can be set.

- ▶ The device is switched on.
- 1. Call up the **<Main menu>**.
- 2. Call up the submenu **<Determine thermodynamics>** and the menu option **<Adjust controller>**.
- 3. Activate internal or external control.
- ☞ This results in the respective adjustable control parameters. External control is only possible with an externally connected Pt100 temperature sensor.
- 4. Switch to the submenu **<Adjust control performance>**.
- 5. Set the desired parameters.
- 6. For internal control: Activate the aperiodic temperature sequence or the standard temperature sequence.
- ✓ The control parameters are set and immediately active.

### 8.7.4 Limit cooling capacity and heating capacity

In the menu **<Adjust limits>** the cooling capacity and heating capacity are limited.

- ▶ The device is switched on.
- 1. Call up the **<Main menu>**.
- 2. Call up the submenu **<Determine thermodynamics>** and the menu option **<Adjust limits>**.
- 3. Set the limit values for the cooling capacity and the heating capacity.
- ✓ The values are set and are immediately active.

## 8.7.5 Adjust pump

The performance of the pump can be set in one-percent increments.

- ▶ The device is switched on.
- 1. Call up the **<Main menu>**.
- 2. Call up the submenu **<Determine thermodynamics>** and the menu option **<Adjust pump>**.
- 3. Enter the desired value for pump capacity in percent.
- ☞ The minimum value is defined internally. The maximum value is limited to the adjustable maximum pump capacity in the menu **<Adjust safety>**.
- 4. Confirm your input.
- ✓ The set value is immediately active. The pump is set.

To achieve low setpoint temperatures, it may be helpful to reduce the pump output in certain situations. This decreases the pump's heat input into the bath fluid.

## 8.8 Remote control device

---

The device can be connected to a PC via its interfaces and controlled remotely using a program such as ° EasyTemp. It is also possible to send interface commands to the device using a terminal.

The respective interface is set up when the remote control is deactivated.

If remote control mode is enabled, the device cannot be operated directly.

### 8.8.1 Remote control device using USB interface

The device can be remote-controlled via the standard USB B interface.

- ▶ The device is switched off.
- ▶ The computer has a terminal program installed.
- 1. Connect the device (USB plug type B) to the computer with a commercially available USB cable.
- 2. Download the suitable USB driver from the download area of the website [www.julabo.com](http://www.julabo.com).
- ☞ Depending on the operating system used by the connected computer, it may be necessary to install the USB driver.
- 3. Install the USB driver on the computer.
- 4. Switch the device on.
- 5. Call up the **<Main menu>** on the device.
- 6. In the submenu **<Connect unit>/<Remote control>** activate the USB interface.

- ➔ The home screen will show USB mode.
- 7. Start the terminal program on the computer.
- 8. Use the terminal program to select the COM port of the device and establish a connection.
- ✓ Remote control via the USB interface is activated. This is shown with the "USB" on the home screen. You can now remotely control the device with interface commands via the computer.

### 8.8.2 Set RS232 interface parameters

The interface parameters cannot be changed during remote control mode. If they differ from the factory settings, they must be set before remote control mode is activated.

- ▶ Remote control is deactivated.
- 1. Call up the thermostat in the **<Main menu>**.
- 2. Call up the **<Serial>** menu item in the **<Connect device>/<Interfaces>** submenu.
- 3. First select the desired mode.
- 4. Set the interface parameters **[Baud rate]**, **[Handshake]** and **[Parity]** if they differ from the factory settings.
- ☞ If parity is "None," the number of data bits is set to 8.
- ✓ The interface parameters are set and immediately active.

### 8.8.3 Remote control device using RS232 interface

The device can be remote-controlled via the RS232 interface. A null modem cable is required to connect to a PC.

- ▶ The device is switched off.
- ▶ The computer has a terminal program installed.
- 1. Connect the circulator with the computer using a null modem cable.
- 2. Switch the circulator on.
- 3. Call up the circulator on the **<Main menu>**.
- 4. In the submenu **<Connect unit>/<Interfaces>** activate the serial interface RS232.
- 5. In the submenu **<Connect unit>/<Remote control>** activate the "Serial" connection type.
- ➔ The Home screen will show RS232 mode.
- 6. Start the terminal program on the computer.

7. Enter the interface parameters into the terminal program.
8. Use the terminal program to select the COM port of the circulator and establish a connection.
- ✓ Remote control via the RS232 serial interface is activated. You can now remote control the circulators with interface commands via the terminal program. See appendix for interface commands.

### 8.8.4 Remote control device using RS485 interface

The device can be remote-controlled via the RS485 interface. A null modem cable is required to connect to a PC.

- ▶ The device is switched off.
  - ▶ The computer has a terminal program such as HTerm installed.
1. Connect the circulator and computer via the RS485 socket, e.g. with a USB to serial adapter.
  2. Switch the circulator on.
  3. Call up the circulator on the **<Main menu>**.
  4. In the submenu **<Connect unit>/<Interfaces>** activate the serial interface RS485.
  5. Enter an address for the RS485 interface.
  6. In the submenu **<Connect unit>/<Remote control>** activate the "Serial" connection type.
    - ↪ The Home screen will show RS485 mode.
  7. Start the terminal program on the computer.
  8. Enter the interface parameters into the terminal program.
  9. Use the terminal program to select the COM port of the circulators or the connected adapter, and establish a connection.
  - ✓ Remote control via the RS485 serial interface is activated. You can now remote control the circulators with interface commands via the terminal program. See appendix for interface commands.

### 8.8.5 Set EPROG input

The EPROG input can be used to send an external voltage or current signal to the circulator. Depending on the setting, the circulator interprets the input signals as a setpoint temperature, power capacity, flow or pressure, and can output the values as a display on the start screen.

Please note the technical data of the REG/EPROG socket.

- ▶ The unit is switched on.
  - ▶ The remote control mode is deactivated.
  - ▶ A signal transmitter is connected via the REG/EPROG socket.
1. Call up the **<Main menu>**.



2. Call up the submenu **<Connect unit>** then menu option **<Interfaces>**.
3. From the submenu **<Analog module>** select the menu option **<EPROG>**.
4. Select input variable **[setpoint]**, **[power]**, **[flow]**, **[pressure]** or **[current value]**.
5. Select the signal type voltage or current.
6. Use the connected signal transmitter to go to the lower voltage or current limit.
  - ➔ The value is displayed in the menu as the current value (V or A).
7. Tap the **[Low value]** button and enter the low input value (setpoint, performance, flow or pressure).
  - ➔ The value is displayed in the menu as the current value (°C, °F, %, l/min, gpm, bar, psi).
8. Repeat steps 6 and 7 for **[High value]**.
  - ✓ The EPROG input is set. In the submenu **<Settings>**, the values for display on the home screen can be selected. The setpoint temperature or performance can also be used as an external setpoint value or as an actuating variable. The actual value can be used as an actual value source.

### 8.8.6 Set actual value source

By default, the actual value is measured using a Pt100 temperature sensor. In addition, the unit offers the option of specifying the actual value via one of the interfaces.

- ▶ The unit is switched on.
  - ▶ The remote control mode is deactivated.
1. Call up the **<Main menu>**.
  2. In the submenu **<Determine thermodynamics>** call up the menu option **<Actual value source>**.
  3. Select Pt100, a digital interface or EPROG.
    - ⚡ EPROG can only be selected if the analog option is available and the "actual value" is defined as the input variable in submenu **<Analog module>** for EPROG.
  - ✓ The actual value source is set up.

### 8.8.7 Set external setpoint values

By default the setpoint is adjusted on the device or by the programmer. In addition to this, the device offers the ability to externally specify the setpoint using the analog REG/EPROG plug or an external Pt100 temperature sensor.

- ▶ The device is switched on.
  - ▶ The remote control mode is deactivated.
1. Call up the **<Main menu>**.

2. Call up the submenu **<Connect unit>** then menu option **<External setpoint>**.
3. Select Pt100 or EPROG.
  - ☞ Pt100 can only be selected if an external Pt100 temperature sensor is connected to the device. The setpoint is then set using the external temperature sensor.
  - ☞ EPROG can only be selected if the analog option is available and the setpoint is defined as the input variable in submenu **<Analog module>** for EPROG.
- ✓ The external setpoint value is defined.

### 8.8.8 Set up actuating variable

If the device is in remote control mode then the variable (capacity) with which the cooling unit or heater is controlled can be set using interface commands. This section describes how the actuating variable can be set.

- ▶ The device is switched on.
  1. Call up the **<Main menu>**.
  2. Call up the submenu **<Connect unit>** then menu option **<Actuating variable>**.
  3. Select Digital or Analog in the dialog window.
    - ☞ Digital can only be selected if remote control mode is activated.
    - ☞ Analogue can only be selected if the electronic module with analogue connections is available and has been defined as an input variable in the submenu **<Analogue module >** for EPROG.
- ✓ The actuating variable is set.

### 8.8.9 Request device status

The current device status can be queried via an interface command.

- ▶ The device is connected to a PC via an interface.
  1. Enter the command "status" in the terminal program and press **[Enter]**.
- ✓ The device responds with a status message. If an alarm or warning is pending, the device sends the respective alarm or warning message to the status query. Explanations of the status messages as well as alarm and warning messages can be found in the Appendix.

---

## 8.9 Watchdog function

---

During a temperature control application in remote control mode, the watchdog function monitors the active interfaces. In the event of a fault in the higher-level data processing system, the watchdog function ensures that the device switches to a previously defined safe operating status.

Cyclical data communication between the higher-level main computer and the device is crucial. If data transmission is interrupted for a pre-defined period, the watchdog function is activated.

Various conditions for safe operating status can be defined in the operating menu:

- **Mode:** Specifies how the device should react when the watchdog function is activated.
- **Timeout:** Defines how long data transfer from the main computer is permitted to be interrupted before the watchdog function is activated.
- **Setpoint:** Defines the setpoint temperature that is activated to put the unit in a safe state.
- **Restart mode:** Select whether the watchdog function should be reset when only the setpoint temperature is received or upon all valid commands.
- **Enabling/disabling warning.** A warning message can be transmitted when the watchdog function is enabled.
- **Reset warning message:** Here you can set whether the warning message is reset manually or automatically.

---

## 8.10 Working with the programmer

---

Temperature control profiles are defined temperature profiles with a setpoint temperature as well as a predefined temperature control duration or a predefined gradient. The programmer calculates a temperature ramp from these programmed values.

The programmer can start these temperature control profiles directly or with a time delay. The number of repetitions can be set, as can the start time and the days of the week on which the temperature control profile should run.

In order for programmed temperature control profiles to run automatically, the device must remain switched on.

**NOTE****Falling bath fluid level!**

In the case of a prolonged temperature control application, the level of bath fluid in the bath tank can fall below the alarm limit due to evaporation. A low liquid level alarm is triggered and temperature control application stops.

- In the event of a prolonged temperature control application, regularly check the fill level of bath fluid in the bath tank
- If the level is low, refill the bath fluid

### 8.10.1 Setting the timer

The timer can be used to program the duration of a tempering from 0 to 999 minutes and to program the start time. The target temperature is set as the setpoint temperature.

After the set duration has elapsed, the device switches to the previously defined state:

- Standby mode
- Maintain target temperature
- Temper to original setpoint temperature

► The device is switched on.

1. Call up the **<Main menu>**.
2. Call up the submenu **<Use programmer>** then the menu option **<Timer>**.

↪ The timer setting options are displayed in the submenu.

☞ No parameters can be changed when the timer is active. First deactivate the timer.

3. Use the **[Plan start]** button to set the desired start time and date then confirm your input.
  4. Set the **[Setpoint]** and the desired **[Duration]** then confirm your input.
  5. In the **[Final state]** field, select how the device should behave after the timer expires.
  6. Enable the **[Activate]** field to start the timer.
- ✓ The timer is programmed and active. The set duration starts to elapse once the setpoint temperature is reached.

### 8.10.2 Creating and editing a temperature control profile

Eight individual temperature control profiles can be created with up to 60 individual steps each. The programmer processes the programmed steps of a temperature control profile according to the specifications.

- ▶ The device is switched on.
- 1. Call up the **<Main menu>**.
- 2. Call up the submenu **<Use programmer>** then the menu option **<Programmer>**.
- 3. In the submenu **<Manage profile>** call up one of the profiles.
- 4. Call up the menu option **<Edit profile>**.
  - ➔ The existing steps of the profile are displayed. If there are no steps, the **[Add step]** softkey appears.
- 5. Tap on one of the displayed steps and select the step type via the **[Starting via]** button.
  - ➔ Depending on the step type, the parameter gradient or time is shown.
- 6. Enter the parameters using the softkeys **[Setpoint]** and **[Gradient]** or **[Time]** and confirm your input.
- 7. If necessary, add a new step to the current step using the soft key **[Add step]**.
  - ➔ The added step opens as an editable dialog window.
  - 👉 In the submenu **<Manage profile>**, you can use the **[Display profile]** button to display the created profile as a diagram.
- 8. When you have finished editing the temperature control profile, the soft key **[Back]** takes you back to the submenu **<Use programmer>**.
  - ✓ The temperature control profile has been created and saved.

### 8.10.3 Import temperature control profile

Temperature control profiles can be imported from another device via a USB stick.

- ▶ The device is switched on.
- 1. Insert the USB stick with a temperature control profile to be imported into the USB socket.
- 2. Call up the **<Main menu>**.
- 3. Call up the submenu **<Use programmer>** then the menu option **<Programmer>**.
- 4. In the submenu **<Manage profile>** call up a profile.
- 5. Tap the **[Import profile]** button.
- 6. In the dialog window, select the temperature control profile to be imported from the USB stick and confirm your input.
  - ➔ The temperature control profile is imported and saved in the selected profile on the device.
  - ✓ The temperature control profile is imported.

### 8.10.4 Export temperature control profile

Temperature control profiles can be exported to a USB stick, for example to be used on other devices.

- ▶ The device is switched on.
- 1. Insert an empty USB stick into the USB socket.
- 2. Call up the **<Main menu>**.
- 3. Call up the submenu **<Use programmer>** then the menu option **<Programmer>**.
- 4. In the submenu **<Manage profile>** call up a profile.
- 5. Tap the **[Export profile as]** button.
- 6. Enter a name for the profile to be exported and confirm your input.
- 7. Tap the **[Export profile]** button.
- ✓ The temperature control profile is exported to the USB stick as a .txt file and can be imported to other devices.

### 8.10.5 Delete temperature control profile

Existing temperature control profiles can be completely deleted. This deletes all saved profile data.

- ▶ The device is switched on.
- 1. Call up the **<Main menu>**.
- 2. From the submenu **<Use programmer>/<Programmer>** call up the menu option **<Manage profile>**.
- 3. Select a temperature control profile.
- 4. Press the **<Clear profile>** button.
- 5. Acknowledge the confirmation prompt.
- ✓ The temperature control profile will be deleted. Once all steps are removed, the **[Add step]** softkey remains in the deleted profile.

### 8.10.6 Profile series setup

The submenu **<Activate programmer>** is used to set up the sequence of a profile series. This defines the start time, the number of runs, the cycle and the behavior of the device at the end of the profile series.

- ▶ The device is switched on.
- 1. Call up the **<Main menu>**.
- 2. Call up the submenu **<Use programmer>** then the menu option **<Activate programmer>**.
- 3. Scroll down the menu page and select the sequence cycle with the **[Series type]** button.

- ☞ In addition to daily or weekly, individual weekdays can also be selected.
- 4. Use the **[Use end date]** button to select if the profile series should be ended on a certain date.
- 5. If necessary, enter the desired end date using the **[End date]** button.
- ☞ If no end date is used, the profile series will run until it is ended manually.
- ✓ The profile series is set up. If the programmer is activated, the profile series starts immediately or at the specified start time and runs through the selected profile according to the defined settings. Then the programmer will repeat the profile according to the set series type. After the profile series has been completed, the device switches to the defined final state. An ongoing profile series can be ended manually at any time.

### 8.10.7 Activate programmer

The programmer is started with a selected profile and runs through the profile according to the specifications.

- ▶ The device is switched on.
- ▶ The programmer is deactivated.
- 1. Call up the **<Main menu>**.
- 2. Call up the submenu **<Use programmer>** then the menu option **<Activate programmer>**.
- 3. First use the **[Select profile]** button to select the desired temperature control profile.
- 4. Use the **[Number of runs]** button to specify how often the selected profile should be repeated.
- 5. Use the **[Final state]** button to specify how the device should behave after the end.
- 6. Select the **[Plan start]** button to specify the start time and start date.
- ☞ When the programmer is activated, the start time is shown in the programmer status display on the home screen. As soon as temperature control application starts, the active profile is displayed.
- 7. Scroll up the menu page and activate the programmer.
- ✓ The programmer is activated. It starts either immediately or at the programmed start time on the specified start date and goes through the specified number of runs one after the other. After the last run, the device switches to the defined final state.
- ☞ When the programmer is active, the **[Quick access programmer]** button is displayed at the bottom of the home screen. Use this button to stop or end the programmer, or edit the active profile.

## 8.11 Configure signal outputs

---

### 8.11.1 Set up Stakei outlet

A solenoid valve connected to the Stakei output can be assigned various functions depending on the application.

- ▶ The device is switched on.
- ▶ A solenoid valve is connected to the Stakei output.
  1. Call up the **<Main menu>**.
  2. Call up the submenu **<Connect unit>** then menu option **<Interfaces>**.
  3. Use the **[Control output]** button to select the desired function for the connected solenoid valve.
- ✓ The Stakei output is set up and active.

### 8.11.2 Configure signal outputs of the REG/EPROG plug

The REG/EPROG socket provides three channels as signal outputs. The voltage or current signals emitted via these channels can be externally processed.

The following values can be output:

- Setpoint: Specified setpoint
  - Internal: Internal temperature sensor value
  - External: External Pt100 temperature sensor value
  - Performance: Value of the variable
- 
- ▶ The device is switched on.
  - ▶ The electronics module with analog connections is mounted.
    1. Call up the **<Main menu>**.
    2. Call up the submenu **<Connect unit>**.
    3. From the submenu **<Interfaces>**, select the menu option **<Analog module>**.
    4. For **[Channel 1]** select the output value setpoint, internal, external or capacity.
    5. Enter the lowest output value as the 0 V value.
    6. Enter the highest output value as the 10 V value.
    7. Repeat the steps 4 to 6 for **[Channel 2]**.
    - ☞ **[Channel 3]** configures the current output. 0 mA or 4 mA can be selected for the lowest output value.
    8. Enter the lowest output value as the 0 mA/4 mA value.
    9. Enter the highest output value for the 20 mA value.
  - ✓ The signal outputs of the REG/EPROG socket are configured.



---

### 8.11.3 Configure alarm outputs

This section describes how the alarm output is configured.

- ▶ The device is switched on.
- ▶ The electronics module with analog connections is mounted.
  1. Call up the **<Main menu>**.
  2. Call up the submenu **<Connect unit>**.
  3. From the submenu **<Interfaces>**, select the menu option **<Analog module>**.
  2. In the menu option **<Alarm output>**, select the condition to be used as trigger for a connected external circuit.
- ✓ The alarm output is configured.

---

### 8.12 Activating stand-by input

This section describes how standby input can be activated.

- ▶ The device is switched on.
- ▶ The electronics module with analog connections is installed.
  1. Call up the **<Main menu>**.
  2. Call up the submenu **<Connect unit>**.
  3. From the submenu **<Interfaces>**, select the menu option **<Analog module>**.
  4. Activate **[Standby]**.
- ✓ The standby input is activated and can be used.

---

### 8.13 Adjusting the temperature sensor (ATC)

For physical reasons, there can be a temperature difference in the bath tank between the temperature sensor and a defined, more remote point within the bath fluid volume. As a result, the measured temperature deviates slightly from the actual bath temperature. Adjustment of the temperature sensor can increase accuracy of the temperature control application.

The adjustment of a temperature sensor requires the determination of the temperature difference between the temperature sensor and the reference thermometer. Three adjustment options are available:

- 1-point adjustment: When a sample is tempered to a certain setpoint. The adjustment curve is displaced parallel to the original curve by the reference amount.
- 2-point adjustment: When the temperature is controlled between two setpoints. The slope of the temperature curve is adjusted between two points.
- Multi-point calibration: When temperature is controlled within a temperature range. This results in an arched temperature curve.

### 8.13.1 Adjust internal temperature sensor

This section describes how to adjust the internal temperature sensor of the device.

- ▶ The bath tank is filled.
  - ▶ The unit is switched on.
  - ▶ A calibrated reference thermometer is available.
1. Temper the sample to the desired setpoint temperature.
  2. Wait until the temperature in the bath has stabilized and is shown on the display of the circulator.
  3. Hang the reference thermometer in the bath tank near the tempered sample.
  4. Read the temperature value on the reference thermometer.
  5. Call up the **<Main menu>** and then the submenu **<Install unit>**.
  6. In the submenu **<Adjust temperature sensors>** select the function **<ATC internal>**.
  7. Press the **[Add new correction point]** button.
  - ↳ Two options are displayed for selection.
  8. If you press **[Accept current temperature]**, the current measured temperature is adopted and the dialog window for entering the corresponding correction value opens.
  9. When **[Enter temperature]** is pressed, the dialog window for entering the temperature value and correction value opens.
  10. Enter the required value and confirm your entry.
- ☞ The correction value is active immediately.
  - ✓ The internal temperature sensor is adjusted with a correction point.

### 8.13.2 Adjust the internal temperature sensor - multi-point calibration

This section describes how to adjust the internal temperature sensor of the device with multiple correction points. The adjustment can be performed with up to ten correction points.

- ▶ The device is switched on.
  - ▶ The bath tank is at least two thirds full.
  - ▶ A calibrated reference thermometer is available.
1. Initially proceed in the same way as for the 1-point adjustment.
  2. Go to the Home screen and enter the setpoint temperature for the next correction point.
  3. Wait until the temperature in the bath has stabilized and is shown on the display of the circulator.
  4. Go to the ATC submenu **<ATC internal>** and press the **[Correction point 1]** button or the button of the last correction point that was added.
- ↪ The correction point opens.
5. Press the button for a new correction point and proceed in the same way as described for the 1-point adjustment.
  6. Repeat steps 2 to 5 for each additional correction point and confirm your input in each case.
- ⌚ The correction values are active immediately.
  - ⌚ Up to ten correction points can be created for the adjustment.
  - ✓ The multi-point adjustment is completed. The internal temperature sensor is adjusted.

### 8.13.3 Adjust external temperature sensor

Measurable temperature differences can also occur in a connected application. As with the internal temperature sensor, adjustment of the external temperature sensor can improve accuracy of the temperature control application.

- ▶ The device is switched on.
  - ▶ The application is at least two thirds full.
  - ▶ A calibrated reference thermometer is available.
1. Temper the sample in the application to the desired setpoint temperature.
  2. Wait until the temperature in the application has stabilized and is shown on the display of the circulator.
  3. Hang the reference thermometer in the bath tank of the application near the tempered sample.
  4. Read the temperature value on the reference thermometer.
  5. Call up the **<Main menu>** of the circulator and then the submenu **<Install unit>**.
  6. In the submenu **<Adjust sensor>** select the function **<ATC external>**.
  7. Tap the **[Correction point 1]** button.

8. Enter the reference value in the input window and confirm your input.
  - ☞ The correction value is active immediately.
  - ✓ The external temperature sensor is adjusted.
  - ☞ Adjustment of the external temperature sensor, via up to ten correction points, is carried out in the submenu **<ATC external>** in the same way as adjustment of the internal temperature sensor.

## 8.14 Device Reset

---

The function resets the device to the factory settings.

- ▶ The device is switched on.
1. Bring up the **<Main menu>**.
  2. Call up the **<Reset device>** menu item in the **<Install device>** submenu.
  3. If you want to reset the device, confirm the security prompt with **[OK]**.
- ✓ The device is reset to factory settings.

---

## 9 Maintenance

### 9.1 Check safety symbols

---

The safety labels affixed to the device must be clearly legible at all times. Their condition must be checked every two years.

1. Check the safety signs on the device for legibility and completeness.
2. Replace defective or missing safety markings.
- ☞ Safety signs can be reordered from JULABO.
- ✓ The safety signs on the device have been checked.

### 9.2 Check the functionality of high temperature cut-off

---

This section describes how you can test that the high temperature safety function is operational.

✂ Slotted screwdriver, size 3

- ▶ The device is switched on.
1. Set the display of the start screen so that it shows the high temperature cut-off value.
  2. Use the screwdriver to adjust the overtemperature protection to a temperature that is below the displayed actual value.
    - ➔ An acoustic signal sounds and the alarm message "Set protective temperature exceeded" is displayed. The high temperature cut-off works.
  3. Then set a value that is above the actual value.
  4. Switch the device off, wait a few seconds, then switch the device on again.
    - ➔ The alarm message is deactivated.
  5. Set the high temperature cut-off.
    - ✓ The high temperature cut-off is set and its functionality tested.

### 9.3 Test the low liquid level safety function

---

This section describes how you can test that the low liquid level safety function is operational.

- ▶ The device is switched on.
1. Remove the bath lid.
  2. Using a long object, e.g. a straightedge, carefully push the thermostat float downwards until it reaches its mechanical stop.

- ➔ A beep sounds and the "Tempering fluid level too low" alarm message is displayed. The low liquid level safety function works.
- 3. Switch the device off, wait a few seconds, then switch the device on again.
- ➔ The alarm message is deactivated.
- 4. Close the bath opening.
- ✓ The low liquid level safety function has been tested for functionality.

## 9.4 Replace detachable power cord

The device is equipped with a detachable power cord.

The unit may only be operated with the included power cable. If the power cable needs to be replaced due to a defect, it can be reordered.

Order number	Description
7.901.2655	Power cable EU, 200-230 V
7.901.2701	Power cable CH, 200-230 V
7.901.2665	Power cable CN, 230 V

## 9.5 Check and replace fuse

If the device can no longer be switched on, a defective fuse may be the cause.

✂ Slotted screwdriver, size 3

- ▶ The device is switched off and cooled to room temperature.
- 1. Disconnect the power supply cable.

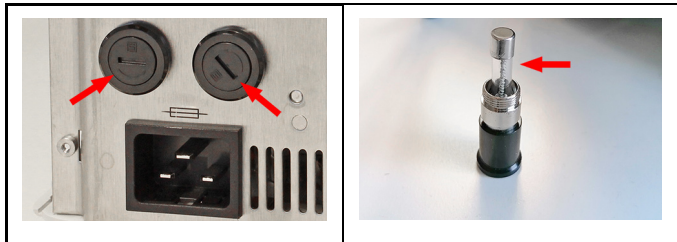

- 2. Use a flat screwdriver to unscrew the fuse holders [arrows image left].
- 3. Check the fuses [arrow image right].
- 4. Replace a defective fuse.

- ☞ See technical data for fuse type.
- 5. Mount the fuse holders using tested or replacement fuses.
- 6. Finally, perform a function test. If the device cannot be switched on even with new fuses, contact Technical Service.
- ✓ The fuses have been checked and replaced.

## 9.6 Emptying

The device must be completely drained if it is to be sent in for technical service or is to be properly disposed of.

In general, the device should be completely emptied before longer shutdowns or when there is a change to the external application.

	<b>CAUTION</b>
	<p><b>Risk of burns from hot bath fluid!</b></p> <p>Bath fluid can become very hot during a temperature control process. Contact with hot bath fluid can cause scalding.</p> <ul style="list-style-type: none"> <li>• Before draining the device, let it cool to room temperature</li> <li>• Avoid direct contact with hot bath fluid</li> <li>• Wear protective gloves</li> </ul>

- ▶ The device is tempered to room temperature and switched off.
- 1. Place an adequately large collection vessel under the drainage valve.
- 2. Take off the bath lid.
- 3. Open the drain valve.
- ↳ The bath fluid drains out of the bath tank into the collection vessel provided.
- 4. Once the bath tank is completely drained, close the bath opening.
- 5. Close the drain valve.
- ✓ The device is emptied. If an external system is connected, it can now be disconnected from the device and also drained.

## 9.7 Clean device

The circulator and bath tank, and also a cooling machine if connected, should be cleaned from time to time.

In addition to this, the device must be appropriately decontaminated if hazardous substances have been spilled on or into the device.

- ✘ Lint-free cloth
- ✘ Mild cleaning agent



**NOTE**

**Damage to the electronics due to water penetration!**

Ingress of water can damage electronic components of the device and thus lead to failure of the device.

- Clean the outside of the device with a damp cloth only
- Prevent water from entering the device

- ▶ The device is switched off and disconnected from the mains voltage.
  1. Allow the device to cool down to room temperature.
  2. Completely drain the bath fluid.
  3. Clean the surface of the circulator and the bath tank with a damp cloth.
- ☞ Some dish detergent may also be used for cleaning. If in doubt, ask technical service for alternative cleaning mediums.
- ✓ The device has now been cleaned.

## 9.8 Device storage

---

This section describes how to store the device.

- ▶ The device is switched off and disconnected from the mains voltage.
  1. Empty all system components completely.
  2. Clean the device.
  3. Carefully dry the device and all its system components, e.g. with compressed air.
  4. Close all connections.
  5. Store the device in a dust-free, dry and frost-free location.
- ✓ The device is protected and can be safely stored there. It can be put into operation again as needed.



---

## 9.9 Technical Service

---

If the unit shows faults you cannot resolve, please contact our Technical Service.

JULABO Technical Service

Tel.: +1(610) 231-0250 Option 3

Fax: +1(610) 231-260

Email: Service@julabo.us

Before sending a device to Technical Service, the following points must be observed:

- Clean and decontaminate the device properly to avoid endangering service personnel.
- Include a brief description of the fault.
- Package the device safely for shipment.

---

## 9.10 Warranty

---

The following Warranty Provisions shall apply to products sold in North America by Julabo ("Seller") to the entity shown as buyer ("Buyer") on Seller's invoice.

### **Initial Warranty**

Upon Seller's receipt of payment in full for the products and subject to Buyer's compliance with the terms of sale and any other agreement with Seller relating to the products, Seller warrants to the Buyer that the products manufactured by the Seller are free from defects in material and workmanship for a period not to exceed two (2) years of operation from the date the product is shipped by Seller to Buyer (the "Initial Warranty").

EXCLUSION OF ALL OTHER EXPRESS WARRANTIES; EXCLUSION OF ALL IMPLIED WARRANTIES.

OTHER THAN THE INITIAL WARRANTY, NO OTHER EXPRESS WARRANTIES ARE MADE. ALL IMPLIED WARRANTIES OF EVERY TYPE AND KIND, INCLUDING BUT NOT LIMITED TO ANY IMPLIED WARRANTY OF MERCHANTABILITY OR FITNESS FOR A PARTICULAR PURPOSE OR USE, ARE EXCLUDED IN ALL RESPECTS AND FOR ALL PURPOSES. SELLER DISCLAIMS AND MAKES NO IMPLIED WARRANTIES WHATSOEVER.

### **Exclusions**

The Initial Warranty does not include damage to the product resulting from accident, misuse, improper installation or operation, unauthorized or improper repair, replacement or alteration (including but not limited to repairs, replacements, or alterations made or performed by persons other than Seller's employees or authorized representatives), failure to provide (or use of improper) maintenance, unreasonable or unintended use or abuse of the product, or failure to follow written installation or operating instructions.

Buyer must return the product's record of purchase to the Seller or one of Seller's authorized representatives within thirty (30) days of the date the product is shipped by Seller to Buyer in order to make a claim under the Initial Warranty. Notwithstanding anything contained herein to the contrary, all glassware, including but not limited to reference thermometers, are expressly excluded from the Initial Warranty.

### **Buyer's sole remedies; Limitations on Seller's Liability**

Buyer's sole and exclusive remedy under the Initial Warranty is strictly limited, in Seller's sole discretion, to either: (i) repairing defective parts; or (ii) replacing defective parts. In either case, the warranty period for the product receiving a repaired or replaced part pursuant to the terms of the Initial Warranty shall not be extended. All repairs or replacements performed by Seller pursuant to these Warranty Provisions shall be performed at one of the Seller's facility in Allentown, Pennsylvania, U.S.A. or at the facility of an authorized representative of Seller, which location shall be determined by Seller in its sole discretion; provided, however, that Seller may, in its sole discretion perform such repairs or replacements at Buyer's facility in which case Buyer shall pay Seller's travel, living and related expenses incurred by Seller in performing the repairs or replacements at Buyer's facility. As a condition precedent to Seller's obligation to repair or replace a product part under the Initial Warranty, Buyer shall (i) promptly notify Seller in writing of any such defect; (ii) shall have returned the product's record of purchase to Seller or to Seller's authorized representatives within thirty (30) days of the date the product is shipped by the seller; and (iii) assist Seller in all respects in its attempts to determine the legitimacy and basis of any claims made by or on behalf of Buyer including but not limited to providing Seller with access to the product to check operating conditions. If Buyer does not provide such written notice to Seller within the Initial Warranty period or fails to return the product's record of purchase as set forth above, Seller shall have no further liability or obligation to Buyer therefor. In no event shall Seller's liability under the Initial Warranty exceed the original purchase price of the product which is the subject of the alleged defect.

THE REMEDIES PROVIDED IN THE INITIAL WARRANTY ARE THE SOLE AND EXCLUSIVE REMEDIES AVAILABLE TO THE BUYER. NOTWITHSTANDING ANYTHING TO THE CONTRARY CONTAINED HEREIN, AND EVEN IF THE SOLE AND EXCLUSIVE REMEDIES FAIL OF THEIR ESSENTIAL PURPOSE FOR ANY

REASON WHATSOEVER, IN NO EVENT SHALL SELLER BE LIABLE FOR BUYER'S MANUFACTURING COSTS, LOST PROFITS, GOODWILL, OR ANY OTHER SPECIAL, INDIRECT, PUNITIVE, INCIDENTAL OR CONSEQUENTIAL DAMAGES TO BUYER OR ANY THIRD PARTY AND ALL SUCH DAMAGES ARE HEREBY DISCLAIMED.

### **Assignment**

Buyer shall not assign any of its rights or obligations hereunder without the prior written approval of Seller; provided, however, that if Buyer is a distributor of Seller, the rights and obligations of Buyer under these Warranty Provisions shall inure to the benefit of and be binding upon Buyer's customers who provide the product's proof of purchase to Seller pursuant to the terms set forth herein. Seller may assign any or all of its rights or obligations hereunder without Buyer's prior consent.

### **Governing Law**

The Warranty Provisions and all questions relating to their validity, interpretation, performance, and enforcement shall be construed in accordance with, and shall be governed by, the substantive laws of the Commonwealth of Pennsylvania without regard to its principles of conflicts of law.

### **Waiver**

Any failure of the part of Seller to insist on strict compliance with the Warranty Provisions shall no way constitute a waiver of such right. No claim or rights arising out of a breach of the Warranty Provisions by Buyer may be discharged in whole or in part by a waiver of the claim or right, unless the waiver is in writing signed by an authorized representative of Seller. Seller's waiver or acceptance of any breach by Buyer of any provisions of the Warranty Provisions shall not constitute a waiver of or an excuse for nonperformance as to any other provision of the Warranty Provisions nor as to any prior or subsequent breach of the same provision.

### **Freight**

Seller will arrange and pay for shipping and handling for the return of the unit to the Buyer.

### **Out of Box Failure (OBF)**

An Out of Box Failure (OBF) is defined as a product failure immediately following unpacking and installation of a newly delivered product. JULABO provides a 14-day grace period after the date of shipment, during which time the delivered product must be checked for defect. The same exclusions that apply to the regular warranty also apply to OBF classification. For example, JULABO will not be liable for transport damage, damage inflicted by the customer or any other party, or defects arising from improper installation or usage.

## 10 Disposal

### 10.1 Device disposal

---

When disposing of the device, the applicable country-specific guidelines must be observed.

1. Completely drain the unit.
2. Contact an authorized waste disposal company for disposal of the unit.
  - ⚠ Disposal of the unit in household waste, or similar facilities for the collection of domestic waste, is not permissible.
  - ✓ The unit can be properly disposed of.

## 11 Appendix

### 11.1 Interface commands

Interface commands allow the device to be remote controlled. Parameters can be retrieved and the current status can be queried. To do this, the device must be connected to the master computer via a digital interface. Interface commands are entered using a terminal program.

Interface commands are divided into IN commands and OUT commands.

String element	Symbol	Hex
Space	␣	20
Carriage return	↵	0D
Line feed	LF	0A

- IN commands: Retrieve parameters  
Command structure: Command + ↵  
  
ex. Querying the setpoint temperature:  
IN\_SP\_00↵ (RS485: A032\_IN\_SP\_00↵)  
  
Example: Device response:  
55.5 ↵LF  
(RS485: A032\_55.5 ↵LF)
- OUT commands: Set parameters (only in remote control mode)  
Command structure: Command + ␣ + parameter + ↵  
  
ex. Set the setpoint temperature to 55.5 °C:  
OUT\_SP\_00\_55.5↵ (RS485: A032\_OUT\_SP\_00\_55.5↵)

When working with the RS485 interface, each command is preceded by the three-digit device address, e. g. address Ad32 = A032.

### 11.1.1 IN commands

IN commands retrieve device parameters.

Process values	System response
in_pv_00	Actual value
in_pv_01	Current variable (%)
In_pv_02	Current temperature of the external Pt100 temperature sensor
in_pv_03	Current temperature of the temperature safety sensor
in_pv_04	Current setting of the high temperature safety function
in_pv_06	Current pressure. EPROG input must be set to pressure
in_pv_07	Current flow. EPROG input must be set to flow
in_pv_16	Current bath fluid filling level (%)

Process values	System response
in_pv_15	Query external actual temperature

Setpoints and warning limits	System response
in_sp_00	Set setpoint temperature
in_sp_03	Set high temperature warning limit
in_sp_04	Set low temperature warning limit
in_sp_05	Set working temperature via EPROG
in_sp_06	Setpoint temperature set via watchdog function
in_sp_07	Set pump stage (1 ... 4)
in_sp_10	Set actuating variable specification via serial interface
in_sp_11	Set temperature unit 0 = °C 1 = °F
in_sp_12	Set pressure unit: 0 = bar 1 = psi
in_sp_13	Set flow unit:

	0 = l/min 1 = gpm
in_sp_27	Set pump setting
in_sp_28	High temperature alarm limit
in_sp_29	Low temperature alarm limit

<b>Unit modes</b>	<b>System response</b>
in_mode_01	Return value 0. The value 0 stands for the control temperature setpoint as only one temperature setpoint can be set (downward compatibility for older units)
in_mode_02	Selftune: 0 = Selftune disabled 2 = Selftune enabled
in_mode_03	Operating mode setting for the EPROG input: 0 = 0 ... 10 V 1 = 4 ... 20 mA
in_mode_04	Operating mode setting for the temperature control: 0 = Internal 1 = External
in_mode_05	Operating mode set for the temperature control system: 0 = Stop 1 = Start
in_mode_08	Controller dynamics set with internal temperature control: 0 = Aperiodic 1 = Default
in_mode_11	Actuating variable source: 0 = Thermostat 1 = Serial 2 = Analog (EPROG)
In_mode_12	Set actual temperature source: 0 = Pt100 (thermostat) 1 = Serial 2 = USB 3 = Ethernet 4 = Modbus 5 = OPCUA 20 = EPROG

<b>IN PAR</b>	<b>System response</b>
in_par_00	Set sensor difference between working temperature sensor and safety temperature sensor
in_par_01	Set time constant of the external bath TE
in_par_02	Set internal gradient value SI
in_par_03	Set time constant of the internal bath TI
in_par_04	Set optimization parameter CoSpeed
in_par_05	Ration of cooling/heating capacity pk to ph
in_par_06	Set control parameter Xp of the internal controller
in_par_07	Set control parameter Tn of the internal controller
in_par_08	Set control parameter Tv of the internal controller
in_par_09	Set control parameter Xp of the cascade-controller
in_par_10	Set control parameter Xpu of the subordinate controller (cascade temperature control)
in_par_11	Set control parameter Tn of the cascade-controller
in_par_12	Set control parameter Tv of the cascade-controller
in_par_13	Set maximum permissible internal temperature InternMax in cascade temperature control
in_par_14	Set minimum permissible internal temperature InternMin for cascade temperature control
in_par_15	Set band limit upper in cascade temperature control
in_par_16	Set band limit lower in cascade temperature control

<b>Auxiliary parameters</b>	<b>System response</b>
in_hil_00	Set actuating variable limit for cooling capacity (%)
in_hil_01	Set actuating variable limit for heating capacity (%)

<b>ATC IN commands</b>	<b>Parameter</b>	<b>System response</b>
ATC:INT:STATUS?		Number of correction points used for internal adjustment.
ATC:INT:POINTx?	1 ... 10	Set values of the requested internal adjustment correction point.



		Example: ATC : INT : POINT1 ? Answer: 20.00 ; 20.01
ATC : EXT : STATUS ?		Number of correction points used for external adjustment.
ATC : EXT : POINTx ?	1 ... 10	Set values of the requested external adjustment correction point. Example: ATC : EXT : POINT1 ? Answer: 20.00 ; 20.01

### 11.1.2 OUT commands

OUT commands set device parameters. Remote control mode must be active.

Process values	System response
out_pv_15	Specifying the external actual temperature

Parameter settings	Parameter	Setting
out_sp_00	xxx.xx	Setting for the setpoint temperature
out_sp_03	xxx.xx	Setting for the high temperature
out_sp_04	xxx.xx	Setting for the low temperature
out_sp_06	xxx.xx	Setpoint temperature setting via watchdog function
out_sp_07*	x	Set pump to preset levels 1...4: 1 = 55 %, 2 = 65 %, 3 = 75 %, 4 = 85 %
out_sp_10	xxx.xx	Setting for the actuating variable via the serial interface
out_sp_11	x	Setting the temperature units: 0 = °C 1 = °F
out_sp_12	x	Setting the pressure unit: 0 = bar 1 = psi
out_sp_13	x	Adjusting the flow unit: 0 = l/min 1 = gpm

out_sp_27	xxx	Pump capacity in %
out_sp_28	xxx.xx	High temperature alarm limit setting
out_sp_29	xxx.xx	Low temperature alarm limit setting

\* Do not use for reprogramming, use out\_sp\_27 instead. Pump stage 4 has an output pressure of approx. 450 mbar.

Unit modes	Parameter	Setting
out_mode_01	x	Setting 0 (the parameter 1 or 2 can also be used for downwards compatibility. Within the unit it has no effect)
out_mode_02	x	Selftune: 0 = Selftune disabled 2 = Selftune enabled
out_mode_03	x	Setting of the operating mode EPROG: 0 = 0-10 V 1 = 0-20 mA
out_mode_04	x	Setting of the temperature control: 0 = Internal control 1 = External control
out_mode_05	x	Start/stop command of the unit in remote control mode: 0 = stop tempering 1 = start tempering
out_mode_08	x	Setting of the internal control dynamic: 0 = Aperiodic 1 = Default
out_mode_11	x	Actuating variable source: 0 = Thermostat 1 = Serial 2 = Analog (EPROG)
out_mode_12	x	Actual temperature source: 0 = Pt100 1 = Serial 2 = USB 3 = Erthernet 4 = Modbus 5 = OPCUA 20 = EPROG

<b>System parameter</b>	<b>Parameter</b>	<b>Setting</b>
out_par_04	xxx	Setting the Cospeed control parameter for internal control
out_par_06	xxx	Setting of the control parameter XP for internal control
out_par_07	xxx	Setting of the control parameter TN for internal control
out_par_08	xxx	Setting of the control parameter TV for internal control
out_par_09	xxx	Setting of the control parameter XP of the subordinate controller (cascade temperature control)
out_par_10	xxx	Setting of the control parameter XPU of the subordinate controller (cascade temperature control)
out_par_11	xxx	Setting of the control parameter TN of the subordinate controller (cascade temperature control)
out_par_12	xxx	Setting of the control parameter TV of the subordinate controller (cascade temperature control)
out_par_13	xxx	Setting of the maximum permissible internal temperature InternMax in cascade temperature control
out_par_14	xxx	Setting of the minimum required temperature InternMin in cascade temperature control
out_par_15	xxx	Setting of the band limit upper in cascade temperature control
out_par_16	xxx	Setting of the band limit lower in cascade temperature control

<b>Auxiliary parameters</b>	<b>Parameter</b>	<b>Setting</b>
out_hil_00	-xxx	Setting of the actuating variable limit for cooling capacity (0-100%)
out_hil_01	xxx	Setting of the actuating variable limit for heating capacity (0-100%)

ATC OUT command	Parameter	Setting
ATC:INT:STATUS	1 ... 10	Sets the number of correction points used for internal adjustment. 0 = ATC_OFF Example: ATC:INT:STATUS_1 A correction point is used.
ATC:INT:POINTx _YY.YY;ZZ.ZZ	x = 1 ... 10 yy.yy = circulator temperature zz.zz = correction value	Example: Command: ATC:INT:POINT1_20.00;20.10 Defines correction point 1 for internal adjustment, with circulator temperature = 20.00 °C and correction value = 20.01 °C.
ATC:EXT:STATUS	1 ... 10	Sets the number of correction points used for external adjustment. 0 = ATC_OFF Example: ATC:EXT:STATUS_1 A correction point is used.
ATC:EXT:POINTx _YY.YY;ZZ.ZZ	x = 1 ... 10 yy.yy = circulator temperature zz.zz = correction value	Example: Command: ATC:EXT:POINT1_20.00;20.10 Defines correction point 1, with circulator temperature = 20.00 °C and correction value = 20.01 °C.

### 11.1.3 Status commands

Status commands are used to query the current status of the device.

Status commands	System response
version	Current firmware version
status	Return of status, error, warning, alarm

### 11.1.4 Status messages

Possible status messages from the device for a status query.

Status message	Explanation
00 MANUAL STOP	Device in standby mode manual operation
01 MANUAL START	Device in manual mode

02 REMOTE STOP	Device in standby mode, remote control operation
03 REMOTE START	Device in remote control mode
-08 INVALID COMMAND	Device did not recognize the last received command
-09 COMMAND NOT ALLOWED IN CURRENT OPERATING MODE	Last received command is not permissible in the operating mode
-10 VALUE TOO SMALL	The last set value is too small
-11 VALUE TOO LARGE	The last set value is too large
-13 VALUE EXCEEDS TEMPERATURE LIMITS	The value is not within the set temperature limits

## 11.2 Alarms and Warnings

If the device is connected to a network and remotely controlled, a status query via interface command will lead to any alarms or warnings that are present being output as a string.

- The maximum output string length for alarms and warnings is 22 characters
- String structure:
  - 01 ALARM: xxxxxxxx
  - 01 WARNING: xxxxxxxx
- The preceding error code, e.g. -01, is described in the table

If a displayed error code is not described in the table or the error is still pending after switching off and on again, please contact Technical Service.

The listed error codes can occur depending on the device type and version.

-01	The unit is being operated with a bath fluid level that is too low.	<ul style="list-style-type: none"> <li>• Top up the bath fluid.</li> <li>• Check the temperature control hoses for damage and replace if necessary.</li> </ul>
-03	The measured temperature is over the set high temperature limit.	<ul style="list-style-type: none"> <li>• Increase "high temperature" temperature limit or decrease temperature setpoint.</li> </ul>
-04	The measured temperature is below the set low temperature limit.	<ul style="list-style-type: none"> <li>• Reduce "low temperature" temperature limit or increase temperature setpoint.</li> </ul>

-05	The cable for the working temperature sensor has broken or short-circuited.	<ul style="list-style-type: none"><li>• Contact Technical Service.</li></ul>
-06	The temperature difference between the working temperature sensor and the safety temperature sensor is too large.	<ul style="list-style-type: none"><li>• Increase circulation.</li><li>• Check the viscosity of the tempering fluid.</li><li>• If the fault has not been remedied, contact Technical Service.</li></ul>
-14	The set protective temperature has been exceeded.	<ul style="list-style-type: none"><li>• Check working temperature range of the application.</li><li>• Increase the value of the protective temperature or decrease the setpoint temperature until it is lower than the set protective temperature.</li></ul>
-15	The line of the external temperature sensor has short circuited or been interrupted.	<ul style="list-style-type: none"><li>• Check electrical connection to external temperature sensor.</li></ul>
-38	The setpoint value is set to external temperature sensor, but no signal is available.	<ul style="list-style-type: none"><li>• Check whether an external temperature sensor is connected or whether the electrical connection is interrupted.</li><li>• If necessary, adjust the setpoint value.</li></ul>
-40	The early warning system for low liquid level reports a critical fluid level.	<ul style="list-style-type: none"><li>• Top up the bath fluid.</li></ul>
-41	The early warning system for high liquid level reports a critical fluid level.	<ul style="list-style-type: none"><li>• Drain the bath fluid.</li></ul>
-47	A current is measured even though heating is not required.	<ul style="list-style-type: none"><li>• Disconnect the unit from the power supply.</li><li>• Contact Technical Service.</li></ul>
-59	The measured temperature of the heat sink in the control section of the Booster Heater has exceeded the alarm limit. The Booster Heater is switched off.	<ul style="list-style-type: none"><li>• Check ambient temperature and reduce if necessary.</li><li>• Check the ventilation openings on the control section of the Booster Heater for contamination and, if necessary, clean them.</li><li>• If the fault has not been remedied, contact Technical Service.</li></ul>

-60	Internal read/write error.	<ul style="list-style-type: none"> <li>Switch off the unit at the mains switch, wait 4 seconds and then switch the unit on again.</li> </ul>
-61	CAN bus error	<ul style="list-style-type: none"> <li>Check CAN bus cable for damage and replace as necessary. Switch the unit on again. If the fault has not been remedied, contact Technical Service.</li> <li>Alternatively: Deactivate the refrigeration unit. The circulator operates as a heater thermostat.</li> </ul>
-63	Watchdog function has responded.	<ul style="list-style-type: none"> <li>Switch off the unit at the mains switch, wait 4 seconds and then switch the unit on again.</li> </ul>
-83	Excessive power consumption via USB interface.	<ul style="list-style-type: none"> <li>Check inserted USB stick for defects and replace as necessary. The USB-A interface is not suitable for consumers with a higher required current than the maximum permissible current.</li> </ul>
-108	The alarm latch of the protective equipment is still active.	<ul style="list-style-type: none"> <li>Switch off the unit at the mains switch, wait 4 seconds and then switch the unit on again.</li> </ul>
-116	The alarm latch of the protective equipment is still active.	<ul style="list-style-type: none"> <li>Switch off the unit at the mains switch, wait 4 seconds and then switch the unit on again.</li> </ul>
-142	Unit started, actual value source of the external temperature set on display, reception timeout of the external temperature via CAN bus.	<ul style="list-style-type: none"> <li>Contact technical service.</li> </ul>
-143	The set temperature limit for overtemperature alarm was exceeded.	<ul style="list-style-type: none"> <li>Increase overtemperature alarm temperature limit or decrease setpoint temperature.</li> </ul>
-144	The set temperature limit for subtemperature alarm was exceeded.	<ul style="list-style-type: none"> <li>Decrease temperature limit of subtemperature alarm or increase temperature setpoint.</li> </ul>

-159	The measured temperature of the heat sink in the control section of the Booster Heater has exceeded the warning limit. The heating capacity of the Booster Heater is reduced.	<ul style="list-style-type: none"><li>• Check ambient temperature and reduce if necessary.</li><li>• Check the ventilation openings on the control section of the Booster Heater for contamination and, if necessary, clean them.</li><li>• If the fault has not been remedied, contact Technical Service.</li></ul>
-502	Error communicating with a WLAN stick when using remote control. WLAN stick has been removed or lost connection.	<ul style="list-style-type: none"><li>• The WLAN stick has been deactivated. Please reconnect the WLAN stick or switch the remote control.</li></ul>
-503	External setpoint value is set via EPROG, but no analog module is connected.	<ul style="list-style-type: none"><li>• Connect analog module or deactivate external setpoint specification using EPROG.</li></ul>
-504	External actuating variable is set via EPROG, but no analog module is connected.	<ul style="list-style-type: none"><li>• Connect analog module or deactivate external actuating variable using EPROG.</li></ul>
-505	The analog module transmits an invalid setpoint.	<ul style="list-style-type: none"><li>• Check EPROG settings.</li></ul>
-1109	Viscosity of the bath fluid too high or the circulation rate too low.	<ul style="list-style-type: none"><li>• Check the temperature of the bath fluid to ensure it is within the desired temperature range.</li></ul>
-1305	The rotational speed limit for the heating capacity block is not reached. Motor defective or fluid viscosity too high.	<ul style="list-style-type: none"><li>• Check pump setting and adjust if necessary.</li><li>• Check viscosity of the bath fluid and adjust if necessary.</li></ul>
-1501	Timeout on serial interface.	<ul style="list-style-type: none"><li>• If the Watchdog is activated, check whether the temperature setpoint is sent to the unit cyclically at least every 30 seconds.</li></ul>



## 11.3 Modbus TCP/IP register

### 11.3.1 Data type

The Modbus protocol uses 16-bit registers for data transmission. Data that use more than 16 bits must be divided into several registers. For values that are divided into several registers, the registers are arranged according to the Modbus format. For error-free communication, all bus devices need to use the same format.

Float values are encoded in IEEE754 format (1 bit sign, 8 bit exponent, 23 bit mantissa).

The Modbus protocol uses the data types listed in the table.

Data type	Registers	Explanation
short	1	Signed 16-bit value
ushort	1	Unsigned 16-bit value
int	2	Signed 32-bit value
uint	2	Unsigned 32 bit value
float	2	Floating point number with 32 bit

### 11.3.2 Feedback on invalid entries

If the device receives an invalid data packet, it responds with an exception response. The following exceptions are recognized by the device.

Code	Name	Explanation
01	Illegal function	The received function code is not supported by the device. An attempt was made to set a value although the device is not in remote control mode.
02	Illegal data address	The received data address is not supported by the device. The combination of data address and data length is not supported by the device (e.g. only one register of a value that includes several registers). The register cannot be changed.
03	Illegal data value	The set value is outside the permitted value range.

### 11.3.3 Function codes

Name	Code (dec.)	Code (hex.)	Explanation
Read Holding Registers	03	03	Read several holding registers
Write Single Registers	06	06	Write a single holding register
Write Multiple Registers	16	10	Write several consecutive holding registers. This function can be used to set values that use more than one register.
Read/Write Multiple Registers	23	17	Combination of read and write operation
Read Input Register	04	04	

### 11.3.4 Holding registers

Register address	Protocol address	Data type	Explanation	Adjustable range
40001	0	ushort	Start/stop the unit	0: Unit is in standby 1: Unit is started
40002	1	ushort	Type of actuating variable	0: Controller 1: Digital 2: EPROG
40003-40004	2-3	float	Setpoint temperature	min. - max.
40005	4	short	Actuating variable via Modbus	-100 ... 100
40006	5	ushort	Actual temperature source	0: Pt100 (thermostat) 1: Serial 2: USB 3: Ethernet 4: Modbus 5: OPCUA 20: EPROG

40007 40008	6-7	float	External actual temperature	
<b>Control parameter</b>				
40011	10	ushort	Internal/external temperature control	0: Temperature control in the internal bath 1: Temperature control with external Pt100
40012	11	ushort	Set identification	0: No identification. The saved parameters are used for the regulation 1: Unique identification of the controlled process after the next start 2: Permanent identification of the controlled process after each start
40013- 40014	12-13	float	Xp control parameter of the internal controller.	0.1 ... 99.9 K
40015	14	ushort	Tn control parameter of the internal controller.	3 ... 9999 s
40016	15	ushort	Tv control parameter of the internal controller.	0 ... 999 s
40017	16	ushort	Control dynamics	0: Aperiodic 1: Standard
40018- 40019	17-18	float	Xp control parameter of the cascade-controller.	0.1 ... 99.9 K
40020	19	ushort	Tn control parameter of the cascade-controller.	3 ... 9999 s
40021	20	ushort	Tv control parameter of the cascade-controller.	0 ... 999 s
40022- 40023	21-22	float	P-proportion of the subordinate controller	0.1 ... 99.9 K
40024- 40025	23-24	float	CoSpeed control parameter of the external controller	0.0 ... 5.0

<b>Controller limitations</b>				
40041	40	short	Maximum desired cooling capacity	-100 ... 0
40042	41	short	Maximum desired heating capacity	0 ... 100
40043-40044	42-43	float	Minimum internal temperature with cascade temperature control	
40045-40046	44-45	float	Maximum internal temperature with cascade temperature control	
40047	46	short	Lower band limit	0 ... 200 K
40048	47	short	Upper band limit	0 ... 200 K
<b>Pump settings</b>				
40053	52	ushort	Pump capacity	40% ... PumpMax
<b>Temperature warning limits</b>				
40061-40062	60-61	float	Low temperature warning value	
40063-40064	62-63	float	High temperature warning value	
40112-40113	111-112	float	High temperature alarm value	
40114-40115	113-114	float	Low temperature alarm value	
<b>Setpoint limits</b>				
40071-40072	70-71	float	minimum adjustable temperature setpoint	
40073-40074	72-73	float	maximum adjustable temperature setpoint	
40075	74	ushort	maximum adjustable pump capacity	40-100%
<b>Units</b>				
40091	90	ushort	Temperature units	0: °C, 1: °F
40092	91	ushort	Pressure unit	0: bar, 1: psi
40093	92	ushort	Flow unit	0: l/min, 1: gpm

<b>Date/time</b>				
40101	100	ushort	Year	
40102	101	ushort	Month	
40103	102	ushort	Day	
40104	103	ushort	Hour	
40105	104	ushort	Minutes	
40106	105	ushort	Second	

<b>Register address</b>	<b>Protocol address</b>	<b>Data type</b>	<b>Explanation</b>	<b>Adjustable range</b>
40117	116	ushort	Start/stop the unit	0: Unit is in standby 1: Unit is started

### 11.3.5 Input register

<b>Register address</b>	<b>Protocol address</b>	<b>Data type</b>	<b>Explanation</b>	<b>Value range</b>
30001-30002	0-1	uint	Firmware version	Byte1: Major Byte2: Minor Byte3: Build Byte4: Revision
30004-30005	3-4	uint	Barcode	
30006	5	short	Remote control mode	
30007	6	short	Alarm code	
30008	7	short	Warning code	
30011-30012	10-11	float	Bath temperature	
30013-30014	12-13	float	Temperature value of the external Pt100 temperature sensor	
30015	14	short	Present heating capacity (%)	-100 ... 100
30016-30017	15-16	float	Safety sensor temperature value	

---

30042	41	short	Current bath fluid filling level (%)	0 ... 100
30051-30052	50-51	float	Si - Gradient of the internal bath	
30053	52	ushort	Ti - Time constant of the internal bath	
30054	53	ushort	Te - Time constant of the external bath	



