



# FC-i Series

---

## INSTRUCTION MANUAL

---

### Counting Scale



FC-50Ki  
FC-20Ki  
FC-10Ki  
FC-5000i

The logo for A&D Company, Limited, featuring the letters 'A' and 'D' in a bold, stylized font with a thick, black outline. The 'A' and 'D' are connected at the top and bottom, with an ampersand symbol between them.

A&D Company, Limited

## This manual and Marks

All safety messages are identified by the following, "WARNING" or "CAUTION", of ANSI Z535.4 (American National Standard Institute: Product Safety Signs and Labels). The meanings are as follows:

 WARNING	A potentially hazardous situation which, if not avoided, could result in death or serious injury.
 CAUTION	A potentially hazardous situation which, if not avoided, may result in minor or moderate injury.



This is a hazard alert mark.



This mark informs you about the operation of the product.



The information mark of another operations.

**Note** This manual is subject to change without notice at any time to improve the product. No part of this manual may be photocopied, reproduced, or translated into another language without the prior written consent of the A&D Company.

Product specifications are subject to change without any obligation on the part of the manufacture.

## Compliance with FCC rules

Please note that this equipment generates, uses and can radiate radio frequency energy. This equipment has been tested and has been found to comply with the limits of a Class A computing device pursuant to Subpart J of Part 15 of FCC rules. These rules are designed to provide reasonable protection against interference when this equipment is operated in a commercial environment. If this unit is operated in a residential area it might cause some interference and under these circumstances the user would be required to take, at his own expense, whatever measures are necessary to eliminate the interference.

(FCC = Federal Communications Commission in the U.S.A.)

Copyright©2003 A&D Company, Limited

---

# Contents

---

<b>1. INTRODUCTION.....</b>	<b>3</b>
1-1. Unpacking.....	3
1-2. Setting Up Your Scale.....	3
1-3. Standby and Operating Mode.....	5
1-4. Simple Operation Mode.....	5
1-5. kg or lb Weighing Units.....	5
1-6. Last Unit Weight Used Feature.....	6
<b>Front Panel Overview.....</b>	<b>7</b>
<b>2. BASIC OPERATIONS.....</b>	<b>8</b>
2-1. Basic Operations.....	8
2-2. To Start Counting.....	10
2-3. Unit Weight By Samples.....	11
2-4. Unit Weight By KEYBOARD.....	15
2-5. Unit Weight By ID Number.....	16
<b>3. ENTERING A TARE WEIGHT.....</b>	<b>17</b>
3-1. Using the KEYBOARD TARE Key.....	17
3-2. To Clear TARE.....	18
<b>4. STORE UNIT WEIGHT.....</b>	<b>19</b>
4-1. Store Unit Weight by ID Numbers.....	19
4-2. Clearing A Stored Unit Weight.....	20
4-3. Store Item Code by ID Number.....	21
4-4. Unit Weight, Tare, Comparator Limits & Total Count Stored.....	23
<b>5. USING THE M+ MEMORY.....</b>	<b>24</b>
5-1. The M+ Memory Function.....	24
5-2. Viewing the M+ Total.....	25
5-3. Clearing the M+ Total.....	25
5-4. The M- Function.....	25
<b>6. COMPARATOR FUNCTION.....</b>	<b>26</b>
<b>7. TIME AND DATE FUNCTION.....</b>	<b>28</b>
<b>8. CALIBRATION.....</b>	<b>29</b>
8-1. Calibration Procedure Using a Weight.....	29
8-2. Gravity Compensation.....	31
<b>9. F-FUNCTION PARAMETERS.....</b>	<b>32</b>
9-1. To Change or View F-Function Settings.....	32
9-2. F-Functions.....	33
<b>10. ACAI FUNCTION.....</b>	<b>40</b>
10-1. ACAI Automatic Counting Accuracy Improvement.....	40

10-2. ACAI Automatic Operation .....	40
10-3. ACAI Manual Operation .....	41
<b>11. RS-232C SERIAL INTERFACE .....</b>	<b>42</b>
11-1. RS-232C Specifications .....	42
11-2. Data Output Mode .....	43
11-3. Connecting the AD-8121 Printer / MODE 1 or MODE 2 .....	44
11-4. Connecting the AD-8121 Printer / MODE 3 .....	44
11-5. Command Mode.....	45
<b>12. OPTIONS .....</b>	<b>51</b>
12-1. OP-02 Ni-MH Battery Pack .....	51
12-2. OP-03 2 Ch. RS-232C .....	52
12-3. OP-04 RS-232C and Comparator Relay Output .....	53
12-4. OP-05 Remote Scale Interface .....	54
<b>13. SPECIFICATIONS .....</b>	<b>58</b>
<b>14. GRAVITY ACCELERATION MAP .....</b>	<b>59</b>

# 1. INTRODUCTION

## 1-1. Unpacking

- ❑ Unpack the scale carefully and keep the packing material if you are likely to transport the scale again in the future.
- ❑ In the carton you should find this manual plus:
  - The counting scale.
  - An AC adapter (check that the AC input rating is correct).

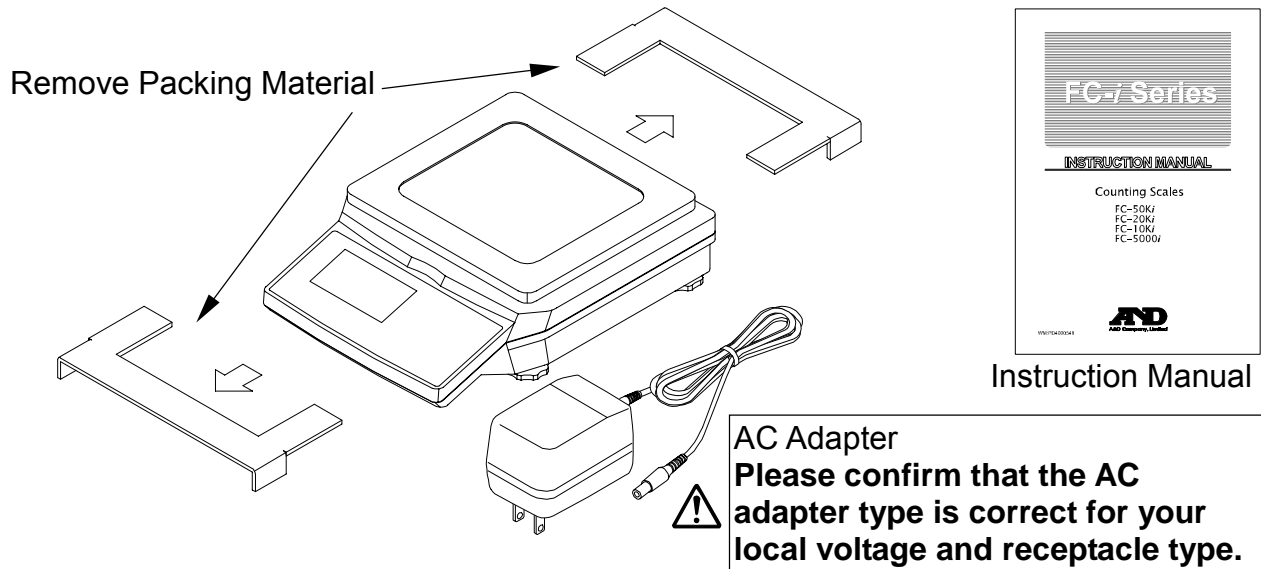

Remove the protective packing materials from around the scale and between the pan and scale casing.

## 1-2. Setting Up Your Scale

1. Place the scale on a suitable weighing surface (Refer to **Best Conditions For Weighing** of next page) and turn the adjustable feet until the spirit level shows that the scale is level.
2. Plug in the AC adapter. The AC input requirements could be 100, 120, 220, 230 or 240 Volts (50/60Hz) depending on where used, so, please check that the adapter is correct. Ground the scale to avoid a problem of the static electricity.

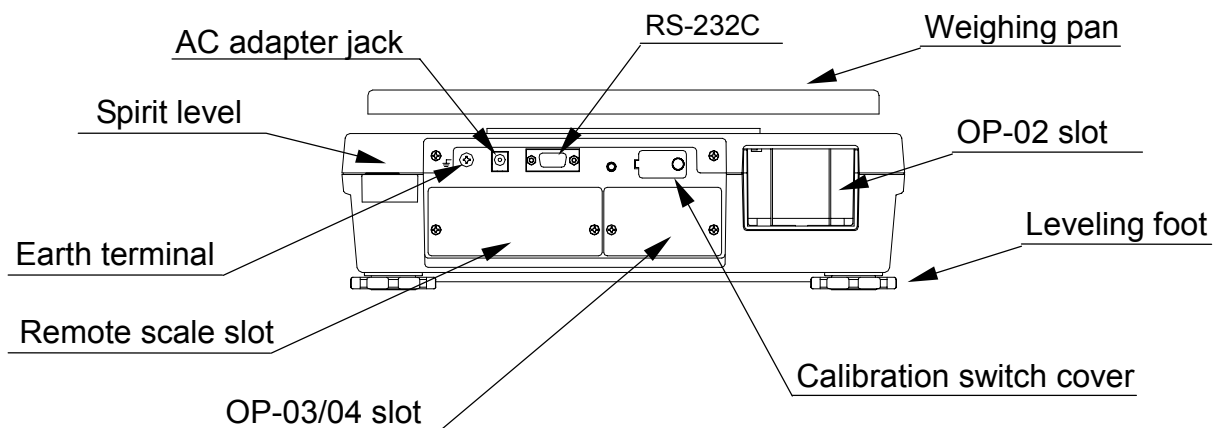

- The display comes ON

After running through a self-check that will show various segments, the weighing display will appear.

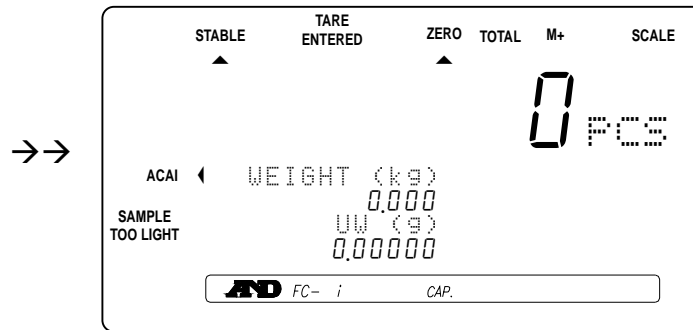
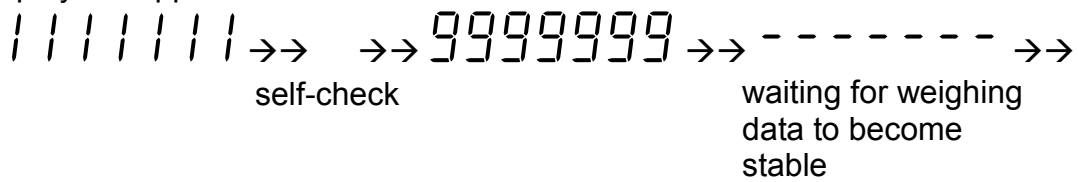

- Please leave the scale for at least thirty minutes with the AC adapter that is connected before use. We call this situation "warm-up".  
If desired: press the **STANDBY/OPERATE** key to turn the display off.  
Remember that the scale will always be warmed up as long as the AC adapter is connected. This keeps the scale always ready for use.

## Best Conditions For Weighing

- The scale must be level (check the spirit level on the scale).
- Best operating temperature is between 20°C~25°C / 68°F~77°F at about 50%~60% relative humidity. There shouldn't be large temperature fluctuations.
- The weighing room should be kept clean and dry.
- The weighing table must be of a solid construction.
- Corners of rooms are best as they are less prone to vibrations.
- Don't install the scale near heaters or air conditioners.
- Don't install the scale in direct sunshine.
- Try to ensure a stable AC power supply when using the AC adapter.
- Keep equipment containing magnets away from the scale.
- Warm up the scale before use or leave it on standby overnight.
- Ground the scale chassis for electrostatic discharge if the weighing conditions warrant.

## Calibration

Calibration of the FC-i scales is required when the scale is initially installed, or if a remote scale is added. Please refer to "8. CALIBRATION" for more calibration information.

### 1-3. Standby and Operating Mode

The FC-*i* scale has two principal modes: Standby mode and operating mode.

**Standby mode:** When the scale has power supplied to it, either by the AC Adapter or the battery pack, and the display is not indicate, the scale is in the standby mode.

In day-to-day operation, standby mode is normal when the scale is not in use.

This keeps the weighing mechanism warmed up.

**Operating mode:** If the display is turned on from standby mode, then the scale is in operating mode.

If the scale is not going to be used for a long period of time, then it may be appropriate to disconnect the main power.

- ❑ Use the STANDBY/OPERATE key to turn the display on or off. When the scale is in Standby mode, a period appears in the weight display as an indicator.

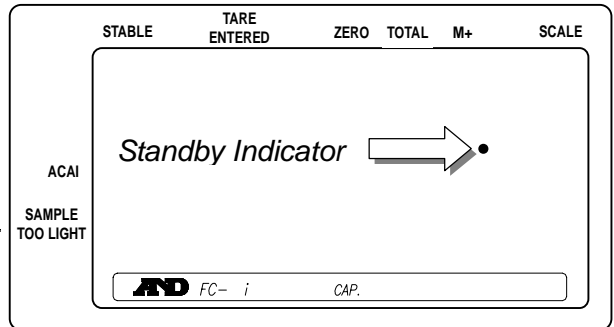
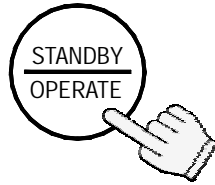

### 1-4. Simple Operation Mode

If desired, the FC-*i* scale can be set in a simple operation mode. In this mode, only front panel keys that would be used in “2-3. Unit Weight By a Sample” counting operations are active. All others will not operate. The following keys are active in simple operations mode:

**Keys that will operate in simple operation mode:**

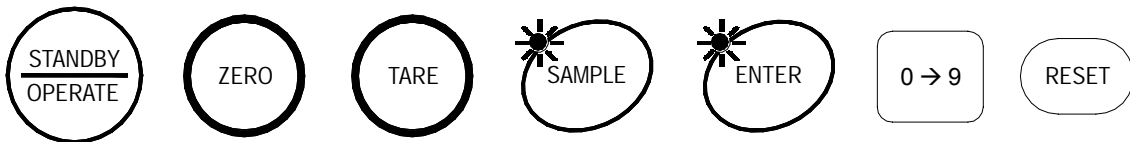

### 1-5. kg or lb Weighing Units

USA Version ONLY

The FC-*i* scale can weigh and register the unit weight in pounds or kilograms (it comes set to pounds "lb"). When you switch between the weighing units, the display will show the current weighing unit, and any weight amounts being used are also converted.

- ❑ To change the weighing units between pounds and kilograms, refer to F-Function F-00-01. Set at “0” for kg; or at “1” for lb.

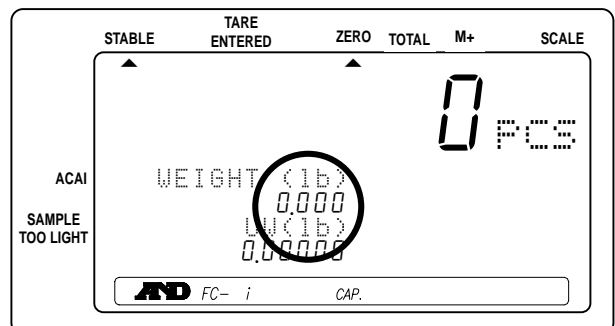

## 1-6. Last Unit Weight Used Feature

There are a number of ways to register a unit weight to count. The FC-*i* scale has a feature to keep the last unit weight used in memory. This can be handy if you turn the scale display off and then want to return to the same unit weight, or you accidentally clear the unit weight by pressing the **RESET** key.

When a unit weight is registered it is automatically placed in the ID “*id-000000*” and remains there until a new unit weight is entered, or the power is disconnected. It can be recalled by the following:

1. When the three **UNIT WEIGHT BY** LED's are blinking at display ON, or if the **RESET** key has been pressed;

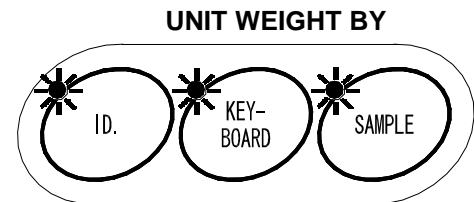

2. Press the **ID** key.  
 “*id-000000*” will be displayed with  $\geq 000000 \leq$  blinking.

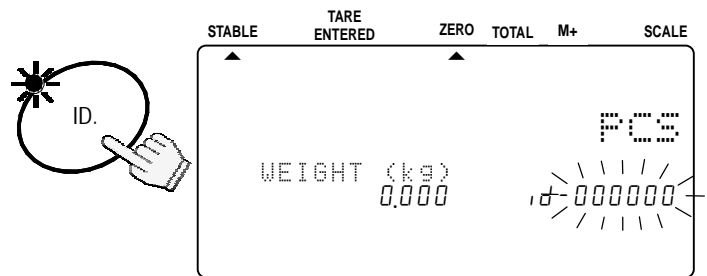

3. Press the **ENTER** key.  
 The scale will recall the previous unit weight.

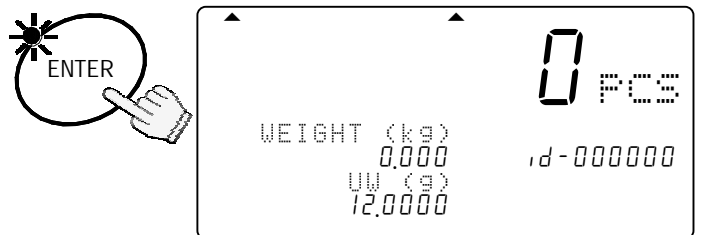

### Automatic Last Unit Weight Used

When you turn the display on, the scale can automatically recall the last unit weight used from memory, if desired.

- Set the F-Function *F-01-04* at “1”. The scale will recall the last unit weight used, when the display is turned ON.



# Front Panel Overview

The **▲ TARE ENTERED** indicator comes on when the tare weight is subtracted.

The **▲ TOTAL** indicator comes on when the count display is showing the total value.

**SCALE**  
1: main scale is used.  
2: remote scale is used.

The **[REMOTE SCALE]** key switches between the main and a remote scale (if used).

The **[TOTAL]** key displays the accumulated data on the count display and also back again.

The **[\*]** key displays comparator limits and time & date, or works as **[M-]** key.

The **▲ STABLE** indicator comes on when the weighing data is stable.

The **▲ ZERO** indicator comes on when the scale is at the center of zero.

The **▲ M+** indicator comes on when Count data is being accumulated.

The **[PRINT]** key sends count, weight or unit weight data.

The **[M+]** key accumulates the count data.

The **[RESET]** key clears the Unit Weight data in memory (but not in ID memory).

Count (pcs) display.

Comparator results.

Weight display.

The **◀ ACAI** indicator comes on when weight is within the ACAI range. When meeting the ACAI addition range, it will blink.

The **◀ SAMPLE TOO LIGHT** indicator comes on when the unit weight is too light.

Unit weight display.

The **[STANDBY/OPERATE]** key turns the display on and off.

The **[KEYBOARD TARE]** key allows entering a known tare weight from the 10-key pad.

ID number display (6 digit).

Item code stored in the ID memory (12 digit).

The **[STORE UNIT WEIGHT]** key stores the unit weight on display, item code data to ID memory.

The **[ID]** key is used when recalling unit weight data from ID memory.

The **[ENTER]** key enters unit weight, sample size, ID or other data into the scale from the 10-key pad.

The **[0] ~ [9] & [.]** 10-keys send numbers to the display.

The **[C]** key clears the display 10-key input.

The **[SAMPLE]** key is used when entering sample size.

The **[KEYBOARD]** key is used when unit weight is to be entered via the 10-key pad.

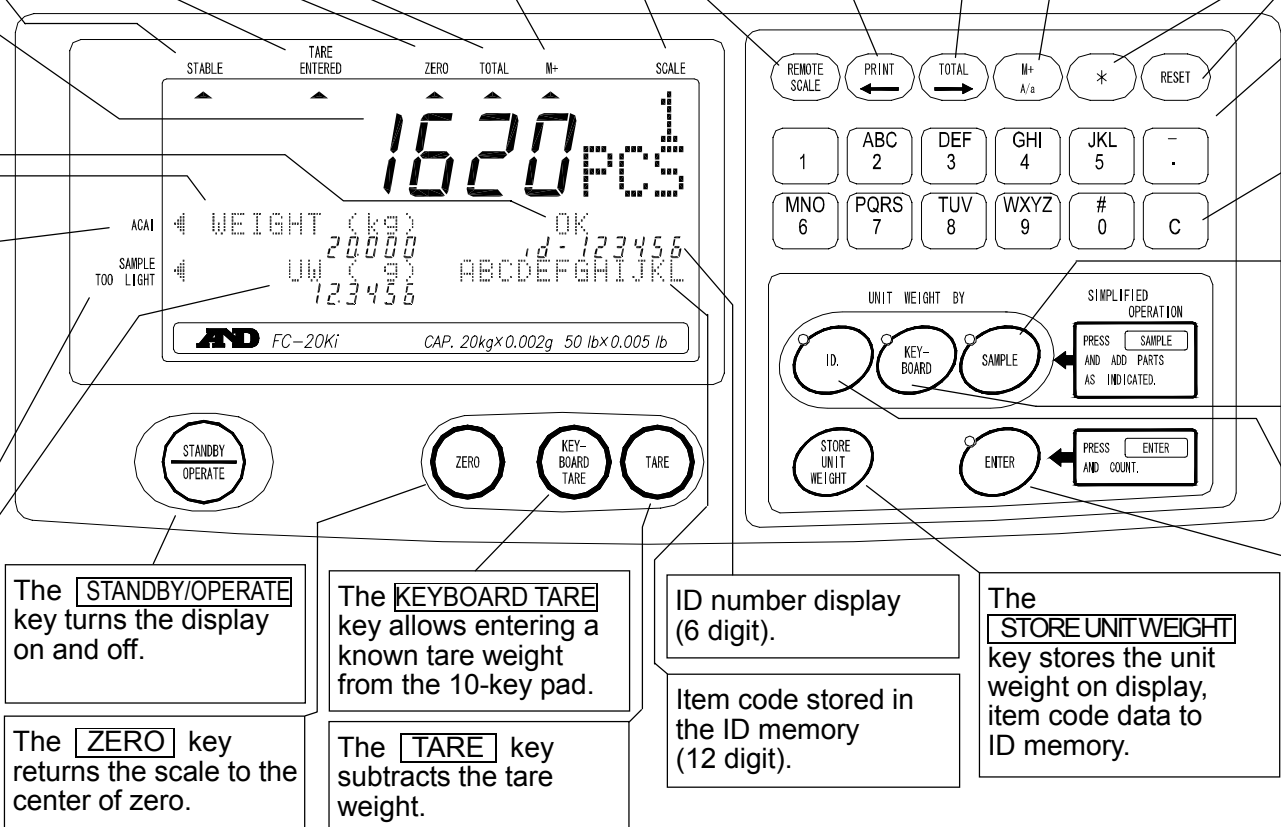

## 2. BASIC OPERATIONS

### 2-1. Basic Operations

#### Turn The Display ON and OFF

1. Press the **STANDBY/OPERATE** key to turn the scale on when displaying the standby indicator. The display will show all the display segments first and show "-----" while the weighing data becomes stable.
  - The range for power-on zero is  $\pm 10\%$  of the weighing capacity around the calibrated zero point.
  - If there is something more than 10% of the capacity on the weighing pan, the display will show "Err 1". Remove everything from the weighing pan or press the **RESET** key. When you press the **RESET** key, the power-on zero doesn't work.
2. The scale will automatically assume zero (power-on zero) and the display will show zero.
  - The range for power-on zero is  $\pm 10\%$  of the weighing capacity around the calibrated zero point.
3. Press the **STANDBY/OPERATE** key again, and the scale returns to the standby mode.

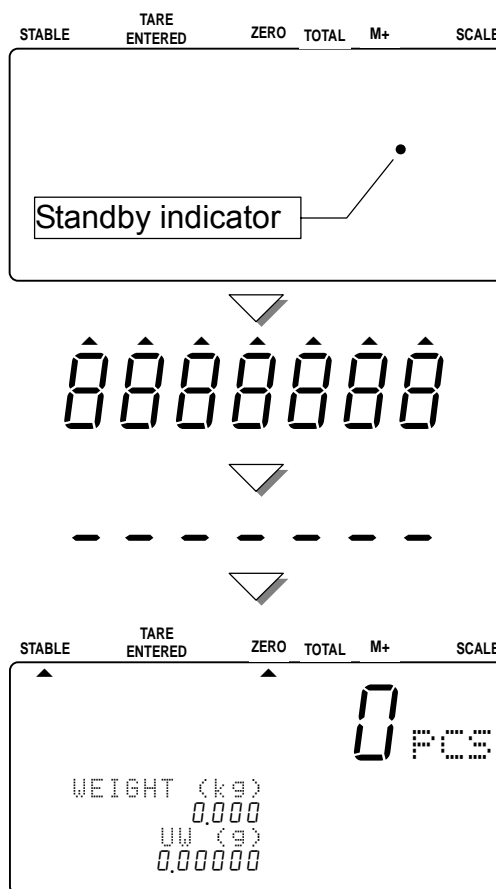
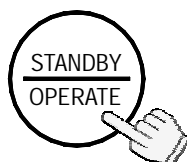

#### ZERO

- The **ZERO** key will bring the weight display back to zero as long as the weighing pan is empty or within 2% of capacity.
1. Remove everything from the weighing pan and press the **ZERO** key. Then the display shows "-----" and waits for the weighing data to become stable.
  2. The scale will zero and The ZERO indicator will come on to indicate that the scale is ready to start weighing or counting.
    - There is an automatic zeroing function called "zero tracking". The scale initially comes with this function enabled to take care of normal zero drift caused by changes in temperature, humidity, air pressure etc. (F-Function *F-04-01*).

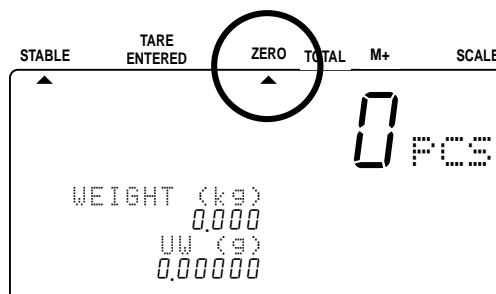

## TARE

- ❑ The **TARE** key will subtract the displayed container weight.

1. Remove everything from the weighing pan and press the **ZERO** key to zero the scale.

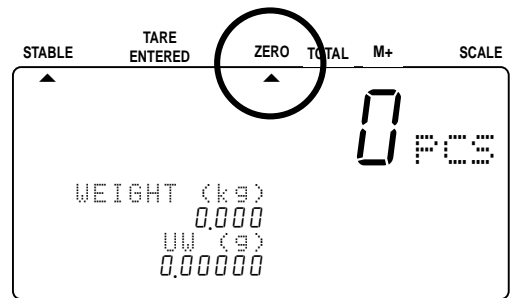

2. Place tare container on the weighing pan. The weight display will show the weight of the container.

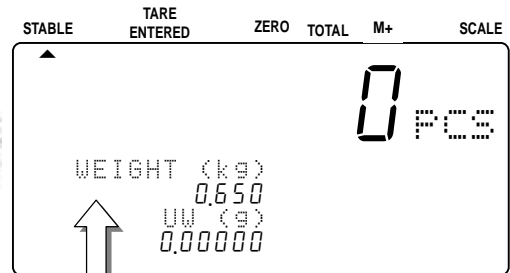
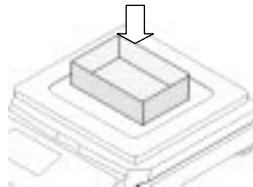

Container weight

3. Press **TARE** key. Then the display shows "-----" and waits for the weighing data to become stable.

4. The scale will subtract the weight of the container and the weight display changes to net weight.

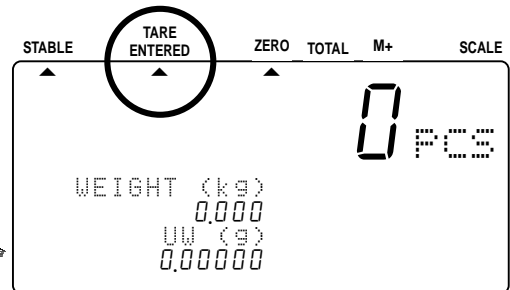
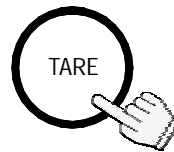

- ❑ The TARE ENTERED indicator will indicate.

## 2-2. To Start Counting

1. Press the **STANDBY/OPERATE** key to turn the scale on when displaying the standby indicator. Or press the **RESET** key to clear any previous operations.

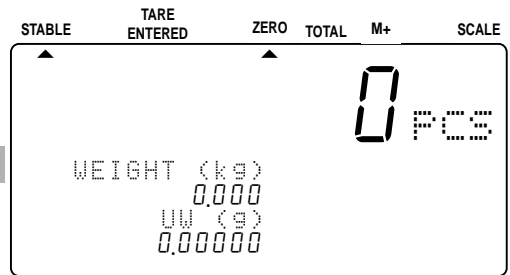

2. The three LED's on the **UNIT WEIGHT BY** keys will blink. This is to prompt you to select a method for entering a unit weight for operation.

3. select one of the ways to enter or recall the unit weight (the weight of one item of what you are counting), and refer to the section noted for more instructions.

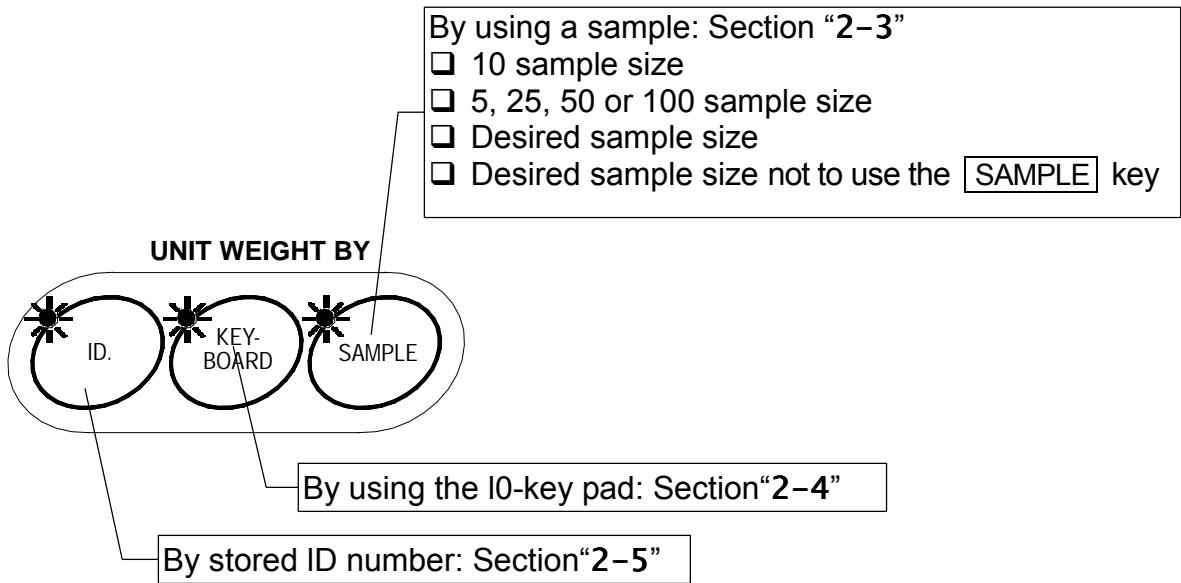



You can return to this point at any time during operation by pressing the **RESET** key. (This doesn't clear the entered tare weight and M+ memory.)



## 2-3. Unit Weight By Samples

### 10 Sample Size

- The three **UNIT WEIGHT BY** LED's should be blinking at this point, if not, press the **RESET** key to clear any unit weight. If you are going to use a tare container, place it on the weighing pan.

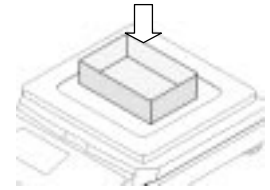

- Press the **SAMPLE** key. Any tare container will be automatically tared. The display Will show "Add Sample" and "10 pcs".

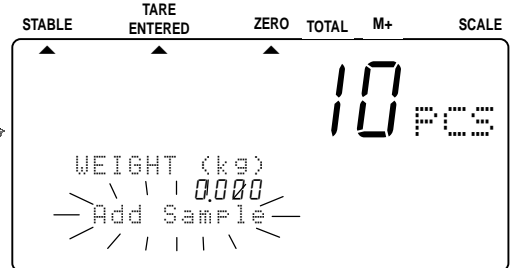
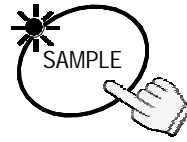

If weight isn't zero, press the TARE.

- Place 10 sample pieces on the weighing pan (or in the tared container). The weight of all 10 pieces will be displayed.

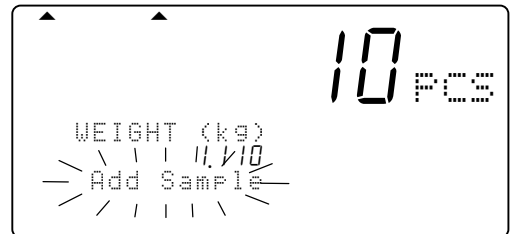
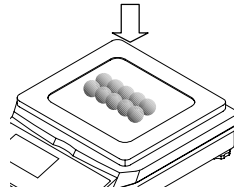

- Press the **ENTER** key. The display will show "-----" for a moment while calculating the unit weight. After a moment the display will show the count, total weight and unit weight.

≧Blinking≦

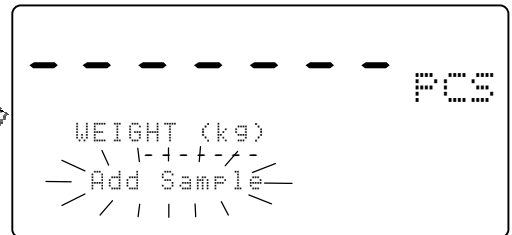
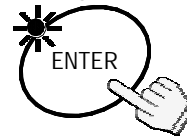

- At this point the scale may decide that 10 pieces is not a large enough sample size for accurate counting. If you refer to the "Add Sample" display again, then add the additional number of sample pieces displayed.

- You can ignore the "Add Sample" message and continue counting by pressing the **ENTER** key. However, the results may not be accurate. Refer to F-Function *F-01-02*.

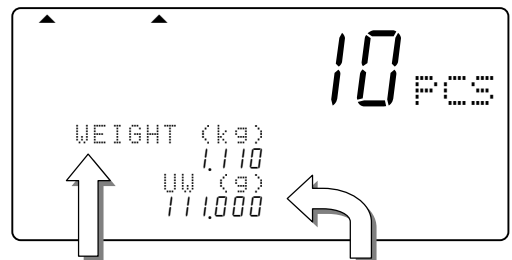

**Total Weight**  
The weight of all the sample pieces

**Unit Weight**  
The calculated weight of a unit.

- You may now begin counting operations for pieces of the same weight.

- Please refer to "10. ACAI FUNCTION" for information concerning the ACAI counting accuracy function.

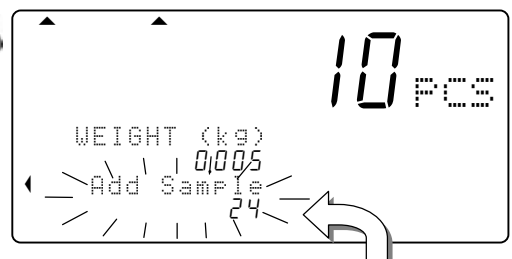

Another 24 pieces.

## 5, 25, 50 or 100 Sample Size

- The three **UNIT WEIGHT BY** LED's should be blinking at this point, if not, press the **RESET** key to clear any unit weight. If you are going to use a tare container, place it on the weighing pan.

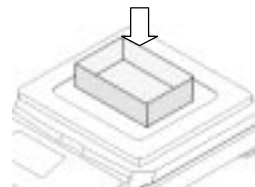

- Press the **SAMPLE** key. Any tare container will be automatically tared. The display will show "Add Sample" and "10 pcs".

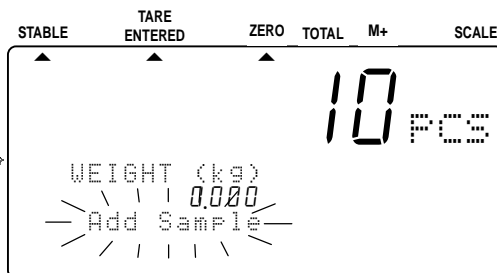
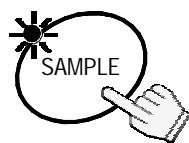

⚠ If weight isn't zero, press TARE.

- Press the **SAMPLE** key to move through the count number of 5, 25, 50 or 100 pieces.

- ❑ If the larger the sample size is used, the more accurate the unit weight registered. (Example of selecting a sample size of 50)

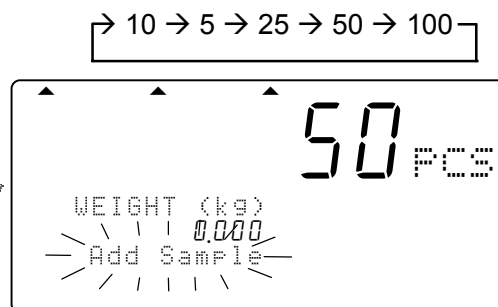
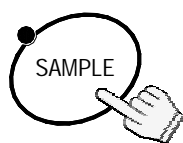

- Place the selected number of sample pieces on the weighing pan (or in the tared container). The weight of the pieces will be displayed.

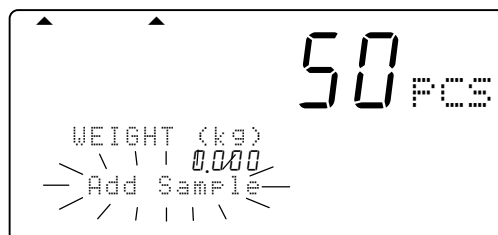
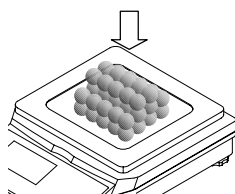

- Press the **ENTER** key. The display will show "-----" for a moment while calculating the unit weight. After a moment the display will show the count, total weight and unit weight.

⌘Blinking⌘

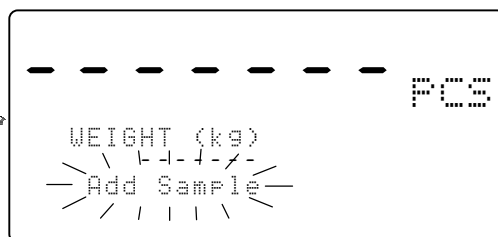
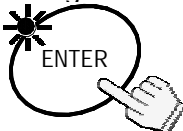

- ⚠ If the "Add Sample" display appears again, then the sample size is not large enough for accurate counting – add the additional number of sample pieces.

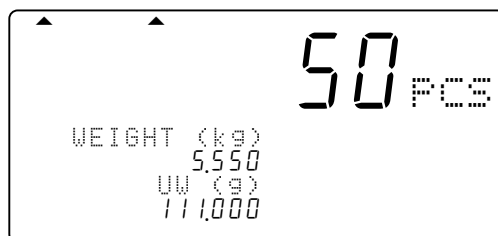

- You may now begin counting operations for pieces of the same weight.

## Desired Sample Size

1. The three **UNIT WEIGHT BY** LED's should be blinking at this point, if not, press the **RESET** key to clear any unit weight. If you are going to use a tare container, place it on the weighing pan.

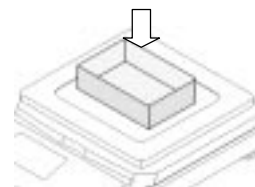

2. Press the **SAMPLE** key. Any tare container will be automatically tared or zeroed. The display Will show "Add Sample" and "10 pcs".

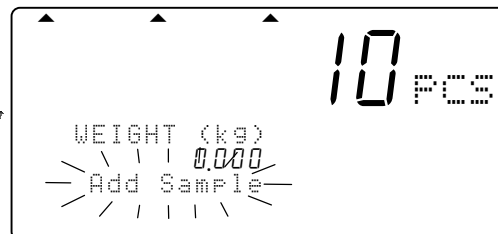
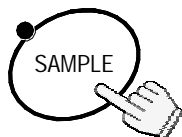

⚠ If weight isn't zero, press TARE.

3. Use the **0** → **9** 10-key pad to display the sample size desired.

- ❑ If you hit the wrong key, press the **C** key to clear and start again. (Example of selecting a sample size of 20)

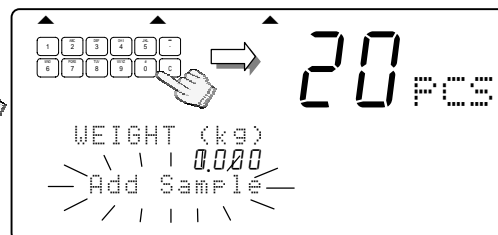
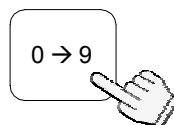

4. Place the selected number of sample pieces on the weighing pan (or in the tared container). The weight of the pieces will be displayed.

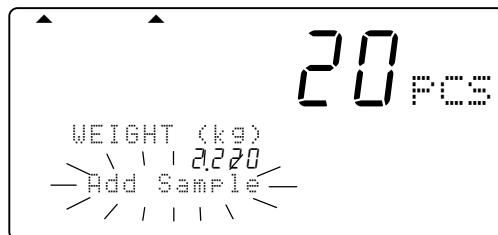
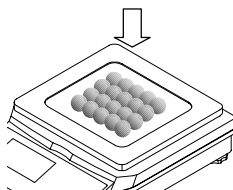

5. Press the **ENTER** key. The display will show "-----" for a moment while calculating the unit weight. After a moment the display will show the count, total weight and unit weight.

⚡Blinking⚡

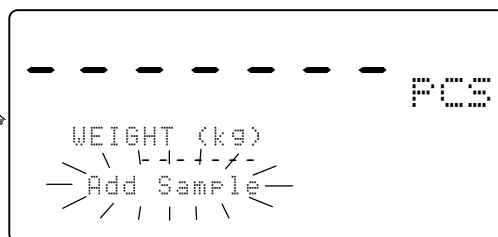
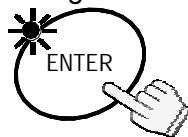

- ⚠ If the "Add Sample" display appears again, then the sample size is not large enough for accurate counting – add the additional number of sample pieces.

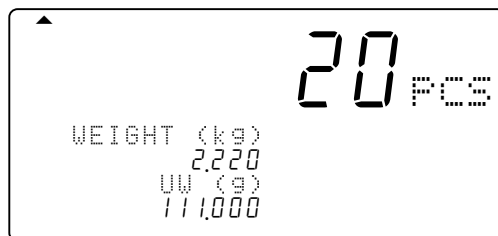

6. You may now begin counting operations for pieces of the same weight.

## Desired Sample Size Not To Use The **[SAMPLE]** Key

- The three **UNIT WEIGHT BY** LED's should be blinking at this point, if not, press the **[RESET]** key to clear any unit weight. If you are going to use a tare container, place it on the weighing pan and press the **[tare]** key. Be sure the weight display is "0".

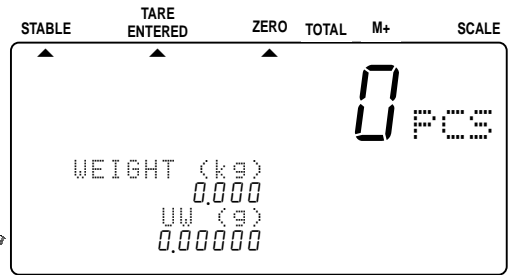
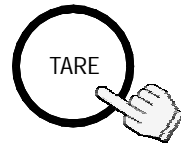
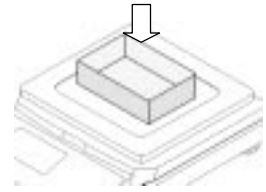

⚠ If weight isn't zero, press the TARE.

- Place sample pieces on the weighing pan (or in the tared container). The weight of the pieces will be displayed.

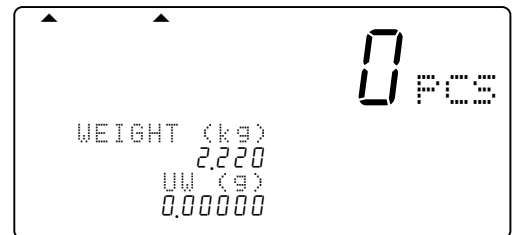
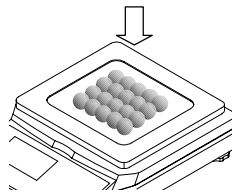

- Use the **[0] → [9]** 10-key pad to enter the sample size of the pieces you placed.
  - If you hit the wrong key, press the **[C]** key to clear and enter again. (Example of setting a sample size of 20)

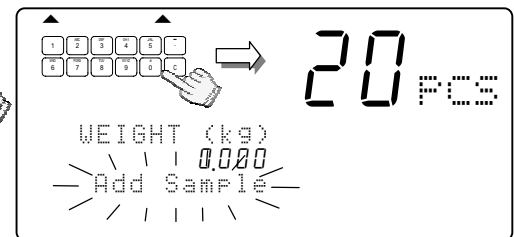
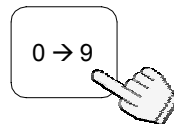

- Press the **[ENTER]** key. The display will show dashes for a moment while calculating the unit weight. After a moment the display will show the count, total weight and unit weight.

⤴Blinking⤵

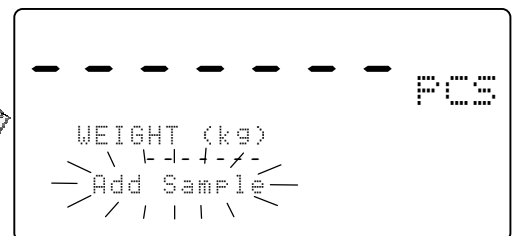
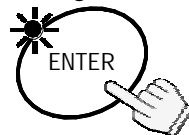

⚠ If the calculated unit weight is too light, "Lo wt" (low unit weight) will be displayed, and you will be returned to step 3.

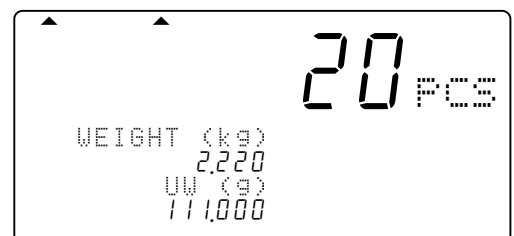

- You may now begin counting operations for pieces of the same weight.



## 2-4. Unit Weight By KEYBOARD

1. The three **UNIT WEIGHT BY** LED's should be blinking at this point, if not, press the **RESET** key to clear any unit weight. If you are going to use a tare container, place it on the weighing pan and press the **TARE** key to tare the container.

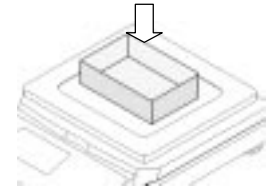

2. Press the **KEYBOARD** key. The unit weight display and the **ENTER** key LED will blink.

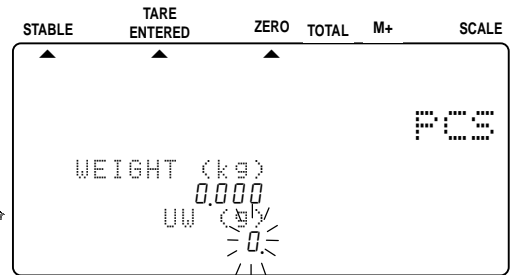
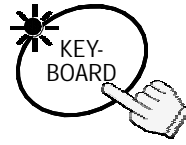

3. Use the **0** → **9** and **.** 10-key pad to display the unit weight.

- ❑ If you hit the wrong key, press the **C** key to clear and start again. (Example of a unit weight 32g)

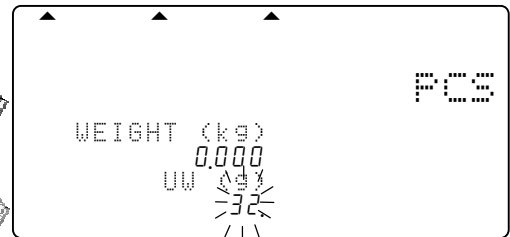
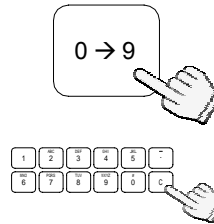

4. Press the **ENTER** key. The unit weight 32g will have been entered.

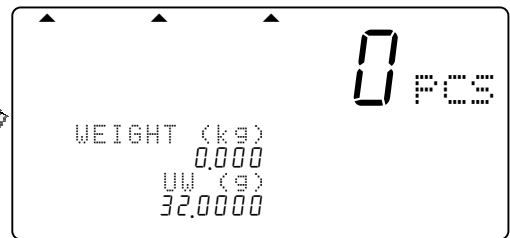
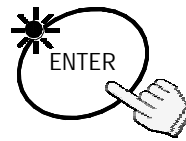

- ⚠ If the unit weight entered is too light, "Lo ut" (low unit weight) will be displayed, and you will be returned to step 3.

6. You may now begin counting operations for pieces of the same weight.

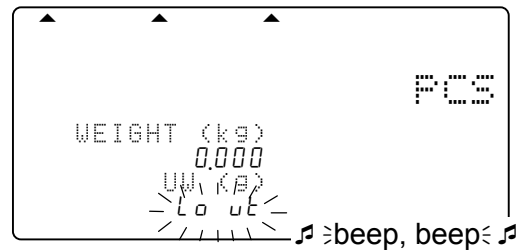

## 2-5. Unit Weight By ID Number

1. If there are no unit weight's stored in memory, refer to "4-1. Store Unit Weight by ID Numbers".

The three **UNIT WEIGHT BY** LED's should be blinking at this point, if not, press the **RESET** key to clear any unit weight.

2. Press the **ID** key.  
"id-000000" will be displayed with  $\Rightarrow 000000 \Leftarrow$  blinking.

- ❑ If you have been using the unit weight by ID number, its ID number stays displayed and blinks.

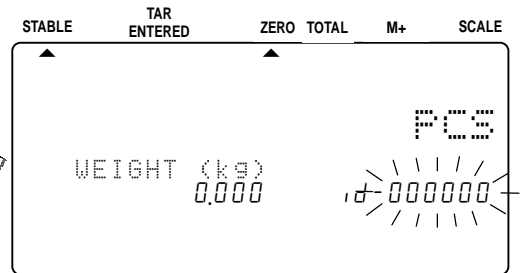
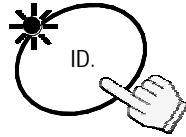

3. Use the **0** → **9** 10-key pad to display the ID number.

- ❑ If you hit the wrong key, press the **C** key to clear and start again. (Example of ID number "123456")

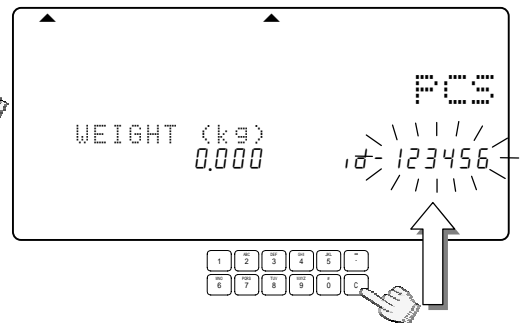
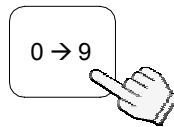

4. Press the **ENTER** key.  
The count display will show "0" and the scale will recall "12g" previously entered as the unit weight of ID 123456.

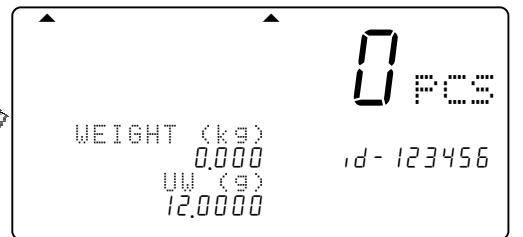
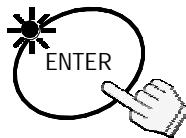

- ⚠ If there is no unit weight entered for the ID number you tried to recall, "no id" will be displayed, and you will be returned to step 3.

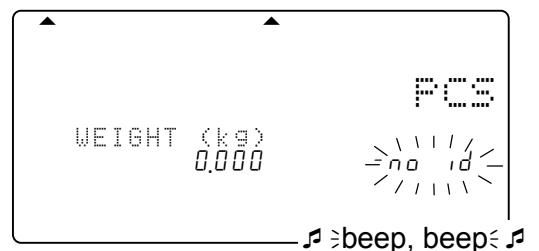

6. You may now begin counting operations for pieces of the same weight.



- ❑ "id-000000" is a special memory area. It always holds the last Unit Weight entered.
- ❑ When you register a Unit Weight, it is automatically placed in the ID "id-000000".
- ❑ If you clear the Unit Weight by pressing the **RESET** key, it can be recalled by recalling the ID "id-000000".

# 3. ENTERING A TARE WEIGHT

There are two methods of tare operations.

- ❑ Using the **TARE** key to subtract the displayed container weight directly. Please refer to “2-1. Basic Operations”.
- ❑ Using the **KEYBOARD TARE** key to enter a tare weight via the 10-key pad.

## 3-1. Using the KEYBOARD TARE Key

1. Remove everything from the weighing pan and press the **ZERO** key to zero the scale.

2. Press the **KEYBOARD TARE** key.  
The weight display will blink (display is any tare weight previously entered).

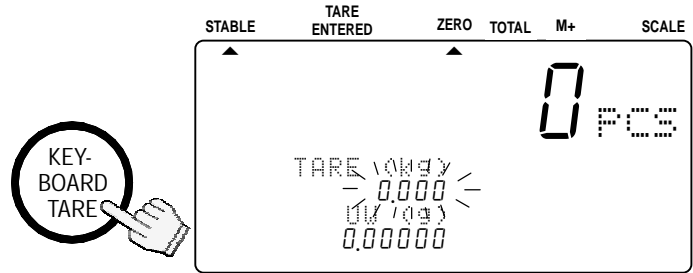

3. Use the **0** → **9** and **.** 10-key pad to display the desired TARE weight.

❑ If you hit the wrong key, press the **C** key to clear and start again.  
(Example of a tare weight 615g)

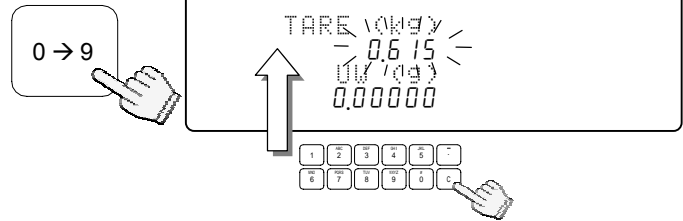

4. Press the **ENTER** key.  
The weight display changes to net weight.

❑ The TARE ENTERED indicator will light.

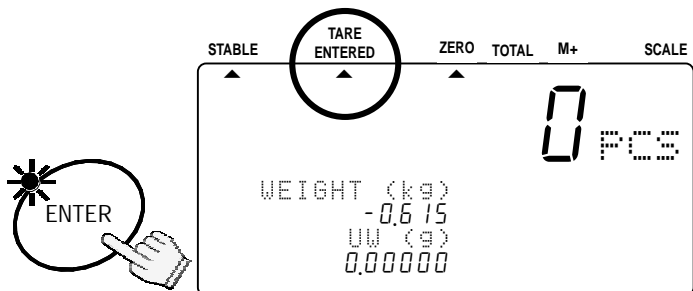

### 3-2. To Clear TARE

Either:

1. Have nothing on the weighing pan.
  - If the ZERO indicator is not displayed, press the **ZERO** key to zero the scale.

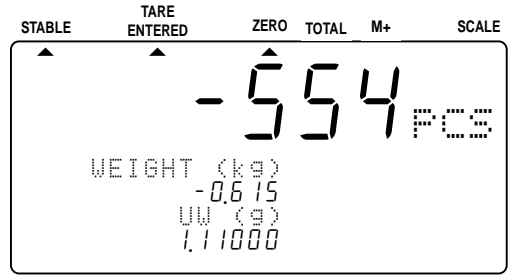

2. Press the **TARE** key.  
The weight display will go to "0", and the TARE ENTERED indicator will be turned off (tare cleared).

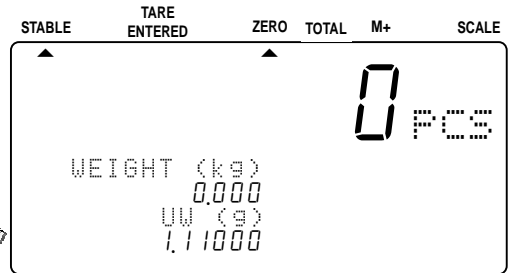

Or:

1. Press the **KEYBOARD TARE** key.  
The weight display will blink (display is any tare weight previously entered).

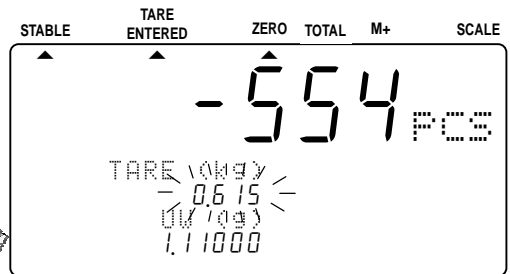

2. Press the **0** key and press the **ENTER** key.

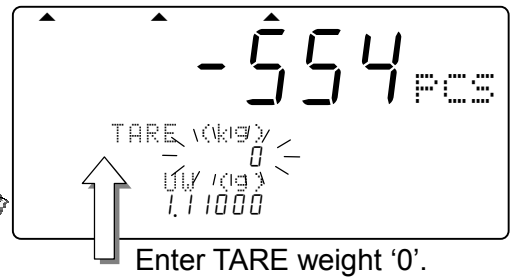
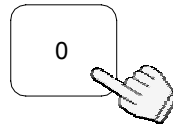

3. The tare weight is cleared and the TARE ENTERED indicator will be turned off.

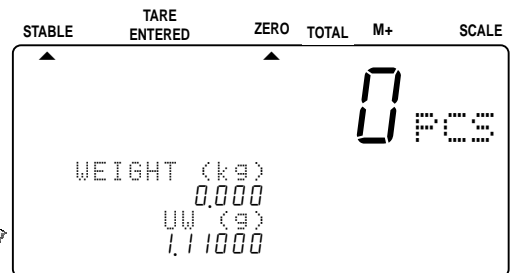
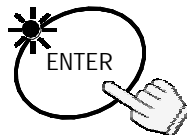

# 4. STORE UNIT WEIGHT

## 4-1. Store Unit Weight by ID Numbers

The scale can store up to 500 unit weights by 6 digit ID numbers, from 000001 to 999999. To recall, refer to “2-5. Unit Weight By ID Number”.

- The scale is initially set to store the ID numbers with a unit weight and an item code only. However, it can be set to store a tare weight, comparator limits and total count by setting F-Function *F-01-05*.

1. First register a unit weight by any method – using a sample or via the 10-key pad – and have it displayed.

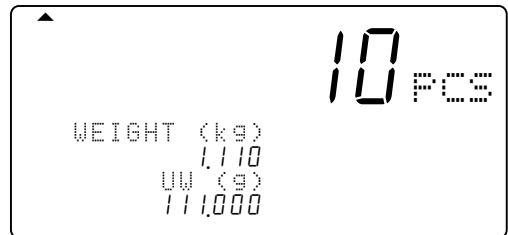

2. Press the **STORE UNIT WEIGHT** key. “id-000000” will appear with  $\geq 000000 \leq$  blinking.

- If you have been using the unit weight by ID number, its ID number stays displayed and blinks.

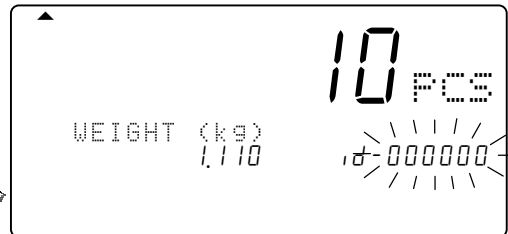

3. Use the **0** → **9** 10-key pad to display the new ID number.

(Example of ID number “123456”)

- If you hit the wrong key, press the **C** key to clear and start again.

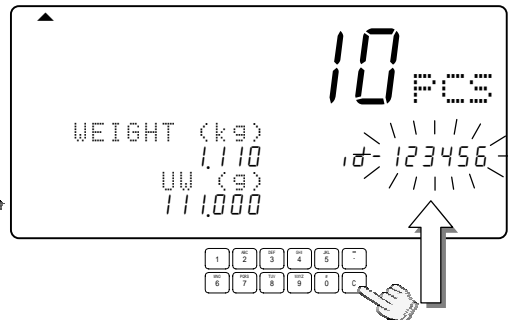
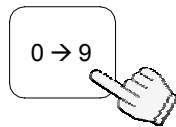

4. Press the **ENTER** key.

The ID number is stored and the display returns to normal.

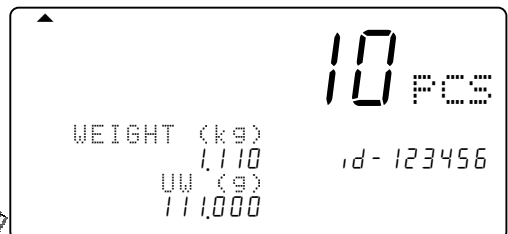
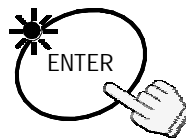

- ⚠ If the same ID number was previously stored, the scale beeps twice and the ID number display blinks.  $\geq id-123456 \leq$   
You must then select one of two options:  
either (a) Overwrite the old ID unit weight,  
or (b) Select a different ID number:

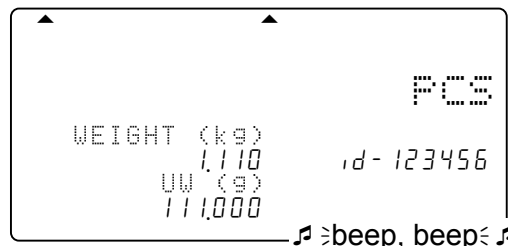

**(a)** Press the **ENTER** key to overwrite the old ID number.

OR

**(b)** Press the **C** key to clear and go to step 3.

## 4-2. Clearing A Stored Unit Weight

1. Press and hold the **C** key, then press the **STORE UNIT WEIGHT** key – release both.

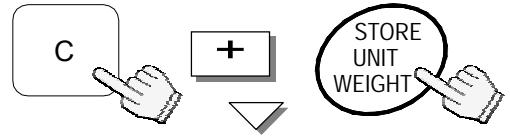

2. "Clear ID" will appear and "id-000000" will appear with  $\Rightarrow 000000 \Leftarrow$  blinking.

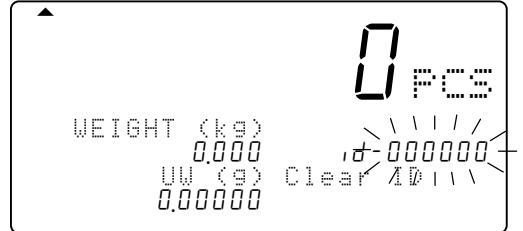

3. Use the **0** → **9** 10-key pad to display the ID number to clear.  
(Example of ID number "123456")

- ❑ If you hit the wrong key, press the **C** key to clear and start again.

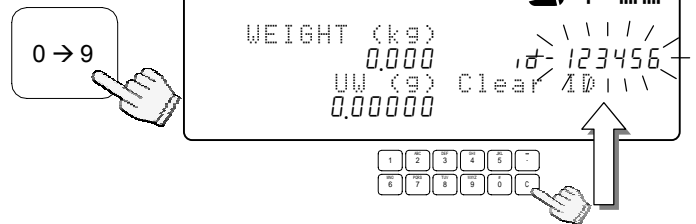

4. Press the **ENTER** key.  
After showing "id-----" for a moment, the ID number will be cleared and the display returns to normal.

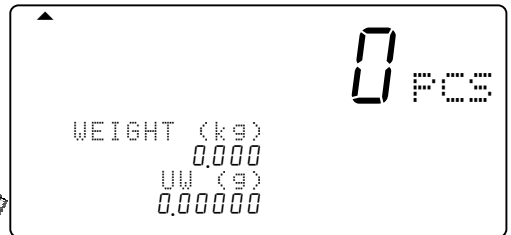
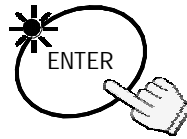

- ⚠ If there is no such ID number to clear, the scale will beep. Return to step 3 to try again, or press the **RESET** key to exit.

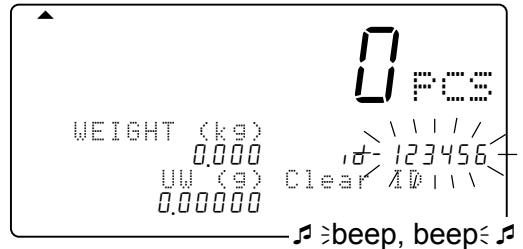

### Clearing All ID Memories at Once

1. In the step 2 above, press the **TOTAL** key.  
"id-ALL" will appear with  $\Rightarrow ALL \Leftarrow$  blinking.

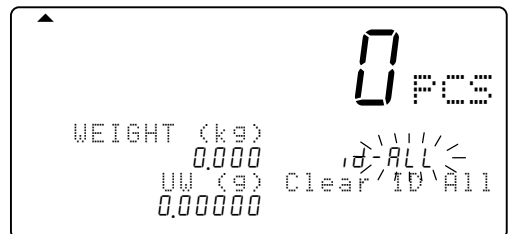
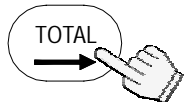

2. Press the **ENTER** key, then  $\Rightarrow ALL \Leftarrow$  blinking will stop.



3. Press the **ENTER** key again to clear all of ID memories. Press the **RESET** to exit without clearing ID memories.  
The display will return to normal.

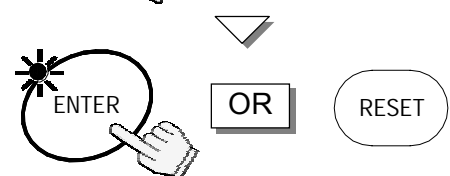

## 4-3. Store Item Code by ID Number

Item code of up to 12 alphanumeric characters can be set using the 10-key pad, and it will be stored with the ID numbers.

1. Press the **STORE UNIT WEIGHT** key. "id-000000" will appear with  $\text{000000}$  blinking.

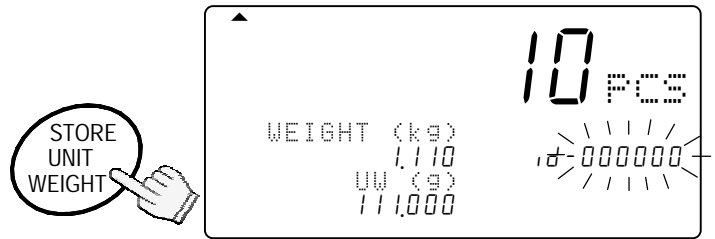

2. Enter the ID number desired using the **0** → **9** 10-key pad.

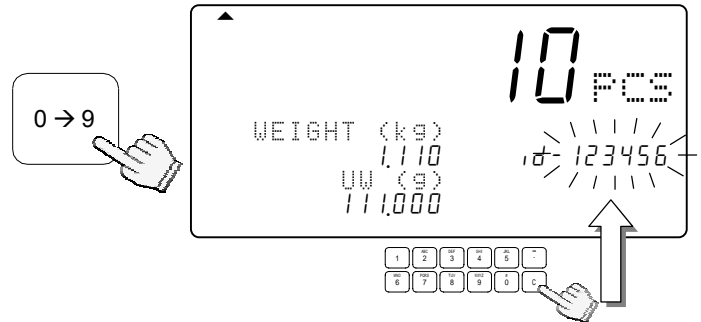

3. Press the **STORE UNIT WEIGHT** key again. The symbol "A" with blinking cursor  $\text{A}$  will appear.

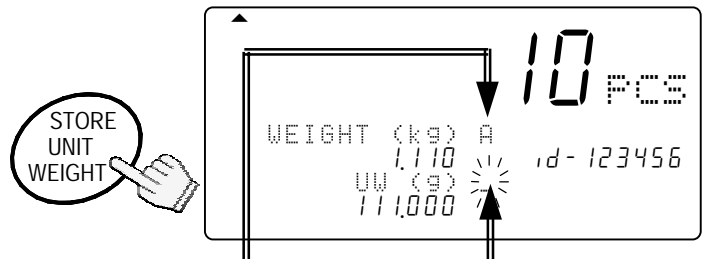

- To return to step 2, press the **STORE UNIT WEIGHT** key.

- ⚠ To select the symbol "A", "a" or "1", press the **M+** (A/a) key.

This shows which type of character will be entered.

A: Capital letter  
a: Lowercase letter  
1: Numeric character

Cursor can be moved using **→** and **←** keys.

Example of entering "A&D Co., Ltd.": Select the symbol "A" first.

4. Press the **2** (ABC) key to place "A".
  5. Press the **0** (#) key several times to place "&".
  6. Press the **3** (DEF) key to place "D".
  7. Press the **TOTAL** (→) key twice to shift the cursor.
  8. Press the **2** (ABC) key several times to place "C".
  9. Press the **M+** (A/a) key to change the symbol "A" to "a".
  10. Press the **6** (MNO) key several times to place "o".
- Repeat these procedures to the last letter.

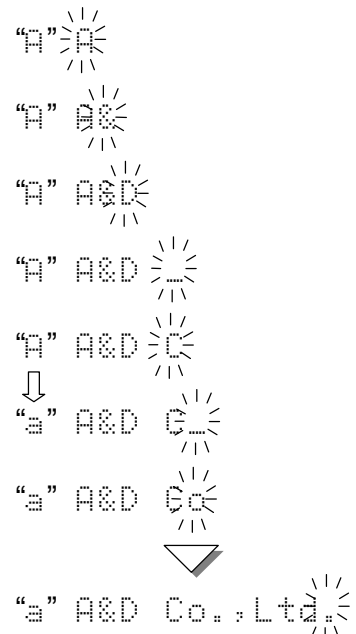

11. Press the **ENTER** key.  
The ID number is stored with Item code and the display returns to normal.

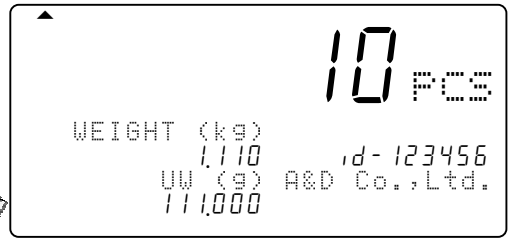
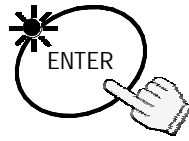

- You may return to step 2 by pressing the **STORE UNIT WEIGHT** key.

If the same ID number was previously stored, the scale beeps twice.

You must then select one of two options: either (a) Overwrite the old ID unit weight, or (b) Select a different ID number:

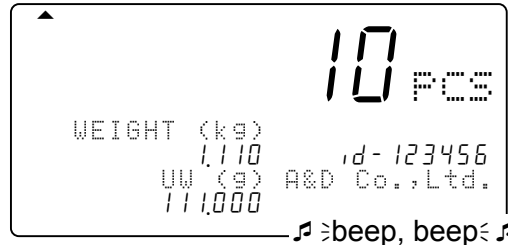

(a) Press the **ENTER** key to overwrite the old ID number.

OR

(b) Press the **C** key to clear and retype the new ID number.

## Alphanumeric Character Table

Key	Capital Letters	Lowercase Letters	Numeric Characters
1		@ [ ] ^ _	1
2	A B C	a b c	2
3	D E F	d e f	3
4	G H I	g h i	4
5	J K L	j k l	5
6	M N O	m n o	6
7	P Q R S	p q r s	7
8	T U V	t u v	8
9	U X Y Z	u x y z	9
0	# \$ % & ' ( ) * + ,		0
.	- . / ! " # ; < = > ?		.
C	Clear (Space)		

- STORE UNIT WEIGHT** : ID number input  $\leftrightarrow$  Item code input
- PRINT  $\leftarrow$**  : To shift the cursor left
- TOTAL  $\rightarrow$**  : To shift the cursor right
- M+ A/a** : Capital  $\rightarrow$  Lowercase  $\rightarrow$  Numeric  $\rightarrow$  Capital  $\rightarrow$  ...



## 4-4. Unit Weight, Tare, Comparator Limits & Total Count Stored

The scale is initially set to store the ID numbers with a unit weight and an item code only. However, it can be set to store a tare weight, comparator limits and/or total count also by setting F-Function  $F-01-05$ .

1. First register a unit weight and a tare weight by any method. If necessary, set the comparator limits and use the M+ accumulation.
2. Go to step 2 of section “4-2. Store Unit Weight By ID Numbers”.

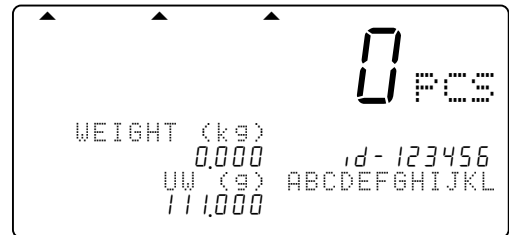

 When you recall a unit weight by the ID key, the tare, comparator limits and/or total count are also recalled along with the unit weight.



“ $id-00000$ ”, the special memory area, does not store a tare weight, comparator limits and total count along with unit weight.

# 5. USING THE M+ MEMORY

## 5-1. The M+ Memory Function

- ❑ The scale can accumulate count data by pressing the **M+** key, or automatically (refer to the next page). It also keeps track of the number of times you add to the total.
- ❑ When you view the total by pressing the **TOTAL** key, you view the number of pieces accumulated and the number of additions (how many times the total was added to). Please refer to “5-2.” and “5-3.” to view or clear the total count.

### Adding Using the M+ Key

- ❑ When stable count data is displayed:

1. Press the **M+** key.  
The **M+** indicator will blink for a few seconds.

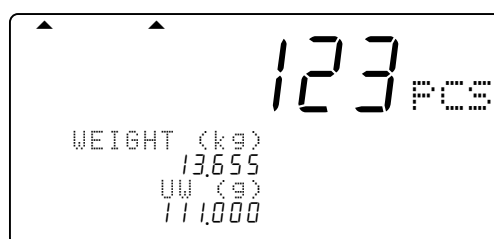

- ⚠ If the scale beeps 4 times, or the **M+** indicator did not blink, then refer to the note below.

- ⚠ The **M+** indicator will stay ON while there is count in memory.

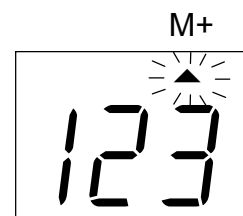
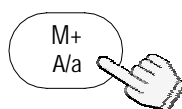

2. Press the **M+** key every time you want to add to the count. Remember that you may only add the count data once – the scale must return to near zero before it will let you add again.



- ❑ The **M+** key is accepted only once for every stable count data. Once accepted, the **M+** key is prohibited until the display returns to less than +5d (1d = 1 weighing division).
- ❑ If *F-03-02* is set at “1”, then the **M+** key can accumulate negative data. Once the **M+** key is accepted, weight data must return within  $\pm 5d$  before the next accumulation.
- ❑ To store the total count in the ID number, refer to “4-4. Unit Weight, Tare, Comparator Limits & Total Count Stored”.
- ❑ The total count is not stored in the ID memories automatically even if it was recalled by ID number.

### To Erase the Last M+ Addition

1. Press and hold the **C** key, then press the **M+** key – release.
2. The scale will clear the last **M+** addition.

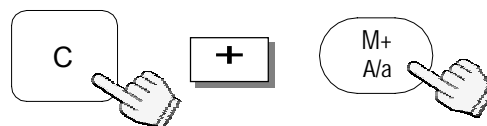

- ⚠ If the scale beeps 4 times, there is no **M+** addition to erase.

## Automatic M+ Accumulation Mode

- ❑ M+ Accumulation can also be done automatically each time you count a different batch, As soon as you have a stable count, it will be added to the M+ memory and the scale will beep. The weight display will have to return to near zero before another count can be added.

⚠ Automatic M+ accumulation is set by F-Function F-03-01 at "1".

⚠ Only positive counts can be added. If F-Function F-03-02 is set at "1" (to accept negative count data), it will be ignored.

⚠ Once there is an automatic M+ accumulation, the display must return to less than +5d before another count can be accumulated.

### 5-2. Viewing the M+ Total

1. Press the **TOTAL** key.  
The count display will show the total count and the ▲TOTAL indicator will come ON.  
The number of additions to the M+ memory is also shown.
2. Press the **TOTAL** key again.  
The display will return to normal.

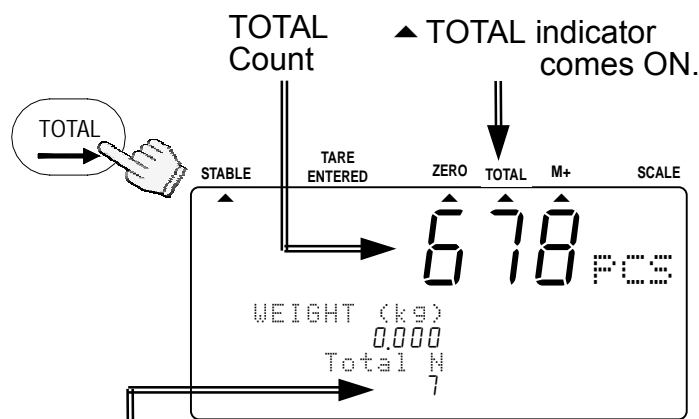

Number of additions to M+ memory

### 5-3. Clearing the M+ Total

1. Press and hold the **C** key, then press the **TOTAL** key – release both.
2. The scale will clear the M+ memory, and the ▲TOTAL indicator and the ▲M+ indicator will go OFF.

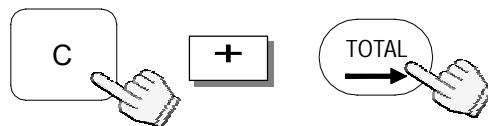

- ❑ The **RESET** key does not clear the total data.
- ❑ The total data is held in memory, but if AC/Battery power to scale is interrupted, the total data will be lost.

### 5-4. The M- Function

- ❑ The scale can subtract count data from M+ memory by using the **\*** key.
- ❑ Set the F-Function F-09-01="1" to use the **\*** key as **M-** key.

⚠ This function is not to clear the last M+ addition, but to subtract count data instead of addition. The number of additions is increased.

⚠ There is no automatic M- function.

# 6. COMPARATOR FUNCTION

- ❑ The scale contains a comparator function that checks the amount on the weighing pan against set acceptable count or weight levels. When the comparator function is activated, "HI", "OK" or "LO" is displayed.
- ❑ Before the comparator will work, upper and lower limits must be set (refer to below). The levels are set by count or weight. So, if you are using weight for your comparator levels, calculate the weight before starting the procedure below.
- ❑ If the OP-04 is installed, comparator relay output is also available.
- ❑ The comparator responds as follows,
  - "HI" Upper limits < Count / Weight data
  - "GO" Lower limits ≤ Count / Weight data ≤ Upper limits
  - "LO" Count / Weight data < Lower limits

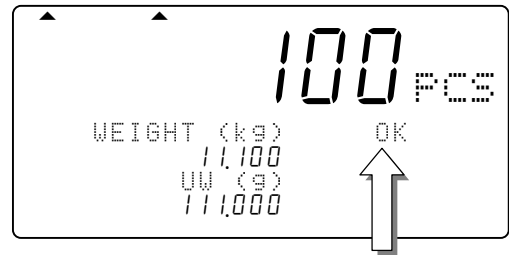

♪ ≧beep, beep ...≦ ♪

Upper limit 102 pcs  
 Lower limit 98 pcs  
 The beeper is set ON at "OK".

## To Set the Comparator

- ❑ Start with the scale in standby mode, display OFF.

1. Press and hold the **ZERO** key, then press the **STANDBY/OPERATE** key – release both.

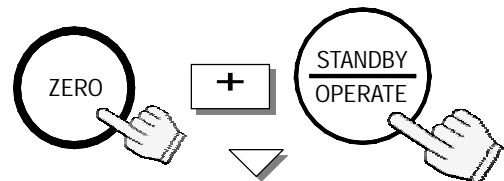

The count display will show "F-00" with "00" blinking.

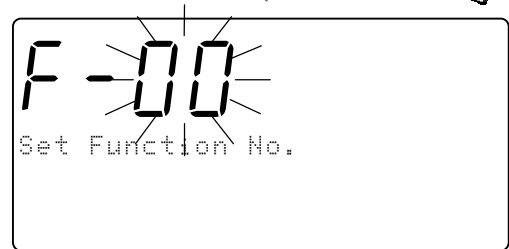

2. Press the **5** key to enter into the F-Function **F-05-X Comparator**.

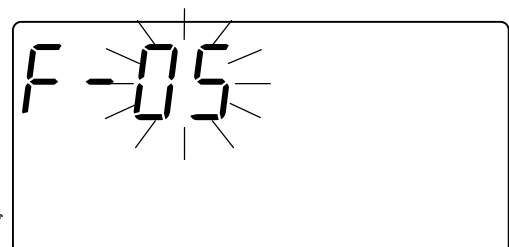
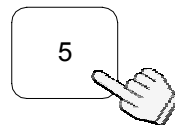

3. Press the **ENTER** key.  
 The count display will show the F-Function and its present setting will blink.

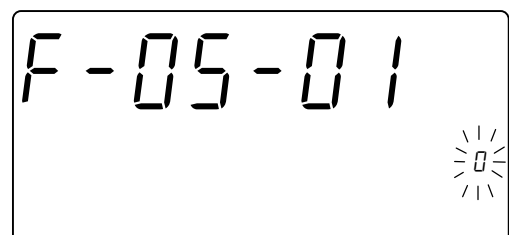

- Use the **[0]** → **[5]** keys to display the number of the desired setting.

For example, let's select "1" compare all data.

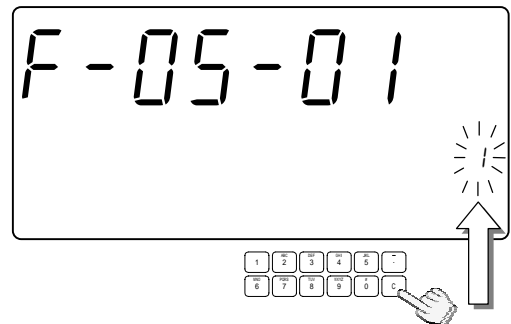

- Press the **[ENTER]** key to save the setting and move to next F-Function, *F-05-02*.

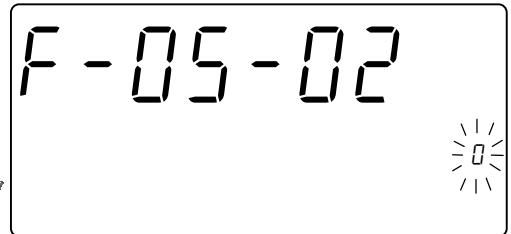

- Continue to enter *F-05* comparator settings – refer to "9-2. F-Functions" for a listing. If there are no changes to a F-Function, press the **[ENTER]** key to move to the next.

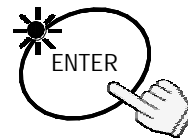
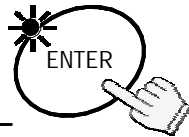

**To ENTER  
or  
MOVE to next**

- When finished: press the **[STANDBY/OPERATE]** key to exit. Then, press it to turn the display back ON. Comparator functions will now operate as set.

## Viewing Comparator Limits

- The comparator limits you are using will be shown by pressing the **[\*]** key.
- Set *F-09-01="0"* to use with this mode.

- Press the **[\*]** key, then upper and lower limits will be shown.
- Press the **[\*]** key twice, the display will return to normal.

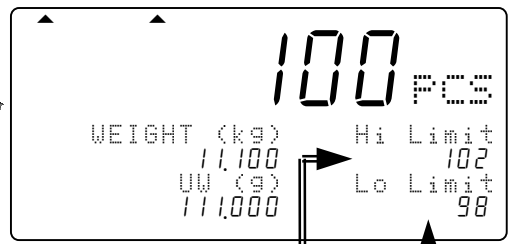
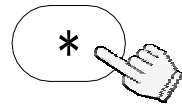

*Upper limit*      *Lower limit*

## Changing Comparator Limits Temporarily

- Set *F-09-01="0"* to use with this mode.

- In the step 1 above, press the **[ENTER]** key, then Upper limit value will blink.

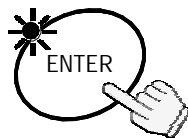

- Change the upper limit using 10-key pad and press the **[ENTER]** key. The upper limit will stop blinking and the lower limit blinks.

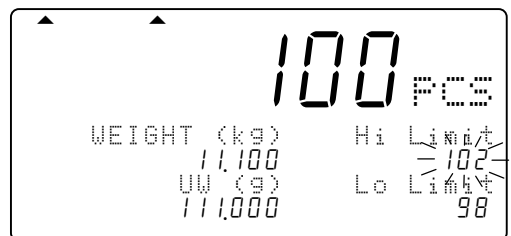

- Change the lower limit using 10-key pad and press the **[ENTER]** key. Then the display will return to the step 1 above with new limits.

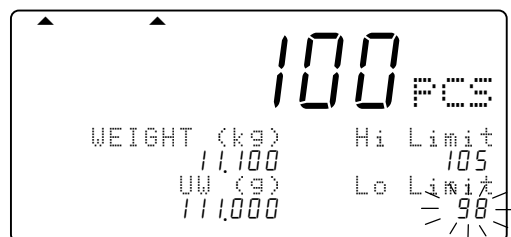

These temporary limits disappear when the display is turned off.

# 7. TIME AND DATE FUNCTION

- ❑ The FC-i scale has a time and date function and that data can be sent through the RS-232C interface. There are two ways to set time and date.

## To Set in the F-Function Settings

- ❑ Start with the scale in standby mode that the display is turned off.

1. Press and hold the **ZERO** key, then press the **STANDBY/OPERATE** key – release both to enter the F-Function setting mode. The count display will show “F-00” with “00” blinking.

2. Key in **1 1** and press the **ENTER** key to display the setting value, time and date. If you want to change the order of year, month and date, use the **0** → **2** to change the setting.

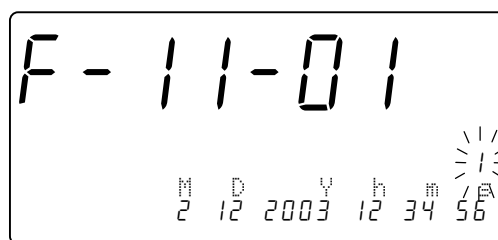

3. Press the **C**. The first digit of time and date will blink. Use the 10-key pad to set the time and date.

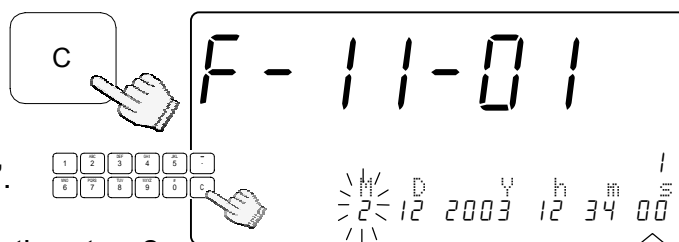

- ⚠ The value of “second” is fixed to “00”.

4. Press the **ENTER** key to return to the step 2 and the clock will start from “00” second.
5. Press the **STANDBY/OPERATE** key to exit, and press it to turn the display back ON.

The second display is fixed to “00”.

## Using the **\*** Key to Set the Time and Date

- ❑ Set the F-Function F-09-01=0 to use the **\*** key as this function.

1. Press the **\*** key twice to display the time and date.

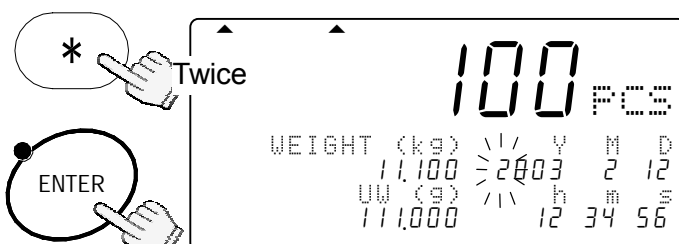

2. Press the **ENTER** key, then the first digit of date will blink.

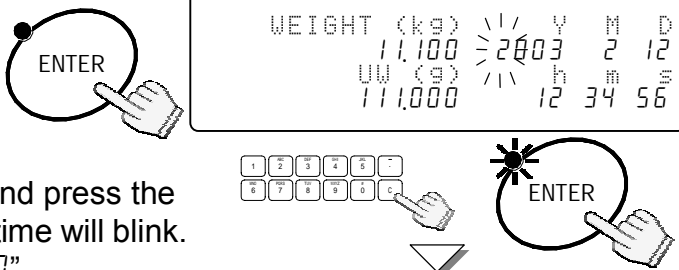

3. Use the 10-key pad to set the date and press the **ENTER** key. Then the first digit of time will blink.

- ⚠ The value of “second” is fixed to “00”.

4. Use the 10-key pad to set the time and press the **ENTER** key to return to the step 1 and the clock will start from “00” second.

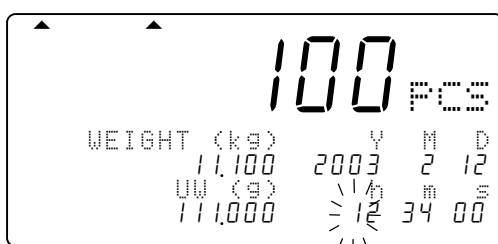

5. Press the **\*** key. The display will return to normal.

# 8. CALIBRATION

❑ Calibration of the FC-*i* scales is required when it is initially installed, if it is moved often, or it is moved a substantial distance. Calibration is also necessary in regular scale maintenance due to normal mechanical wear-and-tear, changes in seasonal temperature, humidity, air pressure, etc.

⚠ The scale is equipped with gravity compensation, which allows it to be calibrated in one location and then adjusted to match the gravity acceleration at another location where it will be used. But don't worry about this, as far as you calibrate the scale using a calibration weight and use it at same place.

⚠ The scale must be perform "warm up" (that leave the situation connected the AC adapter) for at least 30 minutes before starting calibration.

## 8-1. Calibration Procedure Using a Weight

⚠ The scale should have power connected at least one-half hour to warm it up before starting the calibration procedure.

1. Remove the calibration switch cover, and press the calibration (CAL) switch. The scale shows "CAL" in the count display.

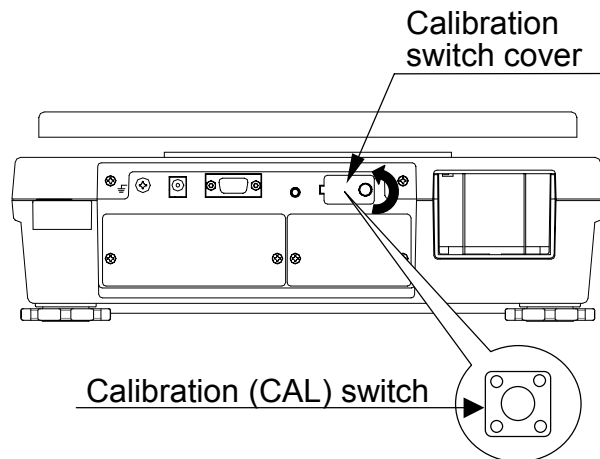
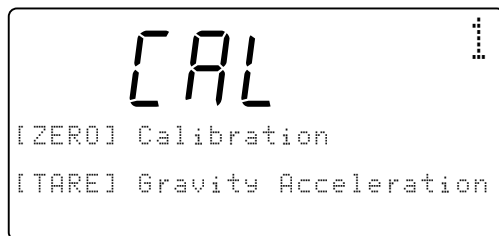

❑ Press the CAL switch to exit without calibrating the scale.

2. Press the **[ZERO]** key to enter into zero & span calibration mode.

❑ The display flashes the required calibration weight value.

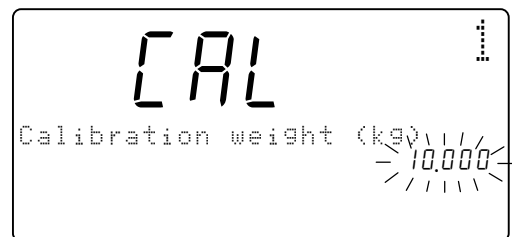

⚠ If you know the exact weight value, or if you wish to use a different weight, use the **[0]** → **[9]** and **[.]** 10-key pad to display the desired calibration weight. (For example: Using 10kg calibration weight that actually weighs 10.02kg.)



3. Press the **ENTER** key.  
The calibration weight stops blinking and "CAL 0" appears.

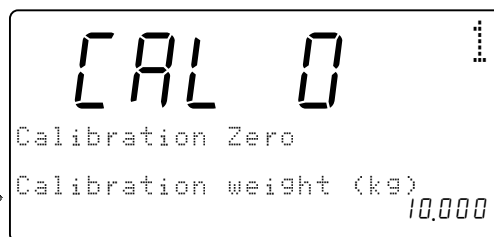
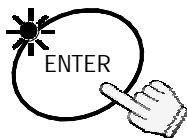

4. Making sure that there is nothing on, or touching the weighing pan, press the **ENTER** key.  
When zero calibration is completed, the display will show "CAL F".

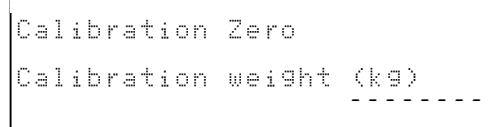

- ⚠ If you don't need span calibration, press the CAL switch to exit from the calibration procedure.

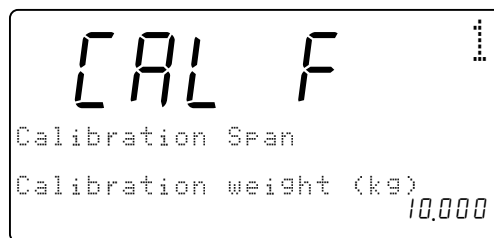

5. Place the calibration weight on the weighing pan and press the **ENTER** key.  
When span calibration is completed, the display will show "Calibration End".

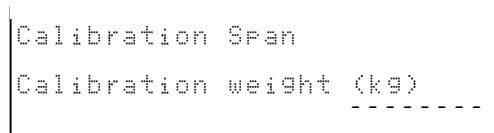

- ⚠ If the calibration weight is not what it should be, an error will be displayed. Check if the weight is correct and try again.

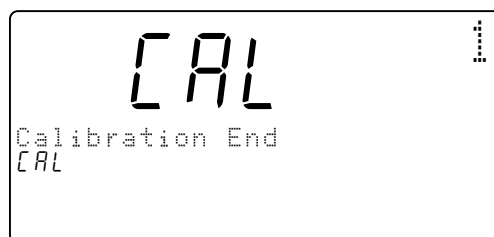
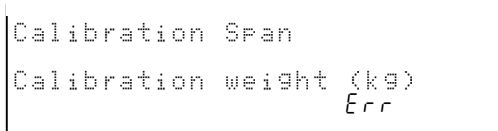

6. Press the **CAL** switch and re-attach the calibration switch cover.  
(End of the calibration procedure.)



If the scale will be moved to another place, set the gravity acceleration value before calibration. The value must be of the area where the calibration is to be done.



## 8-2. Gravity Compensation

⚠ When the scale is first used or has been moved to different place, it should be calibrated using a calibration weight.

But if the calibration weight cannot be prepared, the gravity acceleration correction will compensate the scale. Change the gravity acceleration value of the scale to the value of the area where it will be used. Refer to the gravity acceleration map appended to the end of this manual.

1. In step 1 of the previous procedure, press the **TARE** key.

The display flashes the gravity acceleration value stored in the scale.

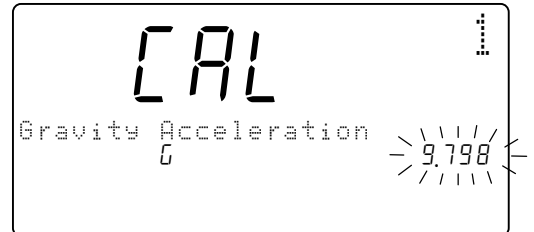

2. Use the **0** → **9** and **.** 10-key pad to display the desired gravity acceleration value. (Example of the value 9.800 m/s<sup>2</sup>.)

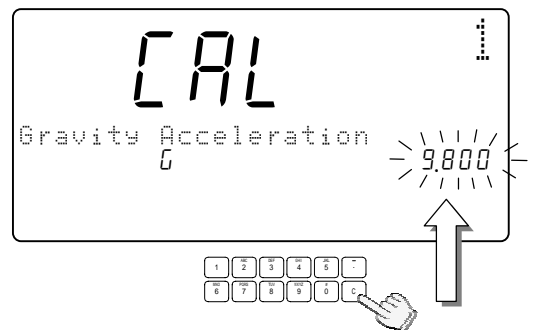

3. Press the **ENTER** key. The scale will store the new value. If necessary to calibrate the scale using a weight, go to step 2 of the previous section.

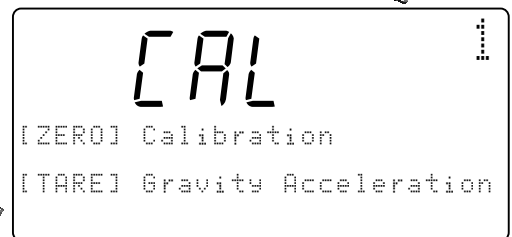
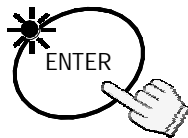

4. Press the **CAL** switch and re-attach the calibration switch cover. (End of the calibration procedure.)

# 9. F-FUNCTION PARAMETERS

## 9-1. To Change or View F-Function Settings

❑ Start with the scale in standby mode that the display is turned off.

1. Press and hold the **ZERO** key, then press the **STANDBY/OPERATE** key.

The count display will show "F-00" with "0" blinking. Then release the both keys.

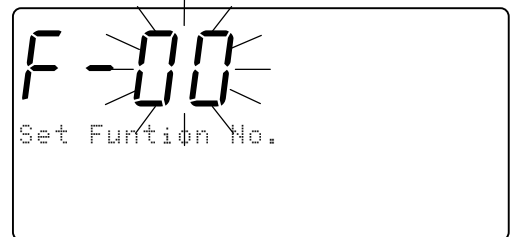
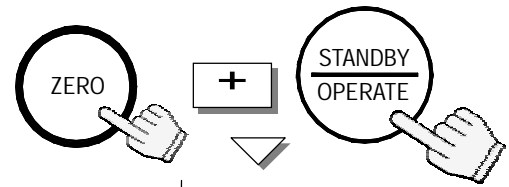

2. Press the **0** → **9** keys to display the number of the F-Function.

❑ For example: the **5** key to enter into the F-Function **F-05-X Comparator**.

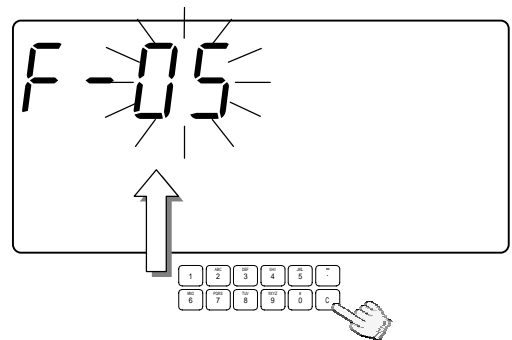

3. Press the **ENTER** key.  
The count display will show the F-Function and its present setting will blink.

4. You may now either change the setting (step 5) or move to the next F-Function (step 6).

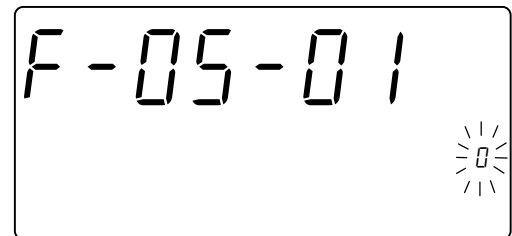

5. Use the **0** → **9** keys to change the setting.

⚠ The **C** key clears the input setting if you press the wrong 10-key pad and want to re-enter.

⚠ If you make a mistake and want to escape without saving any changes made after the last time the **ENTER** key was pressed – press the **STANDBY/OPERATE** key to exit.

⚠ After the **ENTER** key is pressed, the data is entered.

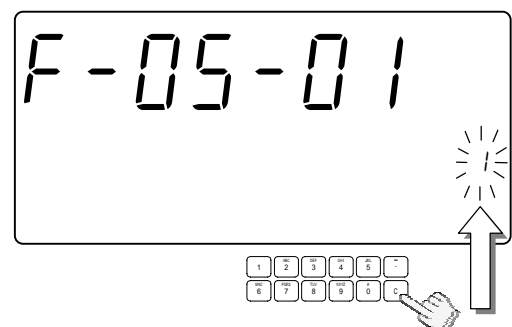

6. Press the **ENTER** key to save any changes and/or move to next.

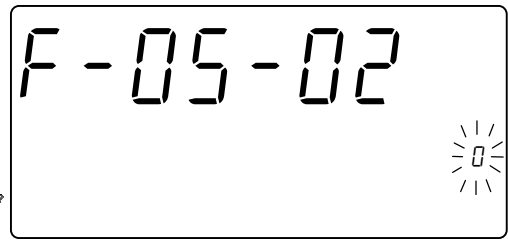
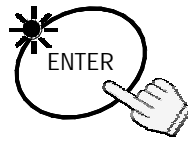

7. When finished: Press the **STANDBY/OPERATE** key to exit. Then, press it to turn the display back on. New settings will operate as set.

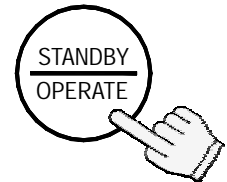

## 9-2. F-Functions

□ “◀” designates factory settings.

### F-00-X Weight Unit

*USA Version ONLY*

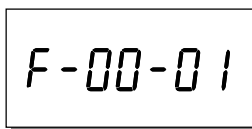

<input type="checkbox"/> <b>Weight Display.</b>	
0	kg (kilograms).
1◀	lb (pounds).

### F-01-X Operations

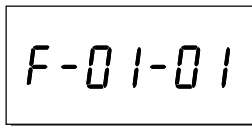

<input type="checkbox"/> <b>Operation Mode.</b>	
0◀	Normal operation. All features and keys available.
1	Simplified operation. Unit weight registration is by sample only. All other keys are disabled.

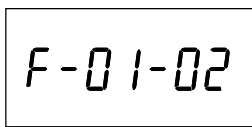

<input type="checkbox"/> <b>“Add” Sample Request Override.</b> If the sample weight is too light and the scale asks to “Add” more sample pieces, using this F-Function, the unit weight can be entered without adding the requested sample pieces. Or disable the “Add” sample request function.	
0	“Add” sample request function is disabled. Light unit weight can be accepted without “Add” more sample request.
1◀	Unit weight <u>can be entered</u> without requested “Add” sample pieces (via the <b>ENTER</b> key).
2	Unit weight <u>cannot be entered</u> without requested “Add” sample pieces (via the <b>ENTER</b> key).

F-01-03

F-01-03 requires OP-05 and a remote scale

<input type="checkbox"/> <b>Auto REMOTE SCALE After Unit Weight Registration.</b>	
The scale can be set to the remote scale after unit weight registration, instead of having to manually press the REMOTE SCALE key. Please note that this does not affect any other use of the REMOTE SCALE key.	
0 ◀	No automatic switching.
1	Automatic switching to the remote scale.
2	Automatic switching to the main scale.

F-01-04

<input type="checkbox"/> <b>Display ON Unit Weight – Reset or Last.</b>	
When the display is turned on, the scale can be set to recall the last unit weight used. Please note that if power is interrupted (such as the AC adapter removed), the last Unit Weight cannot be recalled.	
0 ◀	Unit weight is RESET (cleared) when display comes on.
1	Unit weight last used (before display is turned off, not power interrupt) will be entered automatically.

F-01-05

<input type="checkbox"/> <b>ID Memory Contents.</b>																
The scale ID memory can contain unit weights with tare weights, comparator limits and total count, or just unit weights alone. Item codes are always contained.																
000 ◀	ID memory contains unit weight and item code only.															
<table border="0"> <tr> <td>TOTAL count</td> <td>TARE Weight</td> <td></td> </tr> <tr> <td>↓</td> <td>↓</td> <td></td> </tr> <tr> <td></td> <td></td> <td>000</td> </tr> <tr> <td></td> <td></td> <td>↑</td> </tr> <tr> <td></td> <td></td> <td>Comparator limits</td> </tr> </table>	TOTAL count	TARE Weight		↓	↓				000			↑			Comparator limits	<p>You select which data to be stored by keying in a 0 or 1 for the data: tare weight, comparator limits or total count.</p> <p>Example: Key in 0 1 0 to display 0 10, ID memory contains unit weight including item code and comparator limits.</p>
TOTAL count	TARE Weight															
↓	↓															
		000														
		↑														
		Comparator limits														

F-01-06

F-01-06 requires OP-05 and a remote scale

<input type="checkbox"/> <b>Unit Weight With A 2 Scale System.</b>	
When operating a 2 scale system, the remote scale may have an independent unit weight, or restricted to the same as the main scale.	
0	Each scale can have its own unit weight.
1 ◀	Main and remote scales have the same unit weight only.

## F-02-X ACAI Operation & Min. Unit Weight

F-02-01

<input type="checkbox"/> <b>ACAI Mode When Unit Weight Entered by <i>Sample Pieces</i>.</b>	
0	ACAI is disabled.
1	ACAI automatic operation.
2	ACAI manual mode (using the <b>ENTER</b> key).

F-02-02

<input type="checkbox"/> <b>ACAI Mode When Unit Weight Entered by <i>Keyboard or ID</i></b>	
0	ACAI is disabled.
1	ACAI manual mode (using the <b>ENTER</b> key). This setting works when F-02-01 setting is not "0".
2	ACAI automatic obeys F-02-01 setting.

F-02-03

<input type="checkbox"/> <b>Minimum Unit Weight.</b> (1d=1 weighing display division) The factory setting may be different for some countries.	
0	1/5 d
1	1/100 d

## F-03-X M+ Accumulation Function

F-03-01

<input type="checkbox"/> <b>M+ Accumulation – Automatic or Manual</b>	
0	Manual accumulation (by pressing the <b>M+</b> key).
1	Automatic accumulation (Positive data only).

F-03-02

<input type="checkbox"/> <b>+ or – Count Data Acceptable.</b> (Manual Accumulation)	
0	Positive data only (5d and above).
1	Positive and negative data (5d and above or –5d or below).

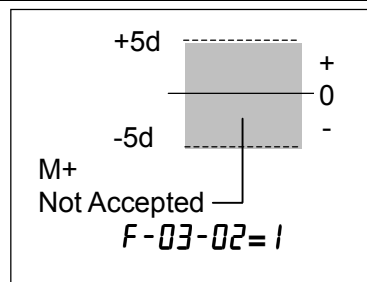
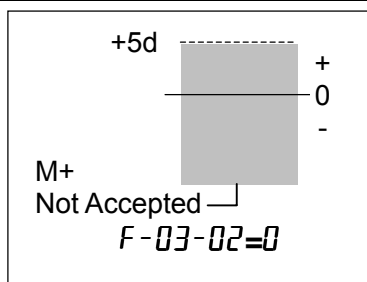

## F-04-X Environment and Beeper

F-04-01

<input type="checkbox"/> <b>Zero Tracking.</b>	
Zero tracking traces a drift from zero caused by temperature changes etc., and stabilizes the zero point.	
0 ◀	Zero tracking ON.
1	Zero tracking OFF.

F-04-02

<input type="checkbox"/> <b>No Operation</b>	
1 ◀	This setting should be "1".

F-04-03

<input type="checkbox"/> <b>Stable Detection Speed / Environment</b>	
0	Fast stable detection (good environment).
1 ◀	Normal.
2	Slow stable detection (poor environment).

F-04-04

<input type="checkbox"/> <b>No Operation</b>	
0 ◀	This setting should be "0".

## F-05-X Comparator

F-05-01

<input type="checkbox"/> <b>Comparator Mode.</b>	
0 ◀	comparator off.
1	compare all data.
2	compare stable data.
3	compare all data except when near zero*.
4	compare stable data except when near zero*.
5	compare all positive data except when near zero*
6	compare stable positive data except when near zero*.
* "near zero" means between -4d and +4d of weight data.	

F-05-02

<input type="checkbox"/> <b>Data to Compare – Count or Weight</b>	
0 ◀	Compare count data.
1	Compare weight data.

<b>F-05-03</b>	<input type="checkbox"/> <b>Upper Limit.</b>	
	0 ◀	Enter via the 10-key pad. Use the <input type="checkbox"/> - or <input type="checkbox"/> . key to “set minus value.”

<b>F-05-04</b>	<input type="checkbox"/> <b>Lower Limit.</b>	
	0 ◀	Enter via the 10-key pad. Use the <input type="checkbox"/> - or <input type="checkbox"/> . key to set minus value.

<b>F-05-05</b>	<input type="checkbox"/> <b>A Beeper With Comparator Results.</b>	
	These are beeps for the comparator, not for the key operation.	
	000 ◀	All Comparator Beepers are OFF.

000	0 = Beeper OFF
↑ ↑ ↑	! = Beeper ON
HI LO	
OK	

**Example:** 

The OK beep sounds – HI & LO doesn't sound. The scale will beep continuously when display meets OK condition.

<b>F-05-06</b>	<input type="checkbox"/> <b>Factory Use.</b>	
	0 ◀	This setting should be “0”.

### F-06-X/F-07-X/F-08-X Data Output

F-06-X for standard RS-232C,  
 F-07-X for Ch.1 (PORT 1) and  
 F-08-X for Ch.2 (PORT 2).

<b>F-<sup>06</sup><sub>07</sub>-01</b>	<input type="checkbox"/> <b>Data Out Mode</b>	
	0 ◀	Key mode: Data is sent by pressing the <input type="button" value="PRINT"/> key. + command mode.
	1	Stream mode: Data is sent continuously. command mode cannot be used.
	2	Auto-print mode A: Data is sent if the weight display is stable at +5d (weighing display division) and above. + command mode.
	3	Auto-print mode B: Data is sent if the weight display is stable, at ±5d (weighing display division) and above/below. + command mode
	4	Command mode only.

F-<sup>06</sup>07-02  
08

<input type="checkbox"/> <b>Data to be Sent.</b>	
00 100 ◀	Count data sent.
Date/Time ID Unit Weight ↓ ↓ ↓ ↓ 00000 ↑ ↑ PCS(count) Weight	You select which data to be sent by keying in a <input type="checkbox"/> 0 or <input type="checkbox"/> 1 for the data: Date, ID no., PCS (count), weight or unit weight. <i>Example:</i> Key in <input type="checkbox"/> 0 <input type="checkbox"/> 1 <input type="checkbox"/> 1 <input type="checkbox"/> 0 <input type="checkbox"/> 0 to display 0 1 00, this setting would send only the ID number and the count.

F-<sup>06</sup>07-03  
08

<input type="checkbox"/> <b>Data Format</b>	
0 ◀	Format for AD-8121 MODE 1.
1	Format for AD-8121 MODE 3.
2	Format for general apparatuses, computers, etc.

F-<sup>06</sup>07-04  
08

<input type="checkbox"/> <b>Baud Rate</b>	
0 ◀	2400 bps.
1	4800 bps.
2	9600 bps.

F-<sup>06</sup>07-05  
08

<input type="checkbox"/> <b>Data Length and Parity</b>	
0 ◀	7 bits, even parity.
1	7 bits, odd parity.
2	8 bits, non parity.

F-09-X  \* key

F-09-01

<input type="checkbox"/> <b>Operation mode for the <input type="checkbox"/> * key</b>	
0 ◀	Operating as a <input type="checkbox"/> MODE key to display comparator upper and lower limits, and time and date.
1	Operating as <input type="checkbox"/> M- key to subtract Count data from M+ memory.



## F-10-X External Control Signal Input

F-10-01

F-10-02

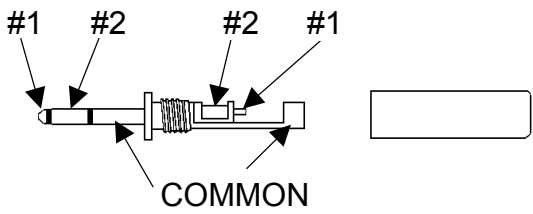
<input type="checkbox"/> <b>Control Signal Input #1 and #2.</b> Select an input (key function) as listed below for each Functions <i>F-10-01</i> and <i>F-10-02</i> . Prepare a 3.5mm stereo jack plug and connect one or two switches to this.	
	
0	Reset <input type="checkbox"/> RESET. (Factory Setting for <i>F-10-01</i> )
1	Enter <input type="checkbox"/> ENTER. (Factory Setting for <i>F-10-02</i> )
2	Tare <input type="checkbox"/> TARE.
3	Zero <input type="checkbox"/> ZERO.
4	Sample <input type="checkbox"/> SAMPLE.
5	Remote Scale <input type="checkbox"/> REMOTE SCALE.
6	Total <input type="checkbox"/> TOTAL.
7	M+ <input type="checkbox"/> M+.
8	Standby / Operate <input type="checkbox"/> STANDBY/OPERATE.
9	Print <input type="checkbox"/> PRINT.

## F-11-X Time & Date

F-11-01

<input type="checkbox"/> <b>Time and Date Display.</b> Select the order of time and date display.	
0	Year-Month-Date.
1	Month-Date-Year.
2	Date-Month-Year.

# 10. ACAI FUNCTION

## 10-1. ACAI Automatic Counting Accuracy Improvement

The ACAI™ (Automatic Counting Accuracy Improvement) function recalculates the unit weight as more pieces are added to improve count accuracy.

When the scale calculates unit weight from sample pieces, the more sample pieces that are used, the higher the accuracy.

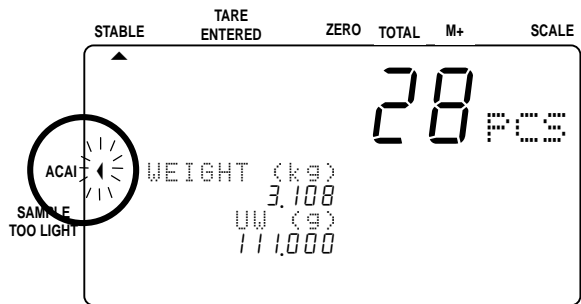

### ACAI Notes

- You must do the ACAI procedure just after you set the unit weight. Samples must be still on the weighing pan.
- Do not take the samples off until the end of the ACAI procedure.
- You don't have to count out the pieces when you add, just stay within the ACAI range.
- Continue the ACAI procedure to reach the largest amount that you will be counting.
- If you want the most precise counting results for every different batch of the same items, use ACAI every time you start counting the next batch.
- The ACAI does not work when you use a remote scale if the unit weight was set on the main scale and vice versa.
- The ACAI function is initially set to manual operation when the unit weight is set digitally by the keyboard, by ID memory or using computer via the serial interface. This can be set to the automatic mode. The ACAI mode when unit weight is entered by ID or digital input is controlled by F-Function *F-02-02*. It is initially set at "0", ACAI manual operation mode. Set to "1" for automatic operation mode.

## 10-2. ACAI Automatic Operation

1. To start ACAI automatic operation, unit weight must be registered and the sample still on the weighing pan.

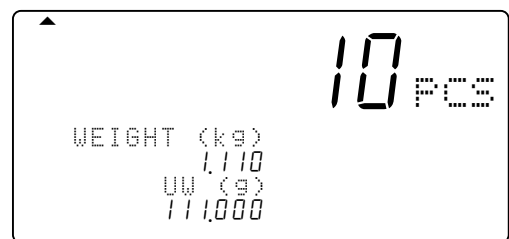
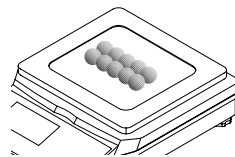

2. Add pieces within the nearest ACAI range (refer to table below). A good rule of thumb is to roughly double the amount on the weighing pan.

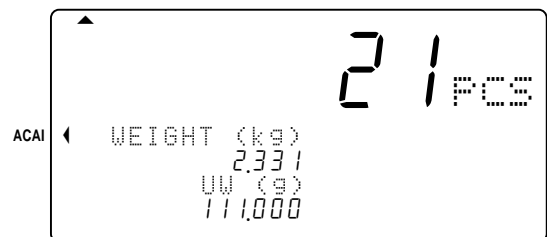
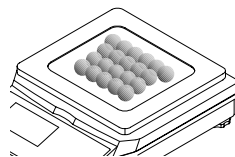

Pcs On the Weighing Pan	ACAI Addition Range		
10	13~27	60	63~123
20	23~50	70	73~139
30	33~71	80	83~153
40	43~90	90	93~167
50	53~107	100	103~300
		over 200	203~493

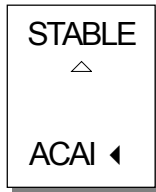

As you add, the ACAI indicator will be ON as long as you are in range.

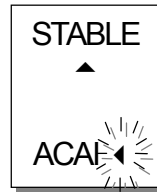

When you stop adding and the display becomes STABLE, the ACAI indicator will blink.

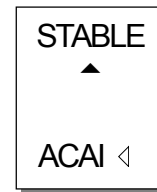

After the new unit weight is calculated, the indicator will disappear,

- Continue adding pieces within the ACAI range until you have reached a sample size as large as the largest number of pieces that you will be counting.
- When you have added the maximum number of pieces required, remove the sample pieces and start your counting job.

### 10-3. ACAI Manual Operation

- The ACAI procedure can also be controlled manually. The ACAI will not recalculate unit weight until the **ENTER** key is pressed (as long as it is at the proper time and the guidelines in the ACAI notes have been followed).
- The ACAI manual mode is controlled by F-Function *F-02-01*, set at "1".
- To start ACAI manual operation, unit weight must be registered and the sample still on the weighing pan.

- Add pieces within the nearest ACAI range (refer to table in the previous section). The ACAI indicator will stay ON as long as you are in ACAI range.

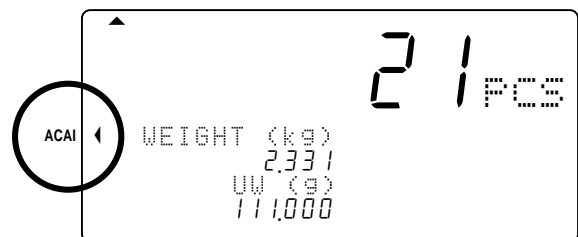

- Wait until the display becomes stable and press the **ENTER** key. When the new unit weight is calculated, the indicator will blink for a moment and disappear.
  - Continue adding pieces within the ACAI range until you have reached a sample size as large as the largest number of pieces that you will be counting.
- When you have added the maximum number of pieces required, remove the sample pieces and start your counting job.

# 11. RS-232C SERIAL INTERFACE

- ❑ The FC-*i* scale has not only a standard RS-232C interface but also optional interfaces, Ch.1 and Ch.2.
- ❑ The specifications described in this section are common to all of the RS-232C interfaces.

## 11-1. RS-232C Specifications

Transmission system	EIA RS-232C
Transmission form	Asynchronous, bi-directional, half-duplex
Data format	Baud rate: 2400, 4800, 9600 bps
	Data: 7 bits + parity 1bit (even or odd) or 8 bits (non-parity)
	Start bit: 1 bit
	Stop bit: 1 bit
	Code: ASCII
	Terminator: Data Send / C <sub>R</sub> L <sub>F</sub> (C <sub>R</sub> : 0Dh, L <sub>F</sub> : 0Ah) Data Receive / C <sub>R</sub> or C <sub>R</sub> L <sub>F</sub>

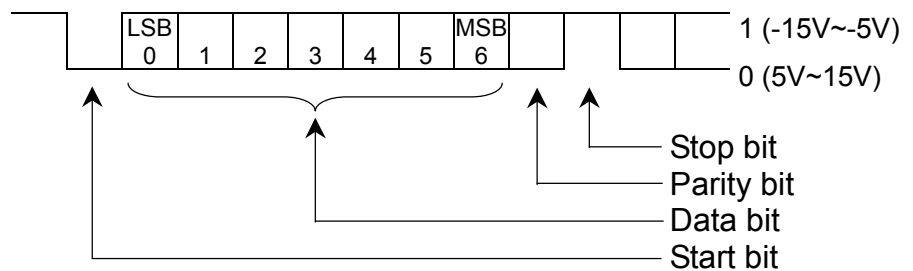

### Pin connections

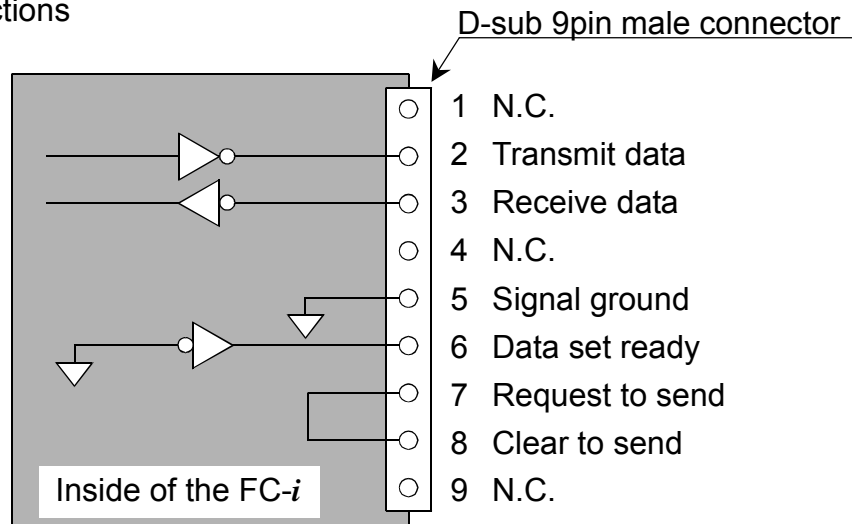

- ❑ The FC-*i* scales is designated as DCE (Data Communication Equipment).

## 11-2. Data Output Mode

- ❑ The data output modes and parameters are set by F-Functions in *F-06 / 07 / 08-X* as described in the F-Function parameters, section 9.
- ❑ To control the scale using commands from an external device, refer to “11-5. Command Mode”.
- ❑ Refer to “11-5. Command Mode” about the output data format.

### Data Out Mode (*F-06 / 07 / 08-0 1*)

- ❑ Key Mode (*F-06 07 08-0 1="0"*)  
When the weight display is stable, data is sent by pressing the PRINT key. The count display will blink when the data has been sent.
- ❑ Stream Mode (*F-06/07/08-0 1="1"*)  
Data is sent continuously. The data-update rate is approximately 10 times per second for *F-06/07/08-03="2"*. This rate is same as the display-update rate. For *F-06/07/08-3="1"* or "2", the interval between continuous data is approximately 1.6 seconds.
- ❑ Auto-print Mode A (*F-06/07/08-0 1="2"*)  
Data is sent if the WEIGHT display is stable at +5d (weighing display division) and above. Next transmission can not occur until after the weight display falls below +5d.
- ❑ Auto-print Mode B (*F-06/07/08-0 1="3"*)  
Data is sent if the WEIGHT display is stable at ±5d (weighing display division) and above/below. Next transmission can not occur until after the weight display falls between -5d and +5d.

### Data to be Sent (*F-06 / 07 / 08-02*)

Select which data is to be sent by keying in a 0 or 1 for the data: Date / time, ID No., PCS (count), weight or unit weight.

*Example:* Key in 0 1 1 0 0 to display 0 1 1 0 0, this setting would send only the ID number and the count.

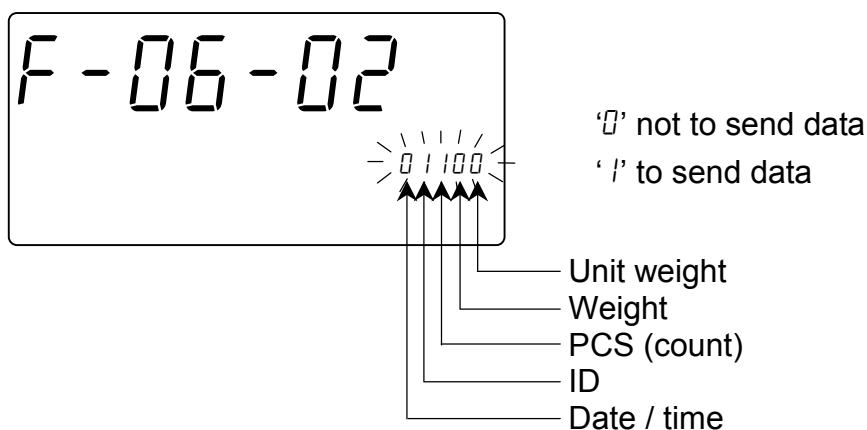

## Data Format (F-06/07/08-03)

- Format for AD-8121 MODE 1 or 2. (F-06/07/08-03="0")
- Format for AD-8121 MODE 3. (F-06/07/08-03="1")
- Format for general apparatuses, computers, etc. (F-06/07/08-03="2")

## Baud Rate (F-06/07/08-04)

Select the baud rate according to the device to be connected.

- 2400 bps (F-06/07/08-04="0") Select 2400 bps to connect with an AD-8121.
- 4800 bps (F-06/07/08-04="1")
- 9600 bps (F-06/07/08-04="2")

## 11-3. Connecting the AD-8121 Printer / MODE 1 or MODE 2

- When using the AD-8121 printer (MODE1 or MODE 2), you will be able to get data: Number of data items, total, maximum, minimum, mean value, range of data (max. - min. data) and standard deviation.
- When using the AD-8121 with MODE 2, set F-06/07/08-02 to print pcs (count) data only or Weight data only.
- To print date and time, use the AD-8121's calendar / clock function and set F-06/07/08-2 to print pcs (count) data only or Weight data only.

## Print Operations Settings

Print By:	F-Function F-06/07/08-01	Printer MODE
FC <input type="button" value="PRINT"/> key	0	MODE 1
Auto Print	2 or 3	MODE 1
Printer <input type="button" value="DATA"/> key	1	MODE 2

## Example of F-06/07/08-02 settings

- To print pcs (count) data only: set F-06/07/08-02 at "00 100"
- To print weight data only: set F-06/07/08-02 at "000 10"
- To print pcs (count) and weight data: set F-06/07/08-02 at "00 1 10"
- To print pcs, weight and Unit Weight data: set F-06/07/08-02 at "00 1 1 1"
- To print total data (accumulated by the  key), press the  key so the Count display shows the total, then press the  key.
- If you are using the AD-8121's statistic functions, then set F-06/07/08-02 at "00 1#0" (# = 0 or 1) for pcs (count) data or "000 10" for weight data.
- MODE 1 and 2 of the AD-8121 can not print ID numbers.

## 11-4. Connecting the AD-8121 Printer / MODE 3

- When using MODE 3 of the AD-8121 printer, printouts are obtained using the  key (F-06/07/08-01 = 0), or auto-print mode A/B (F-06/07/08-01 = 2 or 3).
- MODE 3 can print the ID number with its item code.

- ❑ To print date/time, set *F-06/07/08-02* at "#####" (# = 0 or 1).
- ❑ The total data (accumulated by the **M+** key) will be printed along with the number of additions to **M+** memory.
- ⚠ The AD-8121 / MODE 3 does not have statistical functions.

## AD-8121 Printout Sample

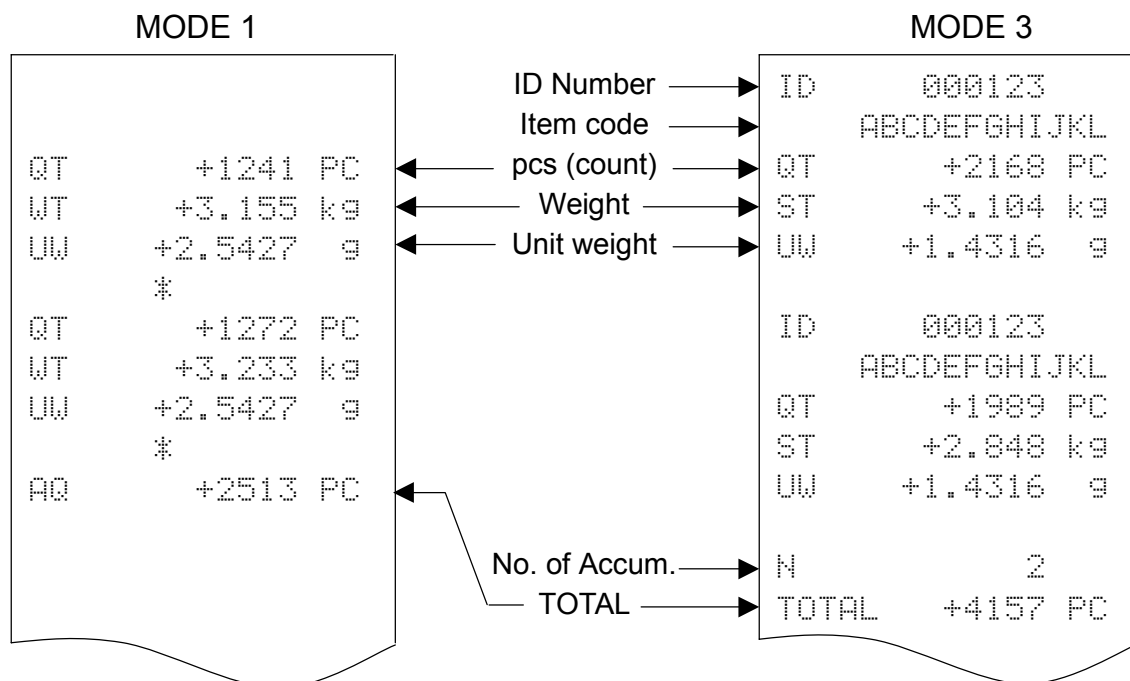

## 11-5. Command Mode

- ❑ In the command mode, the scale is controlled by commands that come from an external device, computer etc.
- ⚠ Do not set *F-06/07/08-01*="1" (stream mode) to use with the command mode. if you don't want to use command mode together with key mode or auto-print mode, set *F-06/07/08-01*="4" (command mode only).
- ❑ Use a D-sub 9 pin cable (straight type) to connect with a computer.

### Command List

Command	Definition	Notes
@	Start / stop continuous data transmission.	
A	Same as <b>RESET</b> key.	Key command
D	Set a known tare weight.	"D,1.23C <sub>R</sub> L <sub>F</sub> " sets the tare weight as "1.23kg".
E	Store the unit weight in use, other values and specified item code to ID memory.	Refer to the data format. Refer <i>F-01-05</i>
F	Recall unit weight from ID memory.	"F123C <sub>R</sub> L <sub>F</sub> " recalls from ID000123.

Command	Definition	Notes
G	Set a known unit weight.	"G,0.123C <sub>R</sub> L <sub>F</sub> " sets the unit weight as "0.123kg" (or "0.123 lb").
I	Same as the <b>REMOTE SCALE</b> key.	Key command
J	Same as the <b>TOTAL</b> key.	
K	Same as the <b>M+</b> key.	
P	Same as the <b>STANDBY/OPERATE</b> key.	Key command
Q	Send data immediately.	Data depends on
S	Send stable data after accepting command.	<i>F-06/07/08-02</i>
T	Same as the <b>TARE</b> key.	Key command
X	Request a list of the F-Function parameters.	The last data terminates with <EOT> (04H)
Y	Request a list of the ID memory contents.	
Z	Same as the <b>ZERO</b> key.	Key command
ON	Turn the display ON.	
OFF	Turn the display OFF.	
?ID	Send the ID number and item code in use.	Refer to the data format for the reply.
?QT	Send the pcs (count) data.	
?WT	Send the weight data.	
?UW	Send the unit weight in use.	
?AQ	Send the total (accumulated) <b>M+</b> memory count	
?AN	Send the number of additions to <b>M+</b> memory.	
?TR	Send the tare weight in use.	
?MR	Send the specified ID memory contents.	
MR	Store the unit weight and tare weight into the specified ID memory.	
MI	Store item code into specified ID memory.	
ML	Store the comparator limits into the specified ID memory.	
MA	Store the total count and number of additions into the specified ID memory.	
CM	Clear the specified ID memory contents	
?FC	Send the specified F-Function setting.	Refer to the data format for the reply.
FC	Store the specified F-Function setting value.	



## Acknowledgment and Error Codes

When the FC-*i* scales receives an external command, it reacts as follows:

- ❑ If the command requests a data reply, the scale will send the data.  
For other commands, the scale will send an acknowledgment <AK> (06H) upon acceptance of the command.
- ❑ If the command is **[S]**, **[T]** or **[Z]**, the scale will send a second acknowledgment <AK> (06H) when the command operation is completed.

If an error occurs, the scale will send an error code.

- ❑ The error format is **[E][C], [E]n [C<sub>R</sub>][L<sub>F</sub>]** , "n" being the error number.

En	Definition	Notes
E0	Communication error	Parity error, framing error, etc.
E1	Undefined command error	The command does not exist for the FC- <i>i</i> scales.
E2	Scale not ready error.	The scale is not in a state where a command could be expected.
E4	Too many characters error	The command contains too many characters.
E6	Format error	The command contains invalid characters.
E7	Out of range error	Value is out of range. The tare weight is more than the capacity, etc.

## Data Format " \_ " in examples below shows "Space" (20H).

- ❑ Store the unit weight in use, other values (according to *F-0 1-05*) and specified item code

Command **[E], [1][2][3][C<sub>R</sub>][L<sub>F</sub>]** Stores into *d000 123* with no item code.  
**[E], [1][2][3], [a][b][c][C<sub>R</sub>][L<sub>F</sub>]** Stores into *d000 123* with item code "abc" .  
 Reply **[AK]**

- ❑ ID number and item code

Command **[?][I][D][C<sub>R</sub>][L<sub>F</sub>]**  
 Reply **[I][D], [0][0][0][1][2][3][C<sub>R</sub>][L<sub>F</sub>][A][B][C][D][E][F][G][H][I][J][K][L][C<sub>R</sub>][L<sub>F</sub>]**  
} ID number } Item code (These are "space" for no item code.)

- ❑ PCS (Count ) data

Command **[?][Q][T][C<sub>R</sub>][L<sub>F</sub>]**  
 Reply **[Q][T], [+][0][0][0][0][1][2][3][4][\_][P][C][C<sub>R</sub>][L<sub>F</sub>]** Stable positive data  
**[U][S], [-][0][0][0][0][5][6][7][8][\_][P][C][C<sub>R</sub>][L<sub>F</sub>]** Unstable negative data  
**[O][L], [+][9][9][9][9][9][9][9][9][\_][P][C][C<sub>R</sub>][L<sub>F</sub>]** "E" display

Weight data

Command 

?	W	T	C <sub>R</sub>	L <sub>F</sub>
---	---	---	----------------	----------------

Reply

S	T	,	+	0	0	1	.	2	3	4	6	└	k	g	C <sub>R</sub>	L <sub>F</sub>
S	T	,	-	0	0	2	.	7	2	5	5	└	l	b	C <sub>R</sub>	L <sub>F</sub>
U	S	,	-	0	0	1	2	.	3	4	6	└	l	b	C <sub>R</sub>	L <sub>F</sub>
U	S	,	+	0	0	0	5	.	5	9	3	└	k	g	C <sub>R</sub>	L <sub>F</sub>
O	L	,	+	9	9	9	9	.	9	9	9	└	k	g	C <sub>R</sub>	L <sub>F</sub>
O	L	,	-	9	9	9	9	.	9	9	9	└	l	b	C <sub>R</sub>	L <sub>F</sub>

Stable positive data  
Stable negative data  
Unstable negative data  
Unstable positive data  
"E" display  
"-E" display

Unit weight

Command 

?	U	W	C <sub>R</sub>	L <sub>F</sub>
---	---	---	----------------	----------------

Reply

U	W	,	+	1	.	2	3	4	5	6	7	└	└	g	C <sub>R</sub>	L <sub>F</sub>
U	W	,	+	0	.	2	7	2	5	3	1	└	l	b	C <sub>R</sub>	L <sub>F</sub>

Total count

Command 

?	A	Q	C <sub>R</sub>	L <sub>F</sub>
---	---	---	----------------	----------------

Reply

A	Q	,	+	0	0	9	9	9	9	9	9	└	P	C	C <sub>R</sub>	L <sub>F</sub>
---	---	---	---	---	---	---	---	---	---	---	---	---	---	---	----------------	----------------

Accumulation number

Command 

?	A	N	C <sub>R</sub>	L <sub>F</sub>
---	---	---	----------------	----------------

Reply

A	N	,	0	0	0	0	1	2	3	4	C <sub>R</sub>	L <sub>F</sub>
---	---	---	---	---	---	---	---	---	---	---	----------------	----------------

Tare weight

Command 

?	T	R	C <sub>R</sub>	L <sub>F</sub>
---	---	---	----------------	----------------

Reply

T	R	,	+	0	0	1	.	2	3	4	6	└	k	g	C <sub>R</sub>	L <sub>F</sub>
---	---	---	---	---	---	---	---	---	---	---	---	---	---	---	----------------	----------------

Request the FC-i scales to reply with the contents of ID memory.

Command 

?	M	R	,	1	2	3	C <sub>R</sub>	L <sub>F</sub>
---	---	---	---	---	---	---	----------------	----------------

 Request the contents of *id000123*.

Reply

M	R	,	0	0	0	1	2	3	,	a	b	c	d	e	f	g	h	i	j	k	l	,
1	2	.	3	4	5	6	7	,	+	0	0	0	.	2	3	4	5	,	+	0	0	0
0	1	3	5	7	,	+	0	0	0	0	1	2	4	6	,	+	0	1	2	3	4	5
6	7	,	0	0	0	0	1	2	3	4	C <sub>R</sub>	L <sub>F</sub>										

MR, ID number (6 digit), item code (12 digits), unit weight (8 digits including decimal point), tare weight (9 digits including sign and decimal point), upper limit (9 digits including sign), lower limit (9 digits including sign), total count (9 digits including sign), number of additions (8 digit) C<sub>R</sub> L<sub>F</sub>.

Command	?	M	R	C <sub>R</sub>	L <sub>F</sub>	Request the contents of the <u>next ID</u> .																	
Reply	M	R	,	0	0	0	1	2	4	,	A	B	C	D	E	F	G	H	I	J	K	L	,
	2	3	.	4	5	6	7	8	,	+	0	0	0	.	2	3	4	5	,	+	0	0	0
	0	1	3	5	7	,	+	0	0	0	0	1	2	4	6	,	+	0	2	3	4	5	6
	7	8	,	0	0	0	0	2	3	4	5	C <sub>R</sub>	L <sub>F</sub>										

- Store the unit weight and tare weight into a specified ID memory.

Command	M	R	,	1	2	3	,	1	.	2	3	,	0	.	3	4	5	C <sub>R</sub>	L <sub>F</sub>
				ID #			Unit weight			Tare weight									

Reply AK

ID number: Maximum 6 digit  
 Unit weight: Maximum 8 digit including decimal point  
 Tare weight: Maximum 8 digit including decimal point ("kg" or "lb" depends on F-00 setting).

- Store the item code into a specified ID memory.

Command	M	I	,	1	2	3	,	a	b	c	d	C <sub>R</sub>	L <sub>F</sub>
				ID #			Item code						

Reply AK

ID Number: Maximum 6 digit  
 Item Code: Maximum 12 digit  
 The example above is stored as "a b c d \_\_\_\_\_"  
 " a b c d \_\_\_\_\_"

- Store the comparator limits into a specified ID memory.

Command	M	L	,	1	2	3	,	+	1	0	1	0	,	+	9	9	0	C <sub>R</sub>	L <sub>F</sub>
				ID #			Upper Limit					Lower Limit							

Reply AK

ID number: Maximum 6 digit  
 Upper limit: Maximum 9 digit including sign  
 Lower limit: Maximum 9 digit including sign

- Store the total count and number of additions into a specified ID memory.

Command	M	A	,	1	2	3	,	+	6	7	8	9	,	+	1	2	3	C <sub>R</sub>	L <sub>F</sub>
				ID #			Total Count					# of Additions							

Reply AK

ID number: Maximum 6 digits  
 Total count: Maximum 9 digits including sign  
 Lower limit: Maximum 8 digits

- Request the FC-*i* scales to reply with the F-Function settings.

Command 

?	F	C	,	0	5	0	1	C <sub>R</sub>	L <sub>F</sub>
---	---	---	---	---	---	---	---	----------------	----------------

 Request the setting of F-05-01.

Reply 

F	C	,	0	5	0	1	,	0	C <sub>R</sub>	L <sub>F</sub>
---	---	---	---	---	---	---	---	---	----------------	----------------

 F-05-01 = 0

F-#
Setting value

Command 

?	F	C	C <sub>R</sub>	L <sub>F</sub>
---	---	---	----------------	----------------

 Request to reply with the setting of the next F-Function.

Reply 

F	C	,	0	5	0	2	,	0	C <sub>R</sub>	L <sub>F</sub>
---	---	---	---	---	---	---	---	---	----------------	----------------

 F-05-02 = 0

- Store the specified F-Function setting value

Command 

F	C	,	0	5	0	3	,	+	1	2	3	4	C <sub>R</sub>	L <sub>F</sub>
---	---	---	---	---	---	---	---	---	---	---	---	---	----------------	----------------

 Set "1234" as the Upper limit.

F-#
Setting value

F-Function number: 4 digits

Setting value: Maximum 8 digits including sign.

Reply 

AK
----

Command 

O	N	C <sub>R</sub>	L <sub>F</sub>
---	---	----------------	----------------

Start with new settings.

Reply 

AK
----

- ⚠ Having finished the "FC" command, send the "ON" command to start the scale with new settings. The scale replies <AK> (06H) and starts.

# 12. OPTIONS

## 12-1. OP-02 Ni-MH Battery Pack

### Using OP-02 Battery Pack

- By using the OP-02 Ni-MH battery pack, the scale can be operated for around 10 hours, after a full charge and using no other options.
1. After making sure that the battery switch on the battery pack is "OFF" position, insert the battery pack firmly into the rear side of the scale.

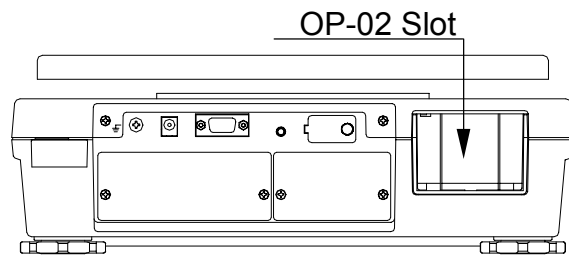
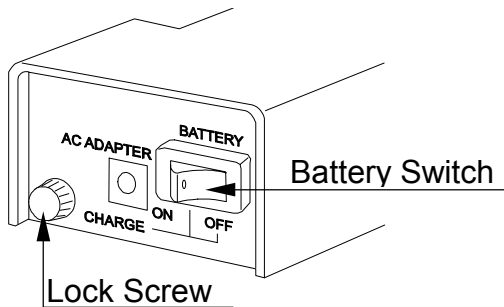

2. Tighten the lock screw on the battery pack.
3. When desired, turn the battery switch on to supply power to the scale. The display will come on after its self-check.

4. Use the **STANDBY/OPERATE** key to turn the display on or off. When the scale is in standby mode, a period appears in the weight display as an indicator.

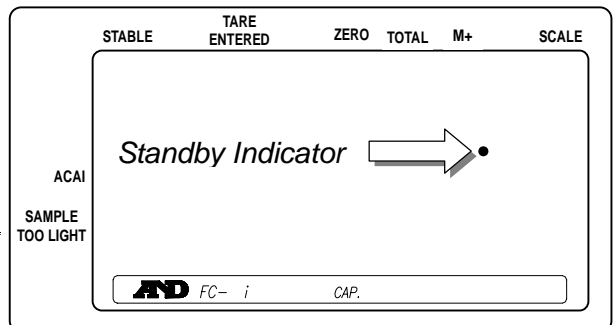
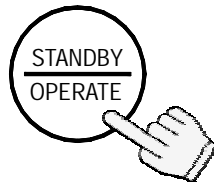

⚠ When the weight display shows "Lo bAt" for low battery, the battery power is almost exhausted and should be recharged.

⚠ Before getting to low battery, the display will show "Lo bAt" on and off to indicate that the battery power is coming close to low battery.

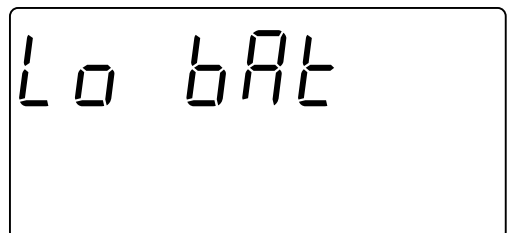

The **STANDBY/OPERATE** key only turns the display on or off (and keeps the scale warmed up on standby). When the scale is not used for a long periods, switch the battery switch to "OFF" position.

## Recharging the Battery

1. Turn the battery switch off on the battery pack.
2. Fully loosen the lock screw and remove the battery.
  - If you want to recharge the battery while it is still in the scale, you may do so. In that case, disregard step 2 – but do not turn the battery switch on. If you wish to use the scale, connect another AC adapter.
3. Connect the AC adapter to the battery pack.
  - The battery pack will take about 15 hours to fully charge.
  - Charge the battery pack at a temperature between 0°C (32°F) and 40°C (104°F).
  - Do not charge too long as overcharging will reduce the life of batteries.
  - Be sure to charge the battery pack when using for the first time or if it was not used for long time (more than one month). Two or three times of recharging may be needed to reach full charge.
  - Be sure to use the AC adapter that is provided with the FC-*i* scales.

Battery switch	AC Adapter to battery pack	AC Adapter to scale	Charge	Scale operation
ON or OFF	Connected	Connected	Yes	Operational
ON or OFF	Not connected	Connected	No	Operational
OFF	Connected	Not connected	Yes	Not operational
ON	Connected	Not connected	No	Not recommended (See note)

**Note** The scale will be operational. After connecting the AC adapter to the battery pack, you may have to turn the battery switch OFF once and turn it ON to operate the scale.

## 12-2. OP-03 2 Ch. RS-232C

Multiple RS-232C interfaces expanding your counting applications are obtained by installing OP-03.

### OP-03 Installation

1. Disconnect the AC adapter from the scale.
2. Remove the two screws and panel covering the OP-03/04 slot.
3. Connect the connector in the FC-*i* scales to the OP-03 unit.
4. Secure the OP-03 unit using the screws removed in the step 2 above.

- Specifications are same as the standard RS-232C interface and refer to “11. RS-232C SERIAL INTERFACE”.

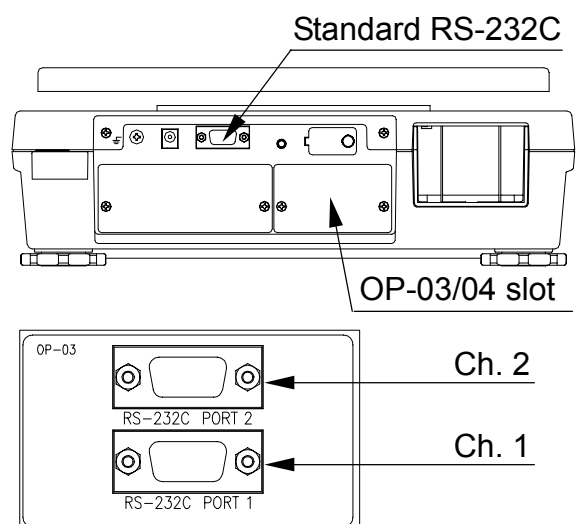

## 12-3. OP-04 RS-232C and Comparator Relay Output

Multiple RS-232C interfaces and relay output for the comparator results are obtained by installing OP-04.

### OP-04 Installation

- See the OP-03 installation.
- OP-04 is installed to the same slot as option OP-03.
- The RS-232C specifications are same as the standard RS-232C interface. Refer to "11. RS-232C SERIAL INTERFACE".

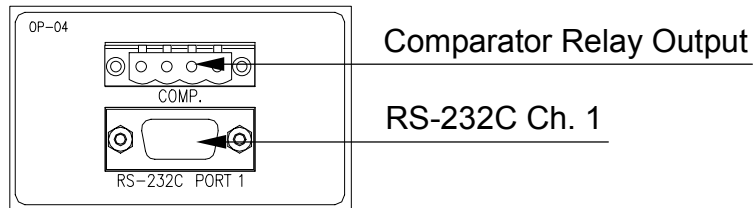

### Comparator Relay Output Circuit

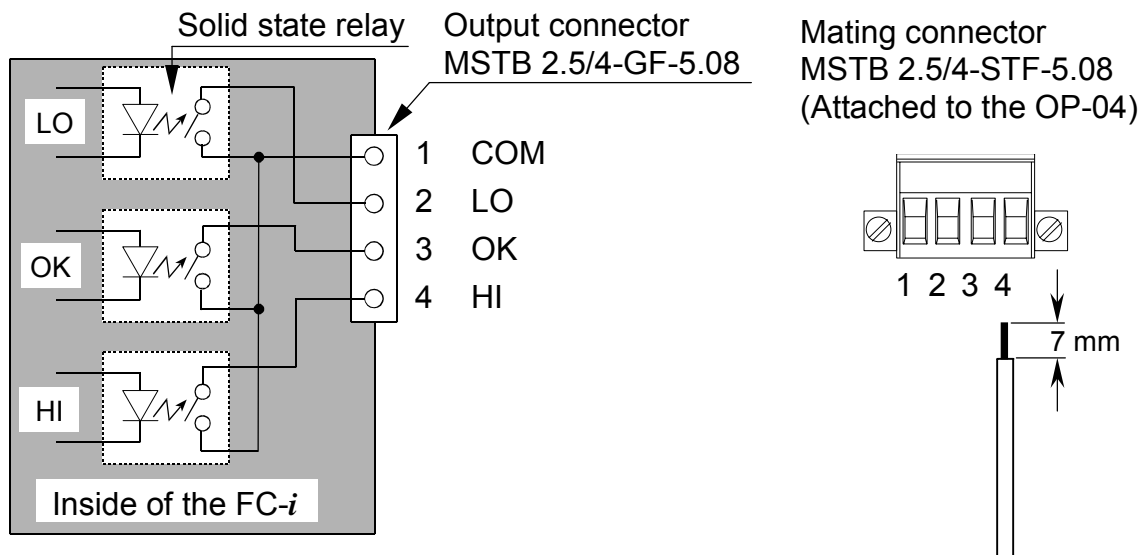

### Maximum rating of the Relay Output

The maximum rating of the replay output is as follows.

- Maximum voltage: 50V DC
- Maximum current: 100mA DC
- Maximum ON resistance: 8Ω

## 12-4. OP-05 Remote Scale Interface

A two-scale system using the FC-*i* scales is possible by installing OP-05 and connecting a remote scale. You can use any load cell platform that meets the conditions in this section.

### OP-05 Installation

1. Disconnect the AC adapter from the scale.
  2. Remove the two screws and panel covering the Remote scale slot.
  3. Connect the connector in the FC-*i* scales to the OP-05 unit.
  4. Secure the OP-05 unit using the screws removed in the step 2 above.
- If you are not using the remote scale for the moment, attach the protective screw cap to the remote scale connector.

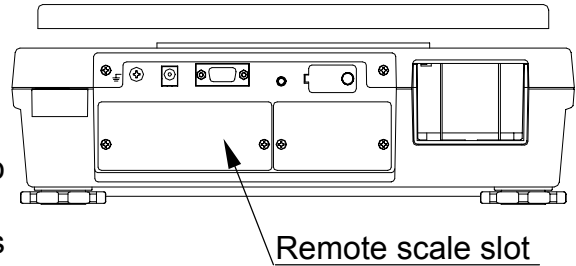

### Notes on Using the Remote Scale

- To get a highly accurate counting unit weight, use the main scale to register unit weight and use ACAI feature. After registration, switch to the remote scale to count.
- If F-01-03 is set at "1", then the scale will automatically switch to the remote scale after unit weight (by sample pieces) is registered by the main scale. Pressing the **SAMPLE** key will always return to the main scale.
- Be aware that both the main and remote scales have separate tare values. So, if you want to use a tare container on both, it must be tared on both.
- F-Function F-01-06 can be set so the remote scale has an independent unit weight, or is restricted to the same as the main scale.

### Specifications for Remote Scale

The FC-*i* scales has the ability of driving up to 4 load cells (350Ω) in a remote scale (platform). Set for the capacity range 0.5kg to 5,000kg (1 lb to 10,000 lb).

- The FC-*i* scales has the ability of driving up to 4 load cells (350Ω) in a remote scale (platform).
- Capacity range** for the remote scale is 0.5kg to 5,000kg (1 lb to 10,000 lb).
- Minimum output** at zero point is 1mV.
- Maximum output** at full load is 14mV.
- Excitation Voltage** of the scale is 5V.
- Cable length** should be kept under 5m (16.5 ft.) for higher accuracy.
- Pin connection** (JM:NJC-207-PF):

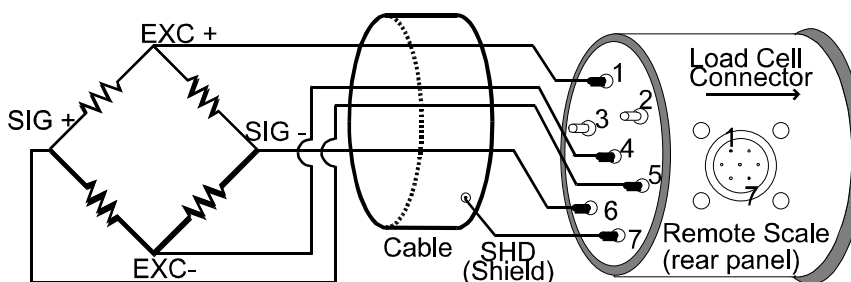



## The Load Cell and Input Sensitivity

The relationship between load cell and input sensitivity ( $X$ ) for the FC- $i$  scales is:

- |                          |         |                           |        |     |
|--------------------------|---------|---------------------------|--------|-----|
| <input type="checkbox"/> | Example | Load Cell Capacity        | 100kg  | "A" |
|                          |         | Rated Output              | 3mV/V  | "B" |
|                          |         | Min., Division of Display | 0.01kg | "D" |
- When a single Load Cell is used, the following formula should apply:
- $$"X" = \frac{5,000 \times B \times D}{A} \mu V$$
- System design will be satisfactory if " $X$ " is greater than  $0.5\mu V$ . In the example above
- $$"X" = 1.5\mu V.$$

## Capacity and Resolution

- The resolution of the remote scale is automatically determined during the calibration procedure. The following is to enable you to calculate the resolution for a given capacity.
1. Decide the capacity value and assign it to " $Ws$ ". Maximum 5 digits.
  2. Get the maximum count " $Ns$ " for the capacity. Ignore the decimal point and add "0" to  $Ws$  until it is 5 digits.
  3. Calculate:  $d' = Ns/10,000$ .
  4. Decide the minimum division " $d$ ".
    - $d' = 1 \rightarrow d = 1$
    - $2 \geq d' > 1 \rightarrow d = 2$
    - $5 \geq d' > 2 \rightarrow d = 5$
    - $d' > 5 \rightarrow d = 10$  This should be changed to  $d = 1$ , dividing  $Ns$  by 10.
  5. Now " $Ns \times d$ " and the resolution  $1/No = d/Ns$  can be determined.

Step	Parameters	Example 1	Example 2	Example 3
1	$Ws$	200kg	30.0kg	600kg
2	$Ns$	20,000	30,000	60,000
3	$d'$	2	3	6
4	$d$	2 (=0.02kg)	5 (=0.005kg)	10 (=0.1kg)
5	$Ns \times d$	20,000 x 2	30,000 x 5	6,000 x 1
	$1/No (=d/Ns)$	1/10,000	1/6,000	1/6,000

6. Calculate the voltage sensitivity " $Es$ ".
  - $Es = (As - Ao) \times 5,000 \times 1/No (\mu V)$  [5,000 means excitation voltage 5V]
  - $Ao$ : Load cell output at zero point (mV/V)
  - $As$ : Load cell output at full capacity (mV/V)
7. Check the voltage sensitivity " $Es$ ".
  - $Es \geq 0.5\mu V \rightarrow$  Calculated " $Ns \times d$ " is fixed. In example 3 in the step 5, a 600kg x 0.1kg scale will be obtained.
  - $Es < 0.5\mu V \rightarrow$  Change " $d$ " for new resolution  $1/No$ .
    - $d = 1 \rightarrow 2$
    - $d = 2 \rightarrow 5$
    - $d = 5 \rightarrow 10 \rightarrow 1$  (dividing " $Ns$ " by 10)
  - In example 1,
    - the new  $d = 5$ :  $1/No = d/Ns = 5/20,000 = 1/4,000$  (200kg x 0.05kg)
  - In example 2,
    - the new  $d = 1$  and  $Ns = 3,000$ :  $1/No = d/Ns = 1/3,000$  (30kg x 0.01kg)
  - Using the new  $1/No$ , go to step 6 and repeat it until  $Es \geq 0.5\mu V$  in step 7.

## Remote Scale kg/lb relationship

USA Version ONLY

- When the capacity was set by “kg”:  
 Let capacity x minimum division =  $W_s \times W_d$  (kg)  
 When:  
    $d = 1$ , then  $W_d$  (lb) =  $W_d$  (kg) x 2  
    $d = 2$ , then  $W_d$  (lb) =  $W_d$  (kg) x 5/2  
    $d = 5$ , then  $W_d$  (lb) =  $W_d$  (kg) x 2  
 And:  
    $W_s$  (lb) =  $W_d$  (kg) x No  
 Example:  $15\text{kg} \times 0.002\text{kg}$ ,  $No = 15\text{kg}/0.002\text{kg} = 7,500$   
            $W_d$  (lb) =  $0.002 \times 5/2 = 0.005$  (lb)  
            $W_s$  (lb) =  $0.005$  (lb) x  $7,500 = 37.5$  (lb)
- When the capacity was set by “lb”:  
 Let capacity x minimum division =  $W_s \times W_d$  (lb)  
 When:  
    $d = 1$ , then  $W_d$  (kg) =  $W_d$  (lb) x 1/2  
    $d = 2$ , then  $W_d$  (kg) =  $W_d$  (lb) x 1/2  
    $d = 5$ , then  $W_d$  (kg) =  $W_d$  (lb) x 2/5  
 And:  
    $W_s$  (kg) =  $W_d$  (lb) x No  
 Example:  $30\text{lb} \times 0.005\text{lb}$ ,  $No = 30\text{lb}/0.005\text{lb} = 6,000$   
            $W_d$  (kg) =  $0.005 \times 2/5 = 0.002$  (kg)  
            $W_s$  (kg) =  $0.002$  (kg) x  $6,000 = 12$  (kg)

## Calibrating the Remote Scale

- ⚠ When a remote scale is newly connected, set the capacity and calibrate the scale using a weight.
- ⚠ The scale must be warmed up (plugged in) for at least 30 minutes before starting calibration.

1. Remove the calibration switch cover, and press the calibration **CAL** switch.  
The scale shows “CAL” in the count display.

- Press the **CAL** switch to exit without calibrating the scale.

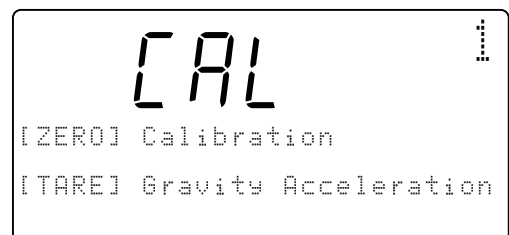

2. Press the **REMOTE SCALE** key to display SCALE “2”.

SCALE “1”: Main Scale  
 SCALE “2”: Remote Scale

- ⚠ When SCALE “1” is displayed, press the **REMOTE SCALE** key again.



- Once the remote scale has been calibrated, the display will go to step 4.

3. Use the [0] → [9] and [.] 10-key pad to display the desired capacity.  
(Example of capacity 2000kg)

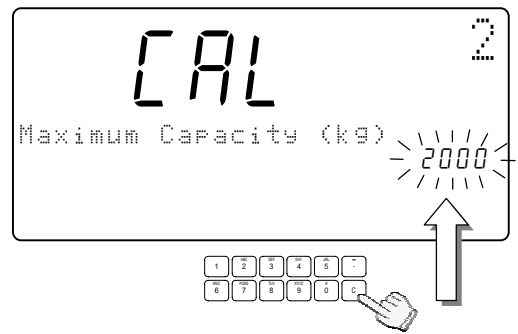

4. Press the [ENTER] key.  
The capacity value stops blinking.

- When the remote scale has been changed or to change capacity, go back to step 3.

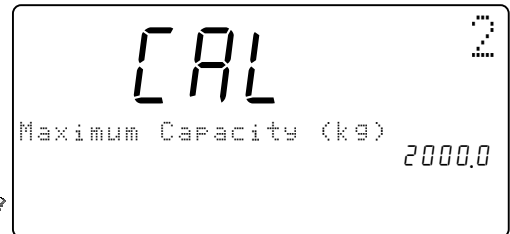
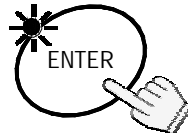

5. Press the [ENTER] key again to store the capacity entered and the remote scale is ready to be calibrated.

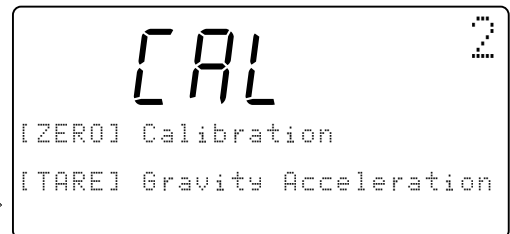
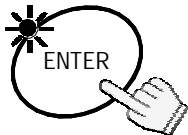

6. Go to step 2 in section “8-1. Calibration Procedure Using a Weigh” to calibrate the remote scale.

---

# ADDENDA

---

## FC-*i* series INSTRUCTION MANUAL

Please note the following additions/amendments to the instruction manual for FC-*i* series counting scale (WM:PD4000541).

(Page 14)

### Place Sample, Set Sample Size and ENTER

 If the calculated unit weight is too light, “Lo wt” (low unit weight) will be displayed, and you will be returned to Step 3.



 If the “Add Sample” display appears again, then the sample size is not large enough for accurate counting – add the additional number of sample pieces.

(Page 27)

### Changing Comparator Limits Temporarily

3. Change the Lower limit using 10-key pad and press the **ENTER** key. Then the display will return to the step 1 above with new limits.



3. Change the lower limit using 10-key pad and press the **ENTER** key. Then the display will return to normal with new limits.

(Page 28)

### Using the **\*** Key to Set the Time and Date

4. Use the 10-key pad to set the time and press the **ENTER** key to return to the step 1 and the clock will start from “00” second.

5. Press the **\*** key. The display will return to normal.



4. Use the 10-key pad to set the time and press the **ENTER** key to return to normal. The clock will start from “00” second.  
(“5.Press the **\*** key ....”: removed.)

(Page 29)

### 8-1. Calibration Procedure Using a Weight

 If you .....  
(For example: Using 10kg calibration weight that actually weighs 10.02kg.)



 If you .....  
(For example: Using 10kg calibration weight that actually weighs 10.002kg.)

F-00-02

<input type="checkbox"/> <b>Unit Weight (when "lb" is selected).</b>	
0	lb as piece weight.
1	lb as 1,000 piece weight.

F-01-04

<input type="checkbox"/> <b>Display ON Unit Weight – Reset or Last.</b>	
When the display is turned on, the scale can be set to recall the last unit weight used.	
0	Unit weight is RESET (cleared) when display comes on.
1	Unit weight last used (before display is turned off, not power interrupt) will be entered automatically.

F-04-02

<input type="checkbox"/> <b>Response</b>	
0	Fast / sensitive
1	Normal
2	Slow / stable

F-04-04

<input type="checkbox"/> <b>Beeper for key operation</b>	
0	Beeper ON.
1	Beeper OFF.

F-06-07-08-01

<input type="checkbox"/> <b>Data Out Mode / Bar Code Reader</b>	
0	Key mode: Data is sent by pressing the <b>PRINT</b> key. + command mode.
1	Stream mode: Data is sent continuously. command mode cannot be used.
2	Auto-print mode A: Data is sent if the weight display is stable at +5d (weighing display division) and above. + command mode.
3	Auto-print mode B: Data is sent if the weight display is stable at ±5d (weighing display division) and above/below. + command mode
4	Command mode only.
5	To use as Bar Code Reader Interface.

F-<sup>06</sup>07-<sup>08</sup>01

6	UFC format with Key Mode (see setting “0”).
7	UFC format with Auto-Print Mode A (see setting “2”).
8	UFC format with Auto-Print Mode B (see setting “3”).

(Page 47)

### Acknowledgment and Error Codes

- If the command is **[S]**, **[T]** or **[Z]**, the scale will send a second acknowledgment <AK> (06H) when the command operation is completed.



- If the command is **[I]**, **[S]**, **[T]** or **[Z]**, the scale will send a second acknowledgment <AK> (06H) when the command operation is completed.

(Page 47)

### Data Format

- ID Number and Item Code

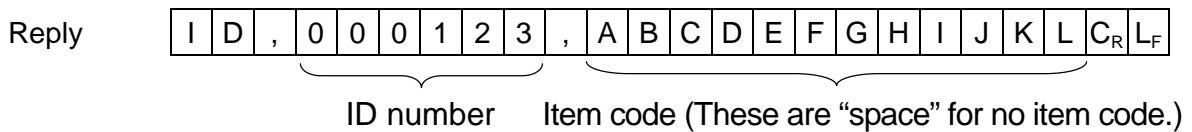
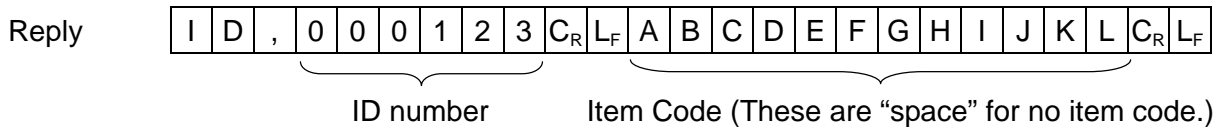

(Page 49)

- Memorize (enter) Total Count and Number of Addition into a specified ID memory.

ID Number:       Maximum 6 digits  
 Total Count:     Maximum 9 digits including sign  
 Lower Limit:     Maximum 8 digits



ID Number:       Maximum 6 digits  
 Total Count:     Maximum 9 digits including sign  
 Number of addition:   Maximum 8 digits

(The following sections are added to the section “11. RS-232C SERIAL INTERFACE”.)

### 11-6. Using a Bar Code Reader

- The bar code reader can be connected to the FC-*i*'s RS-232C interface. It can read bar codes for ID number, unit weight, tare weight and comparator limits.
- Any of the RS-232C interfaces can be used for the bar code reader.
- Set the F-Function F-06/07/08-01='5' to use a bar code reader. For example, to use Ch.1 (PORT 1), set F-07-01='5'.

## Requirement for the Bar Code Reader

Interface	RS-232C
Baud Rate	2400, 4800, 9600 bps
Character Code	ASCII
Terminator	C <sub>R</sub> or C <sub>R</sub> L <sub>F</sub>
Bar Code	EAN/JAN, UPC, Codabar (NW-7), Interleaved 2 of 5, Code39 etc., depending on the bar code reader.
Connector	D-Sub 9pin connector (recommended)

 In most cases, the bar code reader with RS-232C interface is to connect directly with a personal computer. It is necessary to convert signals to connect this kind of bar code reader with the FC-*i*. Refer to the diagram below.

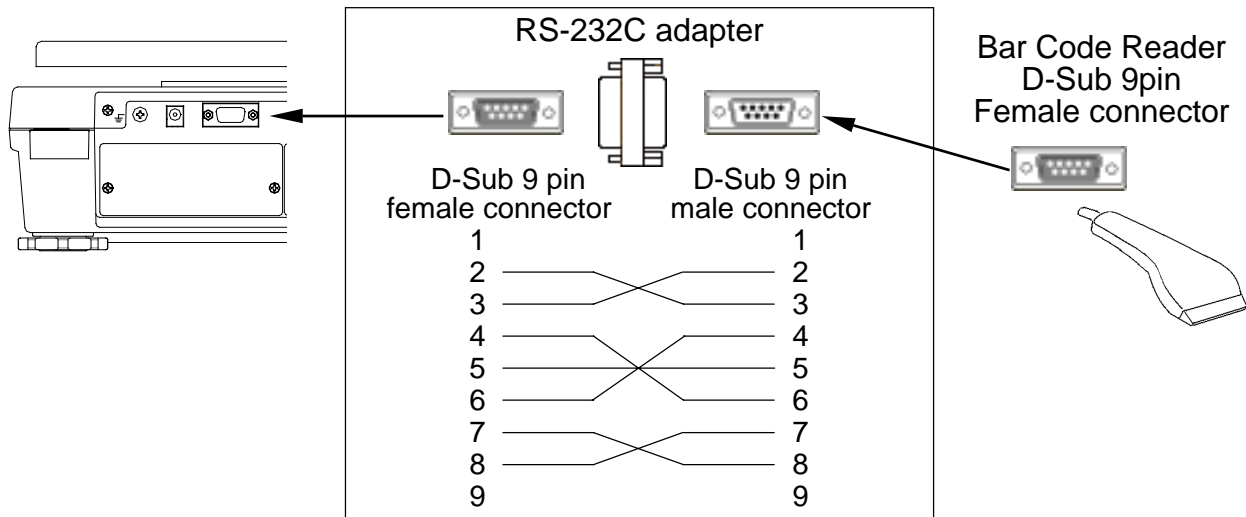

 Some bar codes will have start and stop characters. But set your bar code reader not to send those characters to FC-*i*. The FC-*i* doesn't accept such data.

 EAN/JAN/UPC bar codes usually have a check digit and other bar codes may have either. But set your bar code reader not to send the check digit. The FC-*i* doesn't accept such data. If accepted, the FC-*i* cannot know the difference between data and check digit.

Read the instruction/technical manual of your bar code reader to connect it with the FC-*i*.

## Bar Code Data and Format

The bar code data that the FC-*i* accepts are ID number, unit weight, tare weight and comparator limits.

The bar code has "2 digit identification code + 6 digits numbers" for ID number and "2 digit identification code + maximum 10 digits numbers including sign and decimal point" for the other data.

The unit weight and tare weight must be within 6 digits except nonsignificant zeros.

Unit weight 123.456 g:	"12+123.456"	acceptable
	"12+00123.456"	acceptable
	"12+0123.4560"	not acceptable
Tare weight 10 kg:	"15+10"	acceptable
	"15+0000010.0"	acceptable
	"15+010.00000"	not acceptable

❑ The comparator limits must be within 7 digits except nonsignificant zeros.

Upper limit:	“17+123”	acceptable
	“17+000000123”	acceptable
	“17+012345670”	not acceptable

Bar Code Data	Identification Code	Numbers	Function
ID Number	01	6 digits ID number.	Recall the unit weight by ID numbers. Similar function to “2-5. Unit Weight By ID Number”.
Unit Weight (g)	12	10 digits including sign and decimal point.	Enter a unit weight in “g” directly. Similar to “2-4. Unit Weight by KEYBOARD”
Unit Weight (lb)	13	10 digits including sign and decimal point.	Enter a unit weight in “lb” directly. Similar to “2-4. Unit Weight by KEYBOARD”
Unit Weight (lb/1000pcs)	14	10 digits including sign and decimal point.	Enter a unit weight in “lb/1000pcs” directly. Similar to “2-4. Unit Weight by KEYBOARD”.
Tare Weight (kg)	15	10 digits including sign and decimal point.	Enter a tare weight in “kg” directly. Similar to “3-1. Using the KEYBOARD TARE key”.
Tare Weight (lb)	16	10 digits including sign and decimal point.	Enter a tare weight in “lb” directly. Similar to “3-1. Using the KEYBOARD TARE key”.
Comparator Upper limit	17	10 digits including sign.	Change comparator upper limit temporarily.
Comparator Lower limit	18	10 digits including sign.	Change comparator lower limit temporarily.

❑ If the EAN/JAN/UPC-A is used for ID number, place “0” to the high-order digits to keep the necessary digit number.

Example of ID number “000123”

EAN/JAN-13	01000000123[3]	([3] shows check digit)
EAN-8	0100123[5]	([5] shows check digit)
UPC-A	0100000123[5]	([5] shows check digit)

⚠ When the data from bar code reader is not acceptable, the FC-i will beep 4 times.

- ♫ The data contains too many digits or too many significant digits.
- ♫ The data contains invalid identification code.
- ♫ The data is out of range. (The tare data is more than the capacity, etc.)
- ♫ The tare / unite weight has a minus sign.
- ♫ The data has start/stop characters or check digit. These will lead to the invalid identification code, too many digits and so on.









⚠ The check digit may be accepted as an effective number.

Example: EAN-8 / 0100123[5] ([5] is a check digit) can be accepted as ID number “001235”.

Do not set the bar code reader to send the check digit.



## Examples of Bar Code

ID No. = 123456	 01123456	Interleaved 2 of 5
ID No. = 123456	 0100001234562	EAN/JAN-13
ID No. = 123	 01001235	EAN/JAN-8
ID No. = 123	 010000001235	UPC-A
Unit Weight = 123.456g	 *12+123.456*	Code 39
Unit Weight = 0.27217 lb	 *13+000.27217*	Code 39
Tare Weight = 1.234 kg	 *15+00001.234*	Code 39
Tare Weight = 0.5 lb	 *16+0.5*	Code 39
Comparator Upper limit =12345	 A17+000012345A	Codabar (NW-7)

## 11-7. Using UFC (Universal Flex Coms) Function

- The UFC function allows you to print out as you format the printer (UFC format).
- The FC-*i* can store the UFC format as text data. It will include parameters to replace with count data, weight data and so on.
- The maximum number of text data is **384** characters.
- Using "PF" command, the text data have to be sent to the scale in advance. When the PRINT key is pressed or by auto-print mode A/B, the scale will send the stored text data with the parameters replaced by original data.
- Terminator for the "PF" command is "C<sub>R</sub>" or "C<sub>R</sub>L<sub>F</sub>".
- Set F-06/07/08-01="6", "7" or "8" to send the UFC format data.

## Store Text Data into the Scale Memory

Command	P	F	,	\$	P	C	,	'	T	E	X	T	'	,	#	2	0	,	\$	S	P	*	2	,	&
	\$	C	R	,	\$	L	F	,	\$	W	T	,	\$	C	R	,	\$	L	F	C <sub>R</sub>	L <sub>F</sub>				
Reply	<span style="border: 1px solid black; padding: 2px;">AK</span> <span style="float: right; margin-left: 20px;">Terminator</span>																								

The “PF” command sends text data that will include:

Parameters for the scale data and control codes

Parameter	Data & Code
\$PC	Count
\$WT	Weight
\$UW	Unit weight in use
\$TR	Tare weight in use
\$TL	Total count
\$AN	Accumulation numbers
\$CD	ID number in use
\$NM	Item code in use

Parameter	Data & Code
\$CP	Comparator result
\$DT	Date
\$TM	Time
\$CM	Comma
\$SP	Space
\$CR	Carriage Return
\$LF	Line Feed

ASCII text string

Text string is described in single quote marks as ‘Data’.

The single quote itself is written as ”(2 single quotes).

Example: Text ‘ABC’ is described as ”ABC”.

ASCII hexadecimal code

The ASCII hexadecimal codes are written in the form “# + 2 hexadecimal digits.

This will be mainly used to send control codes that can’t be described as text string.

Example: #04 “EOT”

Repeat data

The control codes \$SP, \$CR and \$LF can be used with “\* + maximum 2 digit number”. That code will be repeated number of times designated.

Example: \$LF\*9 Repeat “\$LF” 9 times.

\$SP\*12 Place 12 “Spaces”.

Link mark “&”

If you will send more than 2 lines data, attach “&” to the end of the line. Then, the scale considers the data to be continued.

 “Space” or “,” will be used to separate these data. You can skip them, but you cannot skip “,” after “PF”. You must start with “PF,”.

Data Format for the Scale Data

“ ” in examples below shows “Space” (20H).

Parameters for the scale data will be replaced by the format below when the scale sends them out.

 Data has the fixed number of digits including a sign and a decimal point. The insignificant zeros are replaced by “Space (20H)” (except the ID number).

\$PC	_ _ _ _ + 1 2 3 4 _ P C	1234 pcs / 9 digit data + 3 digit unit
\$WT	_ _ + 4 . 3 2 1 0 _ k g	4.3210 kg / 9 digit data + 3 digit unit
\$UW	+ 1 . 2 3 4 5 6 7 _ _ g	1.234567 g / 9 digit data + 3 digit unit
\$TR	_ _ + 1 . 2 3 4 5 _ k g	1.2345 kg / 9 digit data + 3 digit unit
\$TL	_ _ + 9 9 9 9 9 9 _ P C	999999 pcs / 9 digit data + 3 digit unit
\$AN	_ _ _ _ 1 2 3 4	1234 times / 8 digit data

\$CD 

0	0	0	1	2	3
---	---	---	---	---	---

 ID No. 000123 / 6 digit data  
 \$NM 

Z		D		5	.	6	V				
---	--	---	--	---	---	---	---	--	--	--	--

 12 characters  
 \$CP 

O	K

 Result is "OK" / 2 characters  
           Result is not available.  
 \$DT 

0	3	/	1	8	/	2	0	0	3
---	---	---	---	---	---	---	---	---	---

 The order of date obeys F-11-01.  
 \$TM 

1	2	:	3	4	:	5	6
---	---	---	---	---	---	---	---

 12(h) 34(m) 56(s)

### Examples of PF command and AD-8121 Printout Sample

AD-8121 Printout  
(F-06/07/08-03="0" or "1")

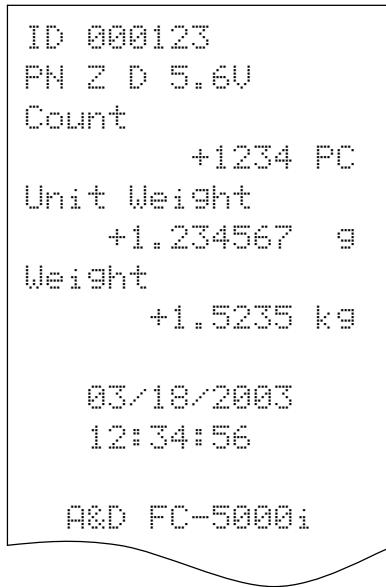

"PF" Command

PF,'ID ', \$CD,\$CR,\$LF,&  
 'PN ', \$NM,\$CR,\$LF,&  
 'Count', \$CR,\$LF,&  
 \$SP\*4,\$PC,\$CR,\$LF,&  
 'Unit Weight', \$CR,\$LF,&  
 \$SP\*4,\$UW,\$CR,\$LF,&  
 'Weight', \$CR,\$LF,&  
 \$SP\*4,\$WT,\$CR,\$LF,&  
 \$CR,\$LF,&  
 \$SP\*3,\$DT,\$CR,\$LF,&  
 \$SP\*3,\$TM,\$CR,\$LF,&  
 \$CR,\$LF,&  
 ' A&D FC-5000i', \$CR,\$LF

Terminator codes

⚠ Normally the printer needs to receive the terminator and do not forget to add the terminator code(s) to the end of text data.

(Page 57)

### SPECIFICATIONS

Platform Size (mm)	315 x 270
Platform Size (inches)	12.4 x 10.6



Platform Size (mm)	300 x 280
Platform Size (inches)	11.8 x 11.0

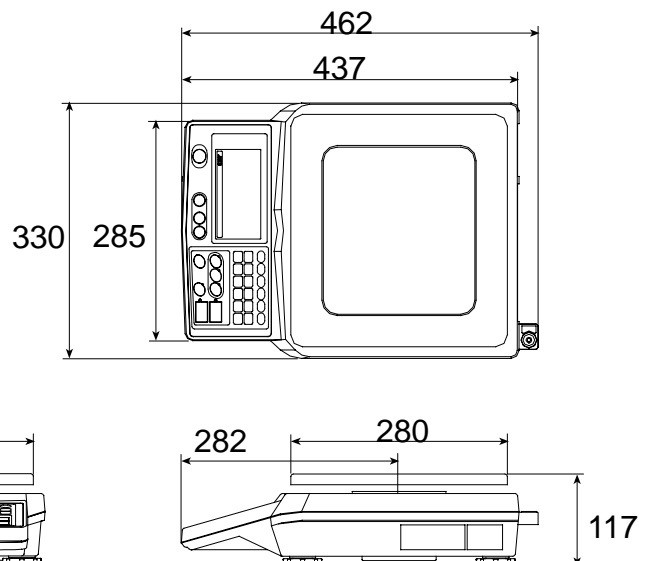

# 13. SPECIFICATIONS

MODEL	FC-5000 <i>i</i>	FC-10K <i>i</i>	FC-20K <i>i</i>	FC-50K <i>i</i>
Capacity (k)g	5000 g	10 kg	20 kg	50 kg
Resolution (k)g	0.5 g	1 g	2 g	5 g
Capacity lb	10 lb	20 lb	50 lb	100 lb
Resolution lb	0.0001 lb	0.002 lb	0.005 lb	0.01 lb
Sample Size	10 pieces normal – 5, 25, 50, 100 or random number, user selectable			
Min. Unit Weight (Normal mode)	0.1 g	0.2 g	0.4 g	1 g
Min. Unit Weight (Fine mode)	0.005 g	0.01 g	0.02 g	0.05 g
Non-linearity	±0.5 g	±1 g	±2 g	±5 g
Repeatability	0.5 g	1 g	2 g	5 g
Span Drift	0.002%/°C (5°C~35°C) typ.			
Operating Temp.	-10°C~40°C/14°F~104°F, less than 85% RH (No Condensation)			
Display	7 segment / 5x7 dot VFD			
Display Update	Approximately 10 times per second			
Interface	RS-232C (1ch.) standard, Maximum 3 ch. with optional interface			
Power	AC adapter or Optional Ni-MH Battery Pack Battery Operating Time: Approx. 10 hours (main scale only)			
Platform Size (mm)	315 x 270			
Platform Size (inches)	12.4 x 10.6			
Dimensions (D) x (W) x (H)	330 x 462 x 117 mm 13.0 x 18.2 x 4.6 inches			
Weight (approx.)	6.7 kg	6.7 kg	6.7 kg	7.5 kg
Calibration Weight	5kg±0.1g	10kg±0.2g	20kg±0.5g	50kg±1g
Accessories	This manual, AC adapter			

## Options

- OP-02 Ni-MH Battery Pack
- OP-03 RS-232C x 2ch. (See note)
- OP-04 RS-232C x 1ch. + Comparator Relay output (See note)
- OP-05 Remote Scale Interface
- Note OP-03 and OP-04 cannot co-exist.

## Dimensions

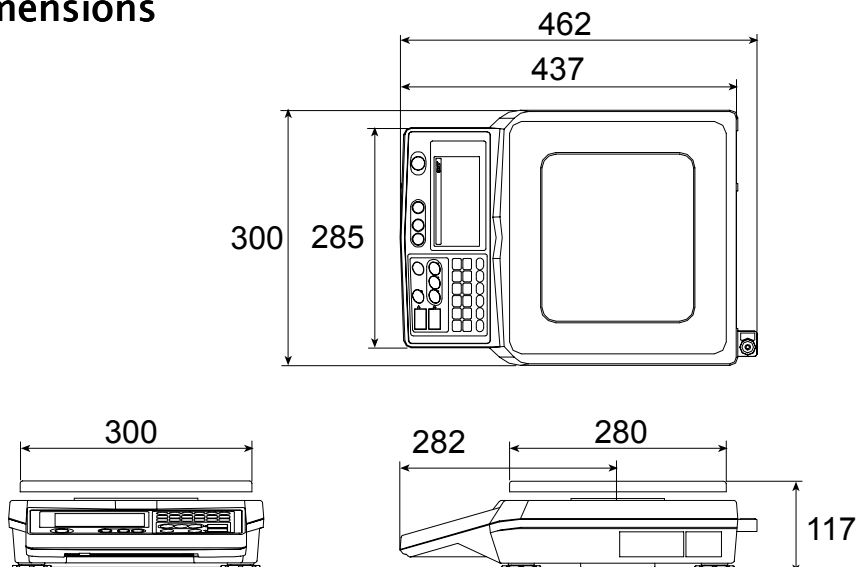

# 14. GRAVITY ACCELERATION MAP

Values of gravity at various locations

Amsterdam	9.813 m/s <sup>2</sup>	Manila	9.784 m/s <sup>2</sup>
Athens	9.807 m/s <sup>2</sup>	Melbourne	9.800 m/s <sup>2</sup>
Auckland, NZ	9.799 m/s <sup>2</sup>	Mexico City	9.779 m/s <sup>2</sup>
Bangkok	9.783 m/s <sup>2</sup>	Milan	9.806 m/s <sup>2</sup>
Birmingham	9.813 m/s <sup>2</sup>	New York	9.802 m/s <sup>2</sup>
Brussels	9.811 m/s <sup>2</sup>	Oslo	9.819 m/s <sup>2</sup>
Buenos Aires	9.797 m/s <sup>2</sup>	Ottawa	9.806 m/s <sup>2</sup>
Calcutta	9.788 m/s <sup>2</sup>	Paris	9.809 m/s <sup>2</sup>
Cape Town	9.796 m/s <sup>2</sup>	Rio de Janeiro	9.788 m/s <sup>2</sup>
Chicago	9.803 m/s <sup>2</sup>	Rome	9.803 m/s <sup>2</sup>
Copenhagen	9.815 m/s <sup>2</sup>	San Francisco	9.800 m/s <sup>2</sup>
Cyprus	9.797 m/s <sup>2</sup>	Singapore	9.781 m/s <sup>2</sup>
Djakarta	9.781 m/s <sup>2</sup>	Stockholm	9.818 m/s <sup>2</sup>
Frankfurt	9.810 m/s <sup>2</sup>	Sydney	9.797 m/s <sup>2</sup>
Glasgow	9.816 m/s <sup>2</sup>	Taichung	9.789 m/s <sup>2</sup>
Havana	9.788 m/s <sup>2</sup>	Taiwan	9.788 m/s <sup>2</sup>
Helsinki	9.819 m/s <sup>2</sup>	Taipei	9.790 m/s <sup>2</sup>
Kuwait	9.793 m/s <sup>2</sup>	Tokyo	9.798 m/s <sup>2</sup>
Lisbon	9.801 m/s <sup>2</sup>	Vancouver, BC	9.809 m/s <sup>2</sup>
London (Greenwich)	9.812 m/s <sup>2</sup>	Washington, DC	9.801 m/s <sup>2</sup>
Los Angeles	9.796 m/s <sup>2</sup>	Wellington, NZ	9.803 m/s <sup>2</sup>
Madrid	9.800 m/s <sup>2</sup>	Zurich	9.807 m/s <sup>2</sup>

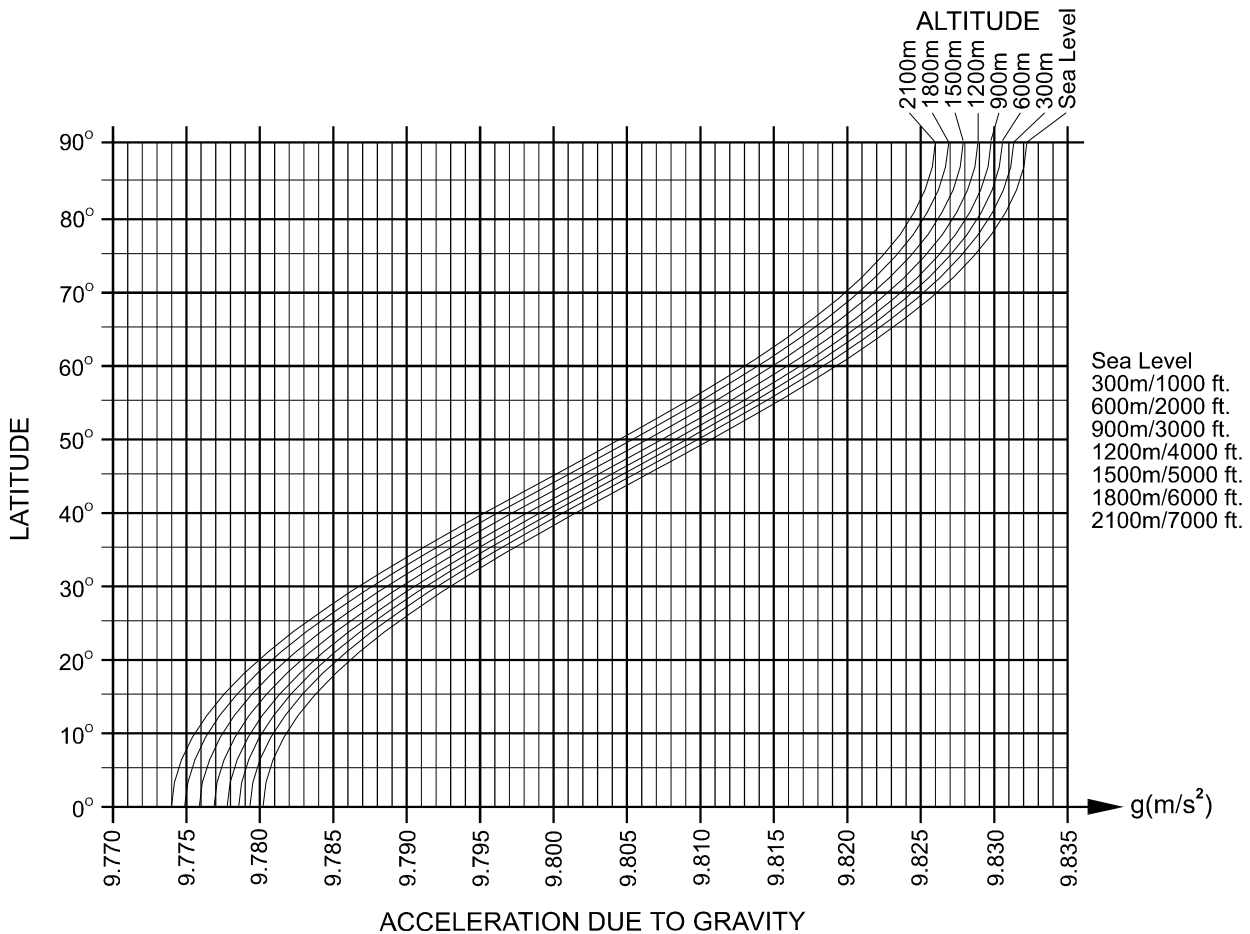

# World map

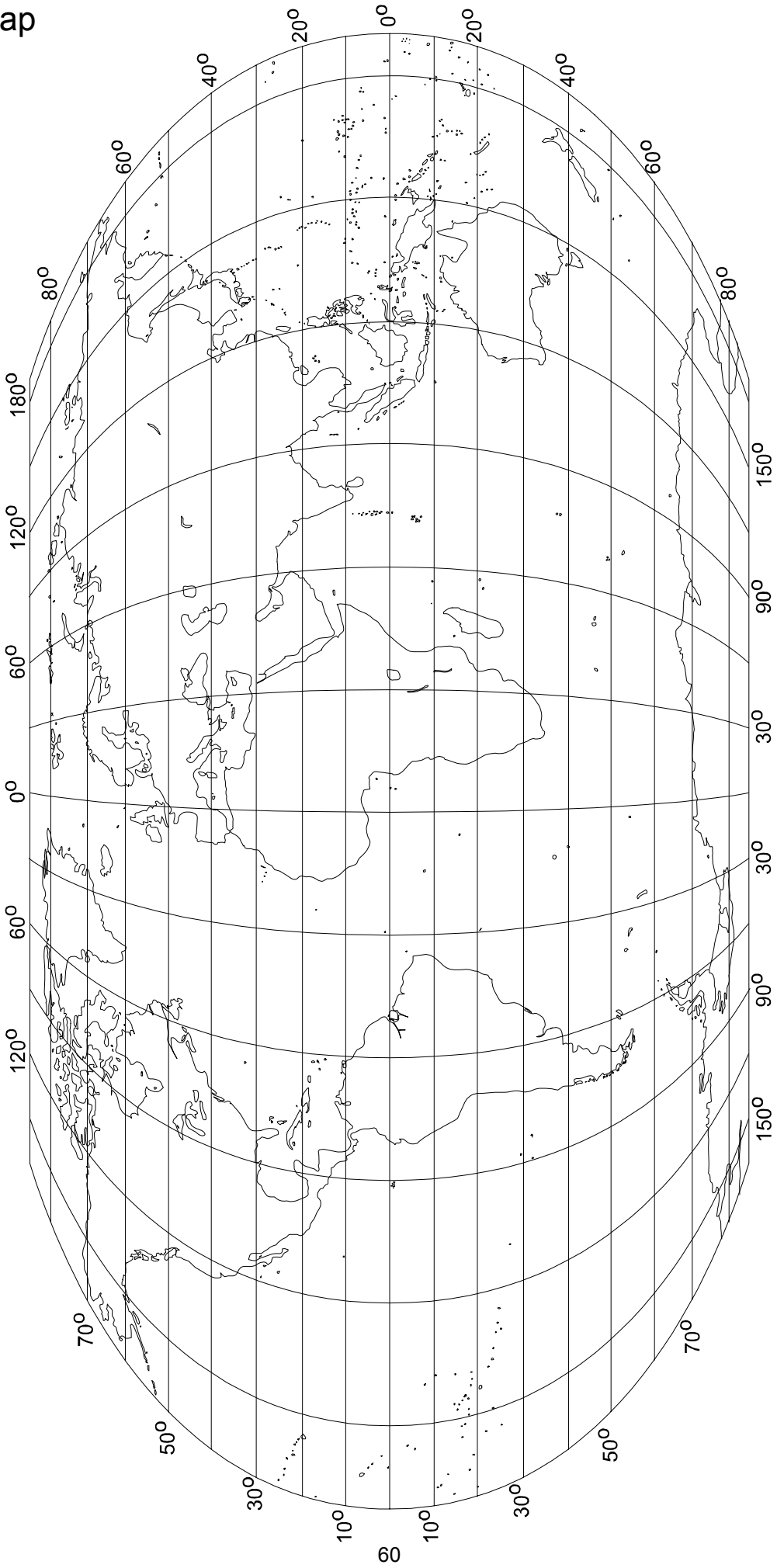





**A&D Company, Limited**

3-23-14 Higashi-Ikebukuro, Toshima-ku, Tokyo 170-0013 JAPAN  
Telephone: [81] (3) 5391-6132 Fax: [81] (3) 5391-6148

**A&D ENGINEERING, INC.**

1555, McCandless Drive, Milpitas, CA. 95035 U.S.A.  
Telephone: [1] (408) 263-5333 Fax: [1] (408)263-0119

**A&D INSTRUMENTS LTD.**

Unit 24/26 Blacklands Way, Abingdon Business Park, Abingdon, Oxon OX14 1DY United Kingdom  
Telephone: [44] (1235) 550420 Fax: [44] (1235) 550485

**<German Scales Office>**

Große Straße 13 b 22926 Ahrensburg GERMANY  
Telephone: [49] (0) 4102 459230 Fax:[49] (0) 4102 459231

**A&D MERCURY PTY. LTD.**

32 Dew Street, Thebarton, South Australia 5031 AUSTRALIA  
Telephone: [61] (8) 8352-3033 Fax: [61] (8) 8352-7409

**A&D KOREA Limited**

8th Floor, Manhattan Bldg. 36-2 Yoido-dong, Youngdeungpo-ku, Seoul, KOREA  
Telephone: [82] (2) 780-4101 Fax: [82] (2) 782-4280