

Operation Manual

Version 2.0

MR9610, SmartReader™ UV-Vis Microplate Reader



This instrument is for research use only

Foreword

Thank you for purchasing our MR9610, SmartReader™ UV-Vis Microplate Reader. This user manual describes how the instrument works and includes an operation guide, please read it carefully before operation and keep for future reference.

Initial check

Please check the instruments as well as all accessories with the packing list when first received and unpackaged. If you find any missing, please contact your distributor or Accuris Instruments.

Safety Warning and Guidelines

1. Important information for safe use

Users should have a clear understanding on use this instrument before operation. Please read this user manual carefully.



Please read the manual carefully and operate safely according to all guidelines.



This instrument is intended for Research Use Only

2. Safety Tips

The operation, maintenance and repair of the Instrument should comply with the basic guidelines and the warnings below.



Indoor use only.



Warning: Biological contamination hazard. All samples for testing, quality control, and calibration should be regarded as infectious, and any parts that come into contact with samples should also be treated as infectious. Please wear gloves and appropriate safety gear when operating this device.



Before using the device, read the operation manual carefully. These instruments are designed for use in a laboratory environment. The device must be operated by skilled laboratory personnel with the appropriate training.



Warning: Avoid injury. Keep your body or any part of body at a safe distance (1 foot or more) from the instrument when running.



The operator should not open or perform any repairs on the Instrument without specific instructions from Accuris Instruments or an authorized agent of Accuris. Performing any unauthorized service repairs will result in loss of warranty coverage. Contact Accuris Instruments or an authorized distributor or agent in the event of any service issues.



Before powering on, confirm that the voltage used meets the electrical requirements of the instrument as stated on the rating plate. If the electric cord is damaged, replace it with the same type. Hold the socket firmly when you pull the plug from an outlet, and don't pull the electric line only.



The Instrument should be installed in an environment of standard room temperature, low dust, low humidity and away from direct sunlight. Also make sure there is adequate ventilation, no corrosive gas or strong magnetic field.



Always power off the instrument when you are finished using it. Unplug the power cord and cover the instrument with a cloth or plastic sheet to prevent excessing dust from entering the housing.



Pull the connector plug from the electrical outlet immediately and contact the vendor in the case of:

- Liquid entering the housing.
- Abnormal operation: such as any abnormal sound or smell.
- The instrument is dropped or there is any damage to the housing.
- Any malfunction

Contents

Foreword.....	III
Initial check.....	III
Safety Warning and Guidelines.....	III
1. Important information for safe use.....	III
2. Safety Tips.....	IV
Chapter 1 Introduction.....	1
Chapter 2 Features.....	2
Chapter 3 Instrument Overview.....	4
Chapter 4 Installation.....	5
1. Initial check.....	5
2. Installation location and environment.....	5
3. Installation steps.....	5
Chapter 5 Operation Guide.....	7
1. Initial self-check.....	7
2. System settings.....	8
3. Protocol Management.....	9
4. Reading a Microplate.....	12
5. Result processing.....	18
6. Report exporting.....	26
7. Power off.....	27
Chapter 6 Maintenance, storage, transportation.....	28
1. Maintenance.....	28
2. Storage and transportation.....	28
Chapter 7 Trouble shooting.....	29
Chapter 8 Accessories.....	31

Chapter 1 Introduction

The SmartReader™ UV-Vis is an automated microplate reader for ELISA assays. Through absorbance readings, it can determine the concentration, as well as positive or negative detection of antibody and antigen in samples when used with ELISA kits and solutions. The instrument can also be used to test for purity and quantitate nucleic acids and proteins.

Key Features:

- 1) 10-inch color touch screen.
- 2) Operating system allows acquisition, editing and saving of data.
- 3) Stand-alone system incorporates built-in processing, it can be optionally connected to a PC with the use of SmartReader software.
- 4) Graphical interface displays a representative plate for easy setting of well parameters: blank, sample, standards, positive/negative, quality control and multi-value comparisons.
- 5) Dual optical channels, one used for sample detection, and one used for reference.
- 6) End-point method, kinetic readings, and spectral scanning can be performed.
- 7) Accepts plates with or without lids. Top heating prevents condensation.
- 8) Xenon lamp offers long life: 10^9 flashes (1,000,000,000), equivalent to approximately 1,300,000 plate reads.
- 9) Plate incubation feature allows accurate and uniform temperature control ($\leq 0.5^\circ\text{C}$ deviation between wells).
- 10) Top reading optical path with continual self-checking and automatic calibration option for monochromator wavelength and plate positioning.
- 11) Shaking function, time and speed are adjustable.
- 12) USB flash drive data export, for fast and easy data transfer.
- 13) Multi-user operation, data management for separate users.

Chapter 2 Features

Working conditions:

Ambient temperature: 10°C~40°C

Relative humidity: 30%~80% (Non-condensing environment)

Power: AC 100-240V 50-60Hz 2A

Parameters:

Parameter \ Model	MR9610
Light source	Xenon flash lamp >10 ⁹ flashes
Wavelength	200~1000nm
Bandwidth	< 2.5nm
Wavelength accuracy	±2nm
Wavelength repeatability	0.2nm
Read-out range	0.0-4.0 OD
Linearity@450nm	R ² ≥ 0.999, [0.0 – 3.0]
Accuracy@450nm	1.0% + 0.003 Abs (0 - 2.0] 2.0% (2.0 - 2.5 Abs]
Precision@450nm	CV < 0.5% or SD<0.003 (Precision mode); CV < 1.0% (Fast mode)
Stability@450nm	< 0.005A , (0.0 - 2.0] < 2% , (2.0 - 2.5]
Measurement speed	< 8 seconds in Fast mode (96-well plate) < 28 seconds in Precision mode (96-well plate) < 74 seconds in Precision mode (384-well plate)
Plate shaking	Linear (Slow : 16.8Hz, 1mm; Medium : 6.68Hz, 3mm; High : 2.44Hz, 15mm)
Incubation range	RT+ 5°C to 45°C
Temp. uniformity	± 0.5°C @ 37°C

Connections	1 B-type USB port for PC connection 1 Ethernet port 2 A-type of USB ports for mouse and printer connections
Power requirements	Included power adapter: DC24V 6.67A 160W, AC 100V – 240V
Dimension (W×D×H)	300×500×260mm / 11.8 x 19.7 x 10.25 inch
Weight (kg)	15.5kg / 34 Lbs

Chapter 3 Instrument Overview

Structure

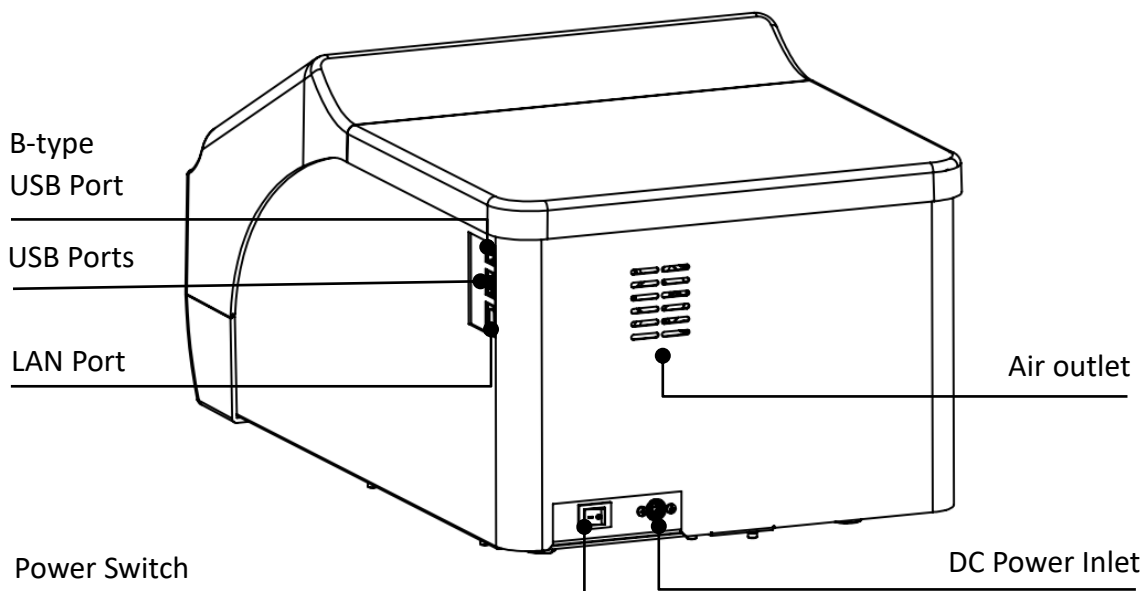
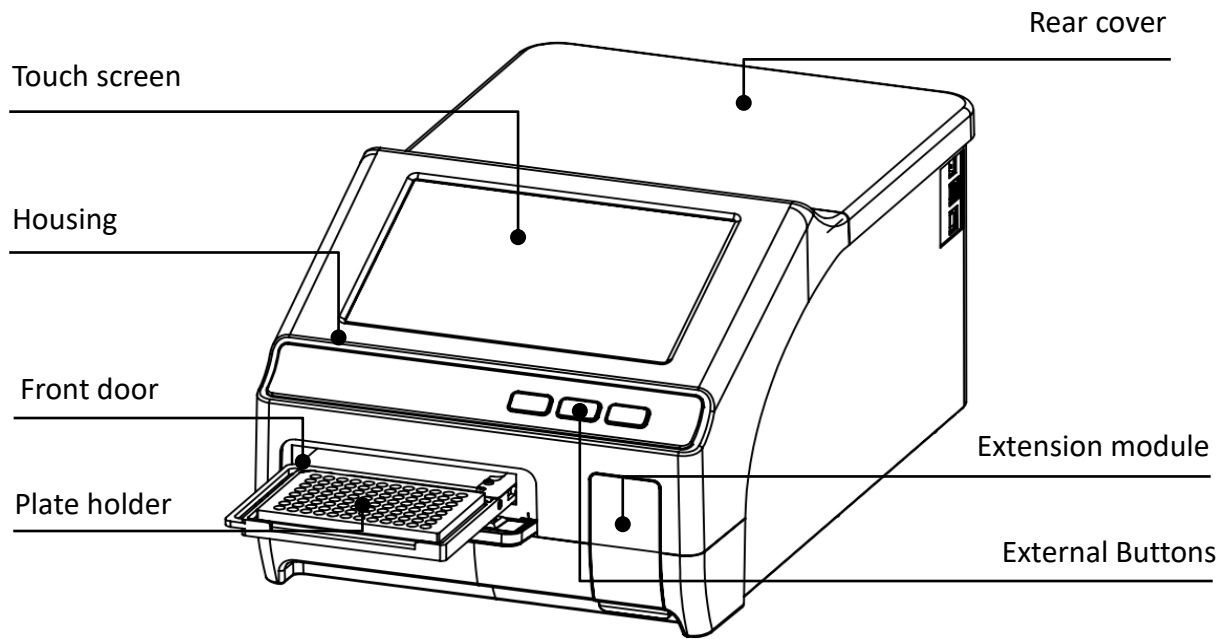

Chapter 4 Installation

1. Initial check

Each MR9610 is thoroughly tested before shipping, but please check it again when you receive the instrument and contact your local distributor or Accuris Instruments if:

- The outer package is damaged
- The outer package has any obvious moisture stains
- The outer package has marks of impact

After opening, please check the instrument and box contents.

Confirm that all ordered accessories have been included.

Check the instrument's appearance for any damage.

2. Installation location and environment

- Installation location: locate the instrument on a flat, dry, clean and stable surface, allow enough room on the front side so there is space for plate holder drawer to move in and out, and also keep 15cm / 6 inches of space behind and on the sides for any wires and air flow.
- Environment:
 - a. The environment for installation should not be excessively humid or dusty.
 - b. Temperature should be within the range of +10°C ~ +40°C.
 - c. Relative humidity should be within the range of 30% ~ 80% to avoid condensation.

Note: KEEP THE INSTRUMENT AWAY FROM CORROSIVE GASSES AND LIQUIDS.

3. Installation steps

- ① Place the instrument on a stable and level surface.

Note: DO NOT loosen any screws or parts without first consulting with the Accuris Instruments Service Department or your authorized distributor. Doing so can cause damage and void the warranty.

- ② Connect the instrument to an appropriate power outlet using the provided power cord.

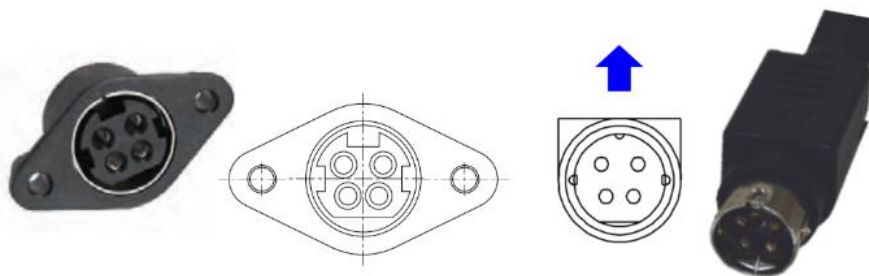

Fig. 1

Note: One cord coming from the power adapter will fit to the input jack on the back of the instrument. Make sure to connect it according to the above picture. The other cord will connect to a standard electrical outlet (100VAC to 230VAC)

- ③ After connecting the power cords, switch the power button on the rear of the instrument to the ON position, the front panel will cycle through a start-up and self-test screen.

Warning: Do not connect the instrument to a power outlet that is not properly grounded.

Chapter 5 Operation Guide

1. Initial self-check

This chapter explains a standard protocol set up and operation, beginning with the automatic self-check after power on. The following screen image will appear during the self-check:

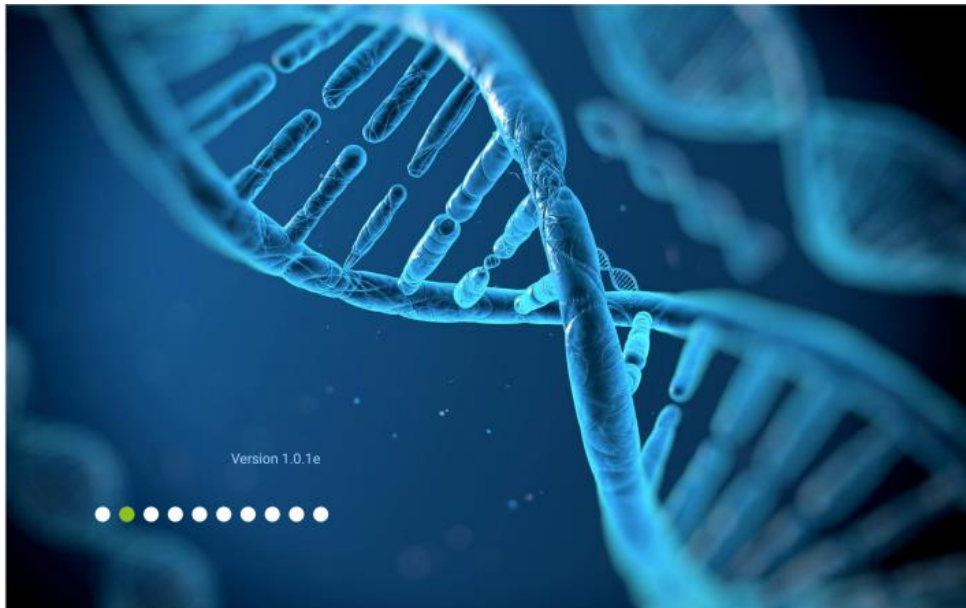

Fig 2

The user login interface will appear after the self-check, see Fig 3. This allows login as the Admin, existing user, or click "Guest".

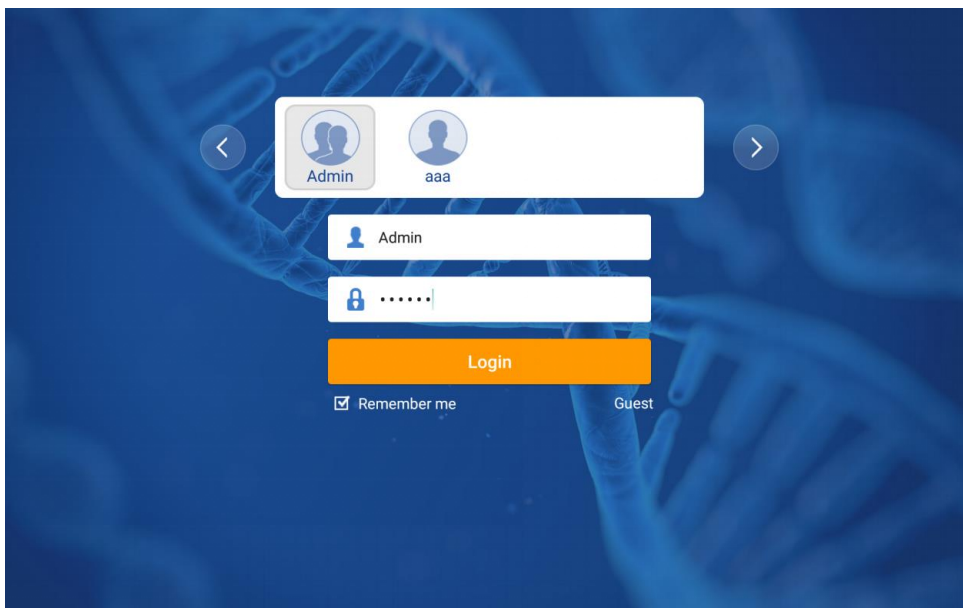

Fig 3

Table 1

User type	Creation Method	Default password	Permission	Export
Admin	Cannot be deleted	"123456"	For all files of Admin, User and Guest	All can be exported
User	Created by Admin	Default is "123456" or is set when creating	Access to files under the user account	
Guest	Cannot be deleted	No password		

Note: Please keep the Admin password recorded and in a safe place, and contact Accuris Instruments or your distributor if the Admin password is lost or forgotten.

After logging in, the Home Interface screen is displayed (Fig 4.)

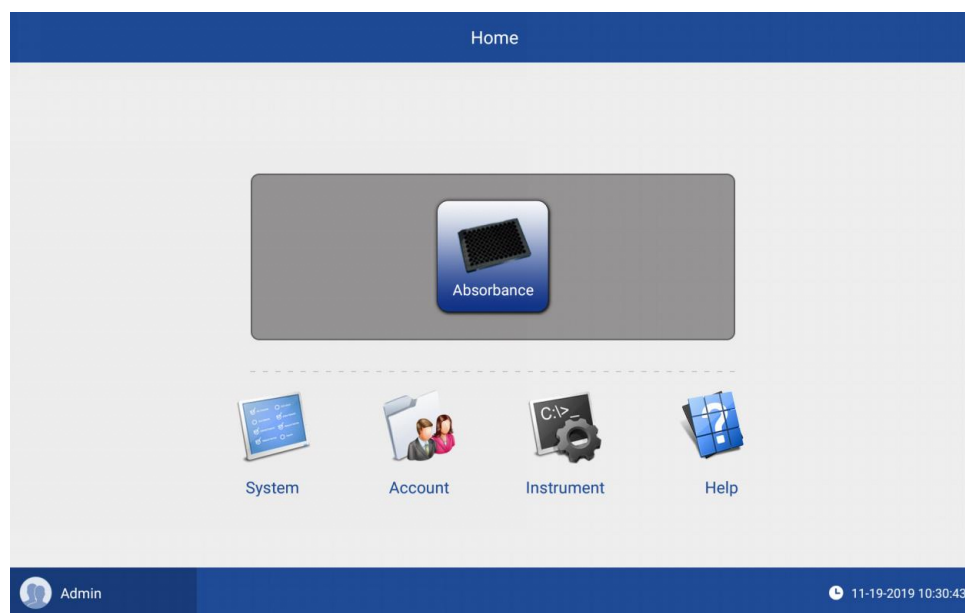

Fig 4

The "Admin" button on the lower left is for the logout and login interface.

2. System settings

In the "Systems" section, users create system settings (time, date and language) according to their needs, for details see Fig 5.

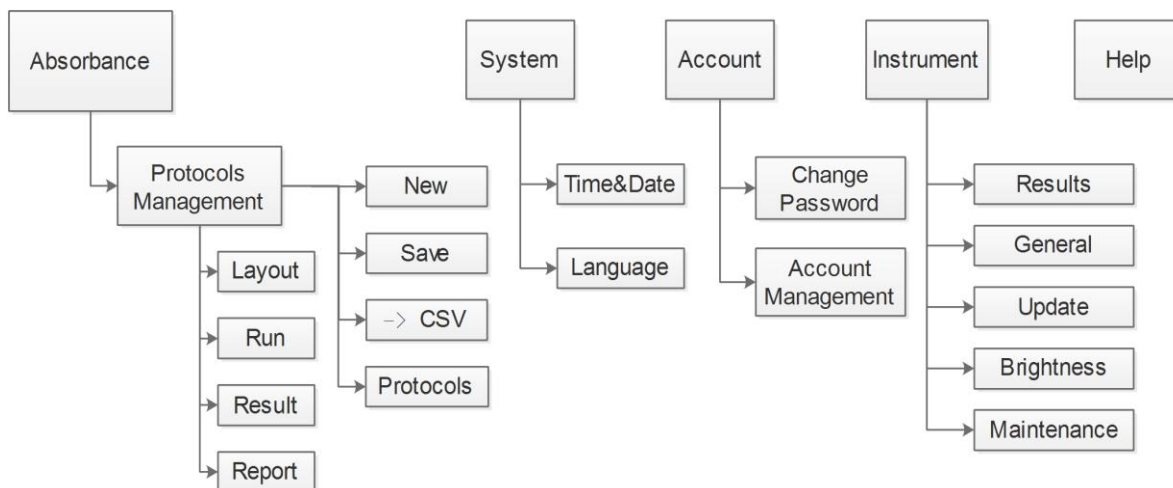

Fig 5

Note: 1. The instrument must be manually powered off and back on after the date and time settings are changed.

2. The Maintenance function is accessible only by authorized service representatives.

3. Click the “Home” button on the top left corner to go to the main interface.

3. Protocol Management

Click “Absorbance” on the home interface to enter the layout interface (fig 6). This interface is composed of six sections: the navigation bar at the top, the sidebar, the main display area, the optional bar, setting type selection and the status bar at the lower right area. The SmartReader UV-Vis incorporates a touch screen control panel, but the included mouse can also be used for all programming functions.

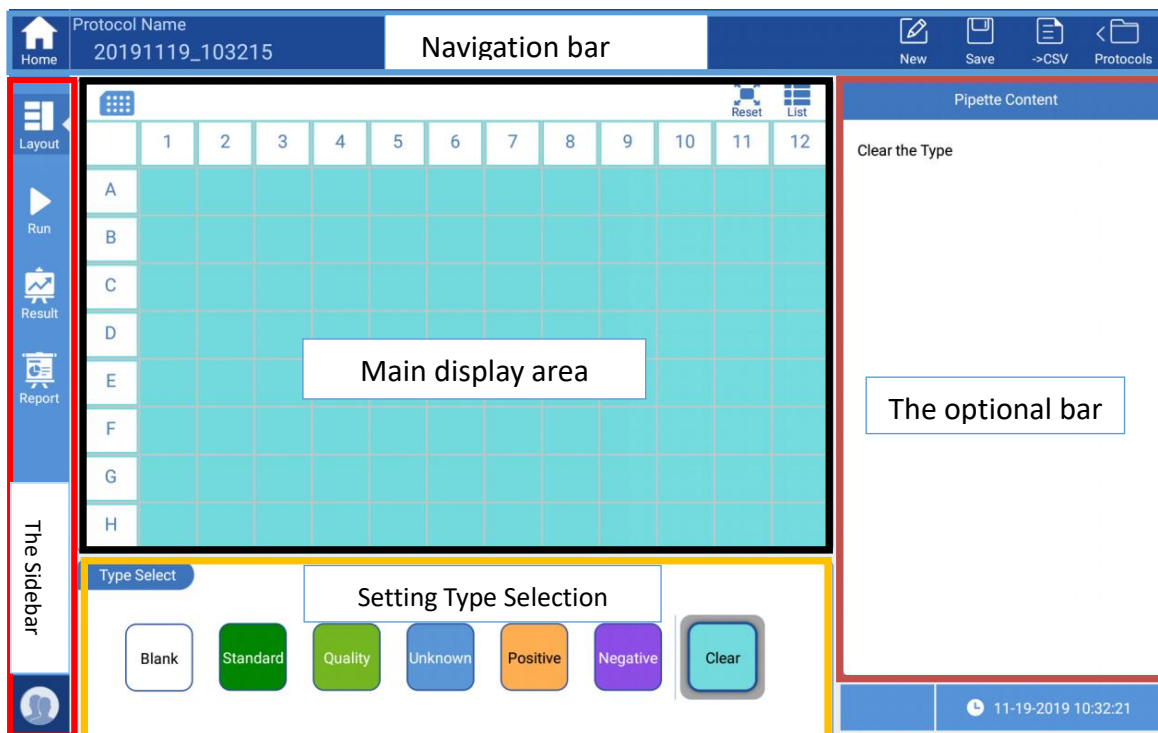
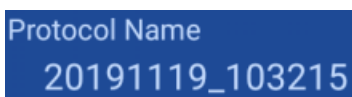

Fig 6



Protocol name can be modified by clicking it directly.



The default name of a new protocol is the system date and time, and it can be modified manually. A pop-up window will appear to remind the user when a modified protocol has not been saved.



Save the current protocol to the protocol list.



Shortcut for exporting raw data to a flash drive in .csv format. (Exports only the data displayed in the “Main Display Area”)



Open the Protocol folder for accessing saved protocols, sorting, deleting, importing, exporting, and renaming protocols. The Protocol list opens on the right side of the screen and can be closed by clicking on the left area.

Account	Admin	Edit
Search		
Name	Date	Type
1 demo1	2022/01/18 04:19:11	Locked
2 demo2	2009/09/01 00:00:28	Locked
3 demo3	2022/01/18 04:17:11	Locked
4 2022127new	2022/01/28 05:06:24	Data
5 20220119_044133	2022/01/19 23:17:20	Data
6 20220119_041650	2022/01/19 04:18:05	Data
7 20220119_003437	2022/01/19 00:34:53	Data
Total : 7 Files		
Import	Rename	Save as

Admin	Cancel
<input type="checkbox"/>	Name Date Type
	demo1 2022/01/18 04:19:11 Locked
	demo2 2009/09/01 00:00:28 Locked
	demo3 2022/01/18 04:17:11 Locked
<input type="checkbox"/>	2022127new 2022/01/28 05:06:24 Data
<input type="checkbox"/>	20220119_044133 2022/01/19 23:17:20 Data
<input type="checkbox"/>	20220119_041650 2022/01/19 04:18:05 Data
<input type="checkbox"/>	20220119_003437 2022/01/19 00:34:53 Data
Selected : 0 Files	
Delete	Export

Protocol list, standard state

Protocol list in "edit" state

Fig 7

When the protocol list is in the standard state, users can perform the below operations:

- Search: Enter a keyword to search the list.
- Sort: protocols can be sorted according to "Name", "Date" and "State". "demo1", "demo2" and "demo3" are always displayed at the first three positions.
- Import: For importing protocols from a flash drive to the instrument.
- Rename: Change the name of a protocol.
- Save as: Save as a new protocol.
- Edit: "Edit" button is located on the top right corner, see Fig 7 to enter the edit state.
- Account: Protocols of other accounts can be checked, but this function is only available for the Admin account.

When the protocol list in the edit state, the below operations are available:

- Sorting: protocols can be sorted according to "Name", "Date" and "State".
- Checkbox: "" can used to select more than one for batch operation.
- Delete: delete selected protocols.
- Export: For exporting selected protocols to a flash drive.
- Cancel: Return to the standard state of the protocol list.

4. Reading a Microplate

After a protocol name is created, the next step is to set the parameters according to the experiment requirements.

4.1 Plate layout settings

The interface will automatically display the plate in a 96 well plate layout when creating a new protocol. To change from a 96 to 384 well-layout, click on the top left of the plate layout to choose the required layout format.

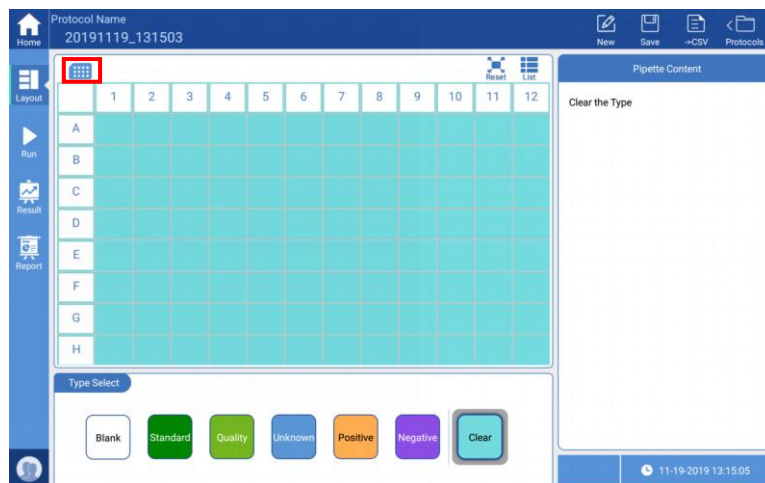

Fig 8

The plate layout menu allows choosing 6 well-setting options, as well as a clear option. Choose the appropriate setting type, and the option bar will change accordingly, then click the corresponding wells on the main display area to finish the settings.

Note: the entire plate (all wells) can be selected by clicking the blank box at the upper left corner of the plate layout.



Blank: Set for a blank control during measurement. The average absorbance value of the blank wells is subtracted from the absorbance values of the other wells after a plate read.

Standard: Used for creating the standard curve. After clicking “Standard”, the option bar will allow setting replicates and also calculations for quickly setting the standard concentrations, see Fig 9.



- Replicates: Use to set the same standard for multiple wells.
- Concentrations: After setting the concentration and unit of the first well, the protocol will calculate and set subsequent standards automatically according to the set operator and step size, or the values can be modified manually by clicking the corresponding wells.

Example: If the set concentration is 125ng/μL, the operator is “x” (multiply) and the step size is “2”, the concentration of the first well will be 125ng/μL, the second well 250ng/μL (2 x 125ng/μl) and the third 500ng/μL (2 x 250ng/μL)... etc.



Quality control. Settings are done in the same manner as the wells of standard samples.



Unknown samples. Users can set wells as unknown, and there in an additional “Factor” option if the unknown sample has been diluted. If a dilution has been used, set the value for the dilution factor “X. 1:X means the unknown sample was diluted X times.

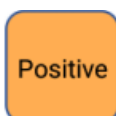

Positive Control, users can set several wells as positive controls

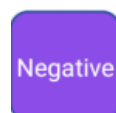

Negative Control, users can set several wells as negative controls



Used for clearing the settings of the plate layout.

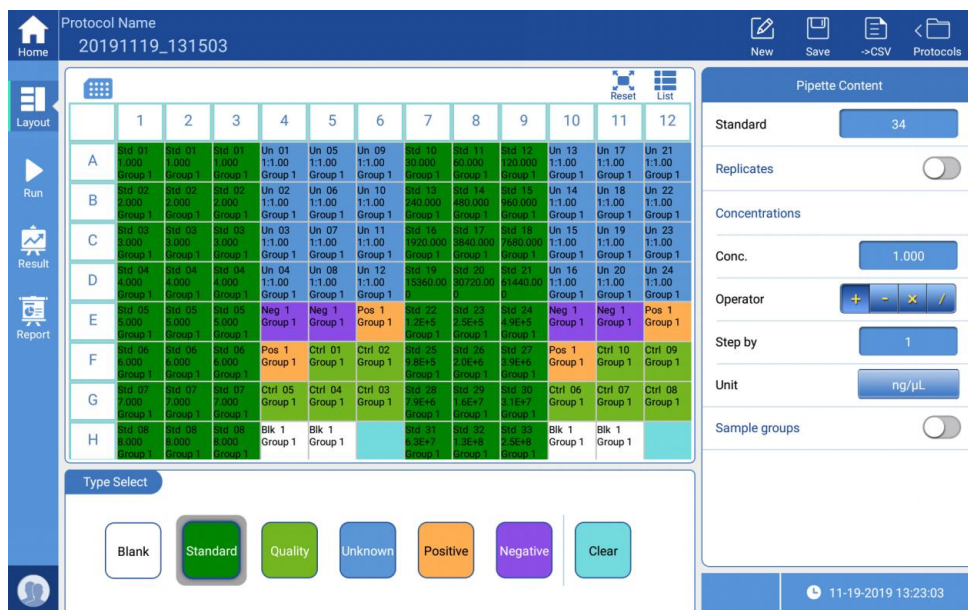

Fig 9

Note: The plate layout can be set up before or after the plate is read. For example, users can set all wells as “unknown”, read the absorbance values, then set up the layout of the plate. The absorbance value data and layout are separate, users can create or modify a layout to analyze absorbance data that was captured in the past.

Note: the absorbance values of a test cannot be changed!

4.2 Parameter setting

After completing the plate layout settings, click “Run” on the left side bar (see Fig 10.)

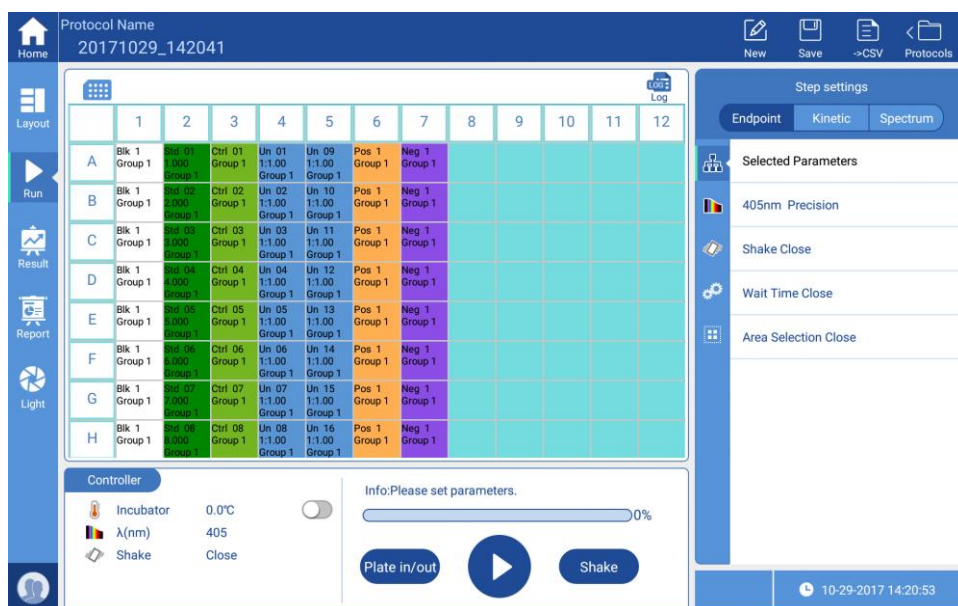

Fig 10

After clicking “Run” the lower window becomes a controller with the following functions:

- Incubator: The plate chamber can be set to a specified temperature, and the actual temperature is displayed.
- Wavelength: shows wavelength parameters of the current protocol.
- Shake: This function can be set to on or off.
- Progress bar: displays the running status of the current protocol.
- Plate in/out: control the motorized plate drawer to move it in and out; there is also a physical control button on the front of the instrument.
- Start/Stop: Used to start or stop a plate reading. There is also a physical button on the front of the enclosure for start/stop.
- Shake: This setting is independent from the shaking function in the settings menu, it is specifically used for plate defoaming.

In “Run” mode, the window on the right side allows choosing a specific measurement method: Endpoint, Kinetic or Spectrum, as well as reading parameters. See below table 2.

Table 2

Endpoint	Kinetic	Spectrum
<ul style="list-style-type: none"> └ Selected Parameters └ Wavelength <ul style="list-style-type: none"> └ Mode <ul style="list-style-type: none"> └ Fast └ Precision └ Wavelength <ul style="list-style-type: none"> └ λ1 (405) └ λ2 (450) └ λ3 (492) └ λ4 (630) └ Shake <ul style="list-style-type: none"> └ Speed <ul style="list-style-type: none"> └ Low └ Medium └ High └ Type <ul style="list-style-type: none"> └ Continuous └ Pulsed └ Time └ Wait Time at start └ Area Selection 	<ul style="list-style-type: none"> └ Selected Parameters └ Wavelength <ul style="list-style-type: none"> └ Mode <ul style="list-style-type: none"> └ Fast └ Precision └ Wavelength <ul style="list-style-type: none"> └ λ1 (405) └ λ2 (450) └ λ3 (492) └ λ4 (630) └ Kinetic <ul style="list-style-type: none"> └ Total Time <ul style="list-style-type: none"> └ Total Time └ Kinetic region └ No. of readings <ul style="list-style-type: none"> └ Number └ Kinetic region └ Shake <ul style="list-style-type: none"> └ Speed <ul style="list-style-type: none"> └ Low └ Medium └ High └ Type <ul style="list-style-type: none"> └ Continuous └ Pulsed └ Time └ Wait Time at start └ Area Selection 	<ul style="list-style-type: none"> └ Selected Parameters └ Wavelength <ul style="list-style-type: none"> └ Mode <ul style="list-style-type: none"> └ Fast └ Precision └ Wavelength <ul style="list-style-type: none"> └ Start Wavelength └ End Wavelength └ Step └ Shake <ul style="list-style-type: none"> └ Speed <ul style="list-style-type: none"> └ Low └ Medium └ High └ Type <ul style="list-style-type: none"> └ Continuous └ Pulsed └ Time └ Wait Time at start └ Area Selection

For wavelength selection, Endpoint and Kinetic are configured with four wavelengths (defaults are 405nm, 450nm, 492nm and 630nm), users can click on and modify these wavelength values manually, but must be within the range of 200nm~1000nm. Spectral analysis allows setting a wavelength range within 200nm~1000nm.

A “Log” button appears at the top right corner of the plate layout window after the current protocol has been executed.

The “Log” is mainly used for recording the finishing time of each step of a protocol.

Note: Steps cannot be edited if a protocol has been executed, users can save it as a new one and then edit.

4.3 Reading a Plate

Click “Plate in/out” on the screen or press “Plate in/out” on the front of the enclosure to open the plate drawer, load an ELISA plate on the plate holder, paying attention to the orientation of the plate so the A1 well is in the correct location. See Fig 11.



Fig 11

Click button “▶” on the display or press the “Start” button on the front of the instrument. If the protocol has already been run, a window will pop up to allow re-naming the protocol results file. Input a file name, click “ok” to run the protocol. The plate drawer will close, and during the reading process the screen will turn grey (see Fig 12) and all buttons will become inoperable with the exception of the stop button “◻”. The user can also press the “Stop” button on the front of the housing to stop a run.

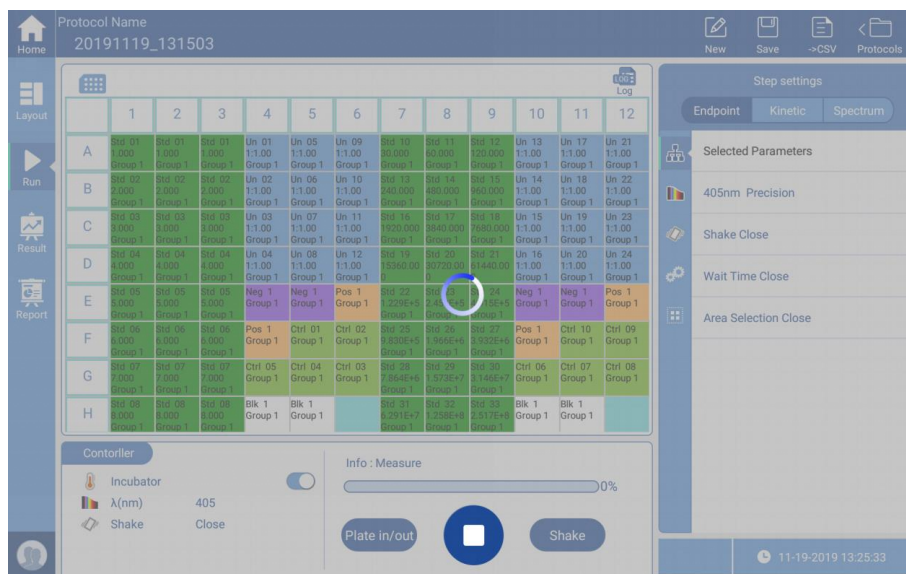

Fig 12

5. Result processing

The screen will stay in the “Run” interface after detecting samples and will display the original absorbance values measured. To view the analyzed results, switch to the “Result” interface by pressing the Result button on the side bar, see Fig 13.

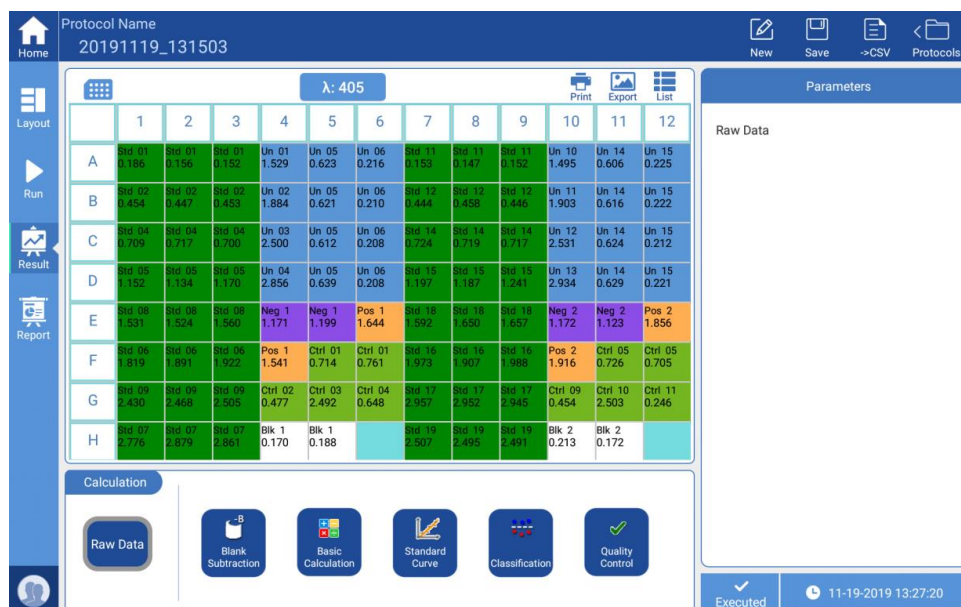

Fig 13

Results are displayed according to the protocol settings and measurement method. The above Fig 13 shows results of an endpoint reading. Here, according to different types of detection modes, the Result is divided into three modes: Endpoint, Kinetic and Spectrum.

5.1 Endpoint result

As Fig 13 shows, data processing options for an endpoint result include: “Raw Data”, “Blank Subtraction”, “Basic Calculation”, “Standard Curve”, “Classification” and “Quality Control”.

- Raw data: displays absorbance values of each well. If the plate was read using multiple wavelength, the user can switch to different wavelengths by pressing the button “ $\lambda: 562$ ” at the top, middle of the main interface. Blank Subtraction: An average blank absorbance value is obtained per the wells set for “blank” samples. This average value is then subtracted from the absorbance values for each sample well.

Note: 1. The Blank Subtraction button is only available if blanks have been set in the protocol layout interface.

2. When a protocol layout is set with blank samples, the absorbance values of “Basic Calculation”, “Standard curve”, “Classification”, “Quality Control” and “Kinetic Analysis” all include the subtraction of the blank value.

- “Basic Calculation”: the four basic functions of “+”, “-”, “x”, “/” can be performed on the absorbance values at different wavelengths of the same well.
- “Standard Curve”: Based on the concentrations set for the standard wells and the corresponding measured absorbance values, the instrument will generate a standard curve and use this for sample concentration calculations, see Fig 14.



Fig 14

If the curve fit is not closely matching the data points, the curve type can be changed in

the “Parameters” window on the right of the interface. Below are the 8 curve fitting types available:

- Linear fitting (Minimum Standards required: 2)
- Four Parameters Logistic (4PL) (Minimum Standards required: 4)
- Quadratic polynomial (Minimum Standards required: 3)
- Cubic polynomial (Minimum Standards required: 4)
- Quartic polynomial (Minimum Standards required: 5)
- Point-to-point (Minimum Standards required: 2)
- Cubic Spline (Minimum Standards required: 3)
- Logit/Log (Minimum Standards required: 2)

The absorbance values and concentration values of the standards are set to a curve. The SmartReader supports the following types of curve fittings that can be chosen to best fit the standard curve. When R^2 value is closest to 1.0, this indicates an optimized curve fit.:

- Linear/Linear (Linear fitting of absorbance value and corresponding concentration)
- Linear/Log (Linear fitting of absorbance value and the logarithm of the concentration)
- Log/Linear
- Log/Log

Note: In order to generate a curve, standard wells must be set up on the Protocol Layout Interface. Some curve types require a minimum quantity of standards. In the event of a “curve fit failure”, additional standards and concentration values may need to be included in the layout settings.

- Qualitative analysis: Samples can be qualitatively analyzed in relation to negative and positive references as set up in the plate layout. (see Fig 15). A formula is set up (on the right side of the interface), for calculating and marking positive “+”, weak positive “+”, or negative (no marking) sample wells automatically. Enter the appropriate values to create the formula for the “critical value”, “weak value”, and select if positive result will be > or < the critical value.



Fig 15

Note: The Protocol layout interface must be set with at least one positive or negative well, or the “Classification” button will not be available. See Fig. 15

- Quality Control: Click “Quality Control” button, (see Fig 16), the main display area will turn out to be a list, it displays status of the quality control wells which have set previously, the instrument will mark the samples according to conditions set in “Parameters “Parameters”.

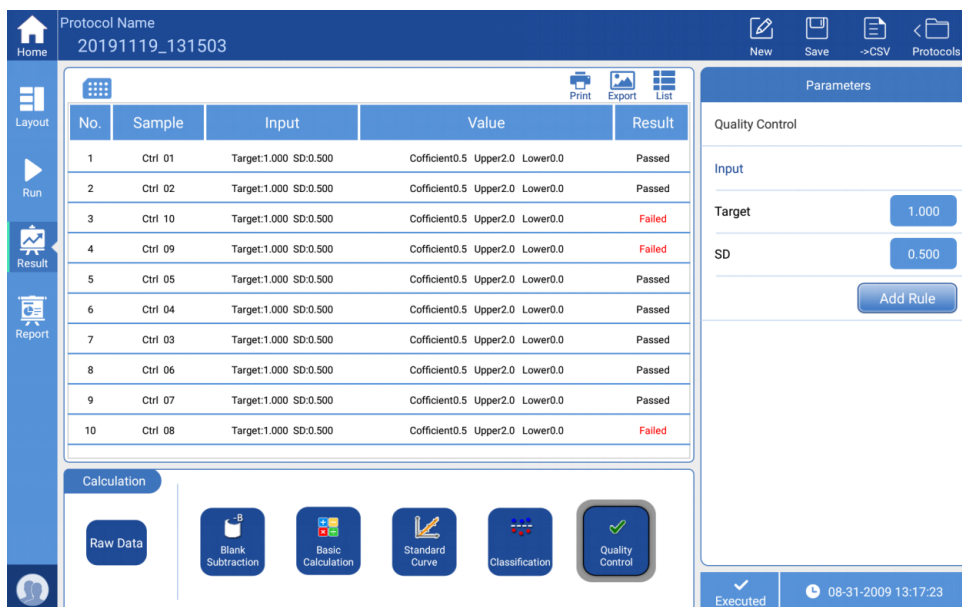

Fig 16

Note: protocol layout interface must be set with “Quality” wells, otherwise, this button will be not available.

5.2 Kinetics

After a kinetic type assay, the results screen will display small graphs inside the squares instead of absorbance values (see Fig 17).

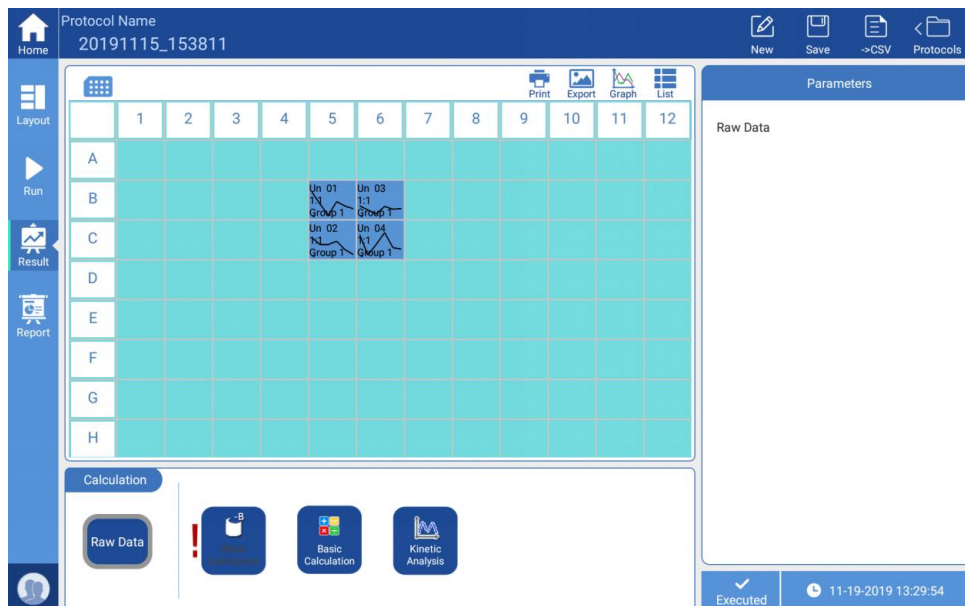

Fig 17

To see the detailed absorbance results for a specific well, select the target well, then click the “Graph” button at the top right to enlarge the kinetic curve (see Fig 18). Click “Back” to return to the main interface.



Fig 18

The “Calculation” window at the bottom offers four selections: “Raw Data”, “Blank Subtraction”, “Basic Calculation” and “Kinetic Analysis” (see Fig 18).

For functions and algorithms of “Raw Data”, “Blank Subtraction” and “Basic Calculation”,

please see Section 5.1.

Clicking the “Kinetic Analysis” button, the window on the right side will offer different calculation options, (see Fig 19).

The calculations available include:

- Average/SD/CV%
- Integral
- Baseline Subtraction
- Select Single Reading
- Select Reading Range
- Maximum Rate
- Maximum (Peak)

The screenshot displays the software interface for the MR9610 Microplate Reader. The top bar shows the protocol name "20191115_153811" and a wavelength of $\lambda: 405$. The main area is a 96-well plate grid with columns 1-12 and rows A-H. Data is entered in row B: column 5 has "Un 01 -2.405" and column 6 has "Un 03 -2.680". Row C has "Un 02 -2.177" in column 5 and "Un 04 -2.001" in column 6. The right sidebar is titled "Parameters" and shows "Kinetic" as the mode, "Average / SD / CV%" as the calculation type, and a reading range from "From 1" to "To 6". The bottom of the interface features a "Calculation" section with buttons for "Raw Data", "Baseline Subtraction", "Basic Calculation", and "Kinetic Analysis". The status bar at the bottom right indicates "Executed" at "11-19-2019 13:32:52".

Fig 19



Fig 20

5.3 Spectral Analysis

See Fig 20 (above), select the target wells. click “Graph” button to enlarge the spectral curve, the absorbance of each wavelength shown on the curve. Users can click the “Back” button to return to the main interface.

Click “Spectral Analysis”, see Fig 21, for further analysis.

Calculations available:

- Spectral Maximum: read the maximum value greater than the threshold value within a set range.
- Spectral Normalization: set the spectral range, take the maximum absorption peak as 1, the remaining values will be converted into percentage based on this criterion.
- Ratio within the Spectrum: set two wavelength values λ_1 and λ_2 , calculate the value of λ_1/λ_2 .
- Select Wavelength Range: read measurement values within a set wavelength range.

- **Select Single Wavelength** : read the measurement value of a single wavelength.

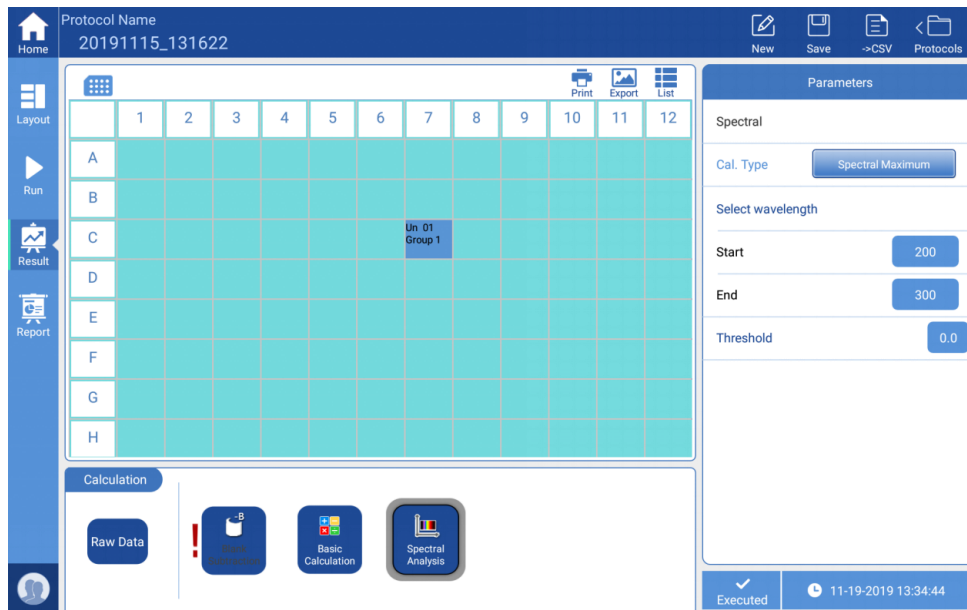

Fig 21a

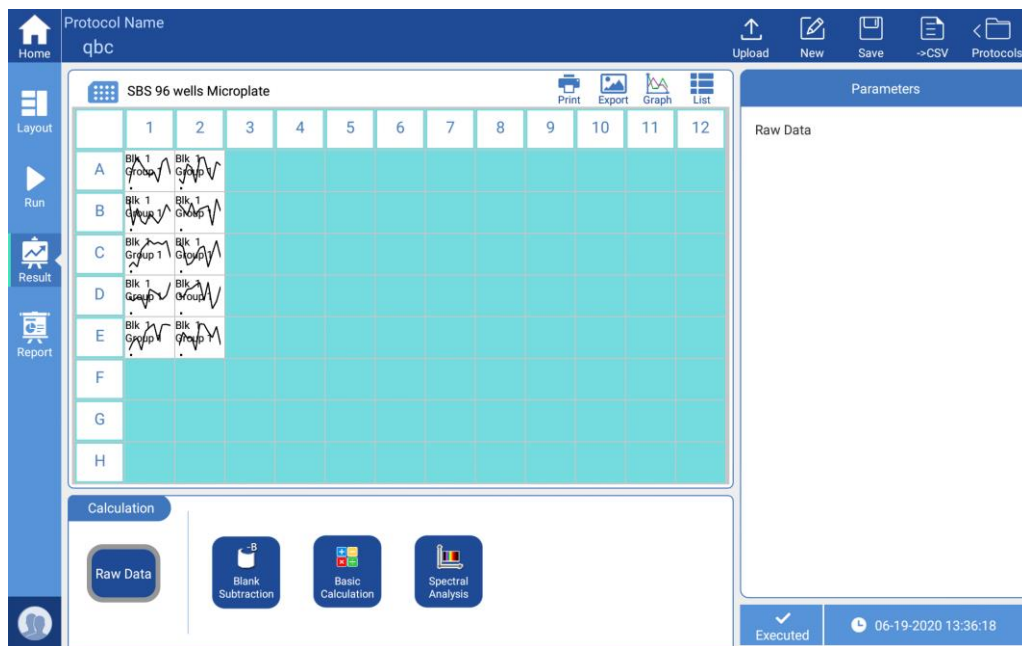

Fig 21b

Description of each button on the upper right corner of the main display area:



Print the current content of the main display area to a connected thermal printer



Export the current content of the main display area as an image file to a flash drive.



Choose a well to view the kinetic curve, the “Graph” button can enlarge the curve, see Fig 17, “Back” is to return to the main interface.



Switch from plate layout view to a data list display, click the “Plate” button in the upper right corner to switch back to the plate layout display.



Restore the zoom function



Return to the previous interface

6. Report exporting

Both processed data and raw data can be exported, click the “Report” button on the left side menu, see Fig 22.

The screenshot shows the software interface with a protocol name of 20191119_131503. The main area displays a 12x8 grid of data points for wells A-H. The 'Report' button is highlighted in the left sidebar. Below the data table, there is a 'File Type' section with icons for XLS, CSV, PDF, and TXT, along with a 'Print' button. On the right, an 'Output Content' panel lists various report sections like 'General information', 'Instrument information', and 'RawData', each with a checkmark. At the bottom right, there is an 'Output' button and a status bar showing 'Executed' and the time '11-19-2019 13:36:11'.

	1	2	3	4	5	6	7	8	9	10	11	12
A	Sid 01 0.186	Sid 01 0.156	Sid 01 0.152	Un 01 1.529	Un 05 0.623	Un 06 0.216	Sid 11 1.153	Sid 11 1.147	Sid 11 1.152	Un 10 1.495	Un 14 0.606	Un 15 0.225
B	Sid 02 0.454	Sid 02 0.447	Sid 02 0.453	Un 02 1.884	Un 05 0.621	Un 06 0.210	Sid 12 0.444	Sid 12 0.458	Sid 12 0.446	Un 11 1.903	Un 14 0.616	Un 15 0.222
C	Sid 03 0.709	Sid 03 0.717	Sid 03 0.700	Un 03 2.500	Un 05 0.612	Un 06 0.208	Sid 14 1.724	Sid 14 1.719	Sid 14 1.717	Un 12 2.531	Un 14 0.624	Un 15 0.212
D	Sid 05 1.152	Sid 05 1.134	Sid 05 1.170	Un 04 2.856	Un 05 0.639	Un 06 0.208	Sid 15 1.197	Sid 15 1.187	Sid 15 1.241	Un 13 2.934	Un 14 0.629	Un 15 0.221
E	Sid 06 1.531	Sid 06 1.524	Sid 06 1.560	Neg 1 1.171	Neg 1 1.199	Pos 1 1.644	Sid 16 1.592	Sid 16 1.650	Sid 16 1.657	Neg 2 1.172	Neg 2 1.123	Pos 2 1.856
F	Sid 06 1.819	Sid 06 1.891	Sid 06 1.922	Pos 1 1.541	Ctrl 01 0.714	Ctrl 01 0.761	Sid 16 1.973	Sid 16 1.907	Sid 16 1.988	Pos 2 1.916	Ctrl 05 0.726	Ctrl 05 0.705
G	Sid 06 2.430	Sid 06 2.468	Sid 06 2.505	Ctrl 02 0.477	Ctrl 03 2.492	Ctrl 04 0.648	Sid 17 2.957	Sid 17 2.952	Sid 17 2.945	Ctrl 09 0.454	Ctrl 10 2.503	Ctrl 11 0.246
H	Sid 07 2.776	Sid 07 2.879	Sid 07 2.861	Blk 1 0.170	Blk 1 0.188		Sid 19 2.507	Sid 19 2.495	Sid 19 2.491	Blk 2 0.213	Blk 2 0.172	

Fig 22

Choose the desired format in the “File Type” window at the bottom, four formats are available:

- XLS
- CSV
- PDF
- TXT

Choose the content to export in “Output Content” on the right side, “√” will appear next to the selected content, then click “Output” to export data to a flash-drive.

“Print”: The print function can only be used to print the instrument’s basic information, including instrument serial number, software version etc.

7. Power off

Press the “Plate in/out” button to remove the ELISA plate from the Reader, then press the button again to insert the empty plate holder back into the chamber.

Turn off the power switch on the back of the instrument.

Chapter 6 Maintenance, storage, transportation

1. Maintenance

- Keep the installation environment dry and clean to prevent moisture, corrosion, and strong electromagnetic interference sources.
- The SmartReader Instrument is calibrated before it leaves the factory. There are no user-serviceable parts inside, so please do not attempt to open the housing. If any defects or operation problems arise, please contact your distributor or Accuris Instruments at 908-769-5555 or info@accuris-usa.com.
- Do not switch on and off the power abruptly, as this can damage the electronics.
- Make sure to connect the SmartReader to an appropriate power outlet (voltage and Hz) as stated on the instrument rating plate.
- Maintenance list

Content	Daily	Weekly	Annually	When needed
Make sure the instrument powers off correctly				√
Keep the instrument away from dust	√			
Remove spilled solutions right away to prevent damage, then clean it with distilled water.	√			
If any surface has been contaminated with biohazardous materials , sterilize it using a disinfectant.	√			
Clean instrument housing regularly.		√		
Clean the plate holder when necessary.		√		
Maintenance				√

2. Storage and transportation

- When not in use, store the instrument at a temperature range $-10^{\circ}\text{C}\sim 40^{\circ}\text{C}$, relative humidity less than 80%, without corrosive gas and with good ventilation.
- Prevent from heavy vibrations and humidity during transportation.

Chapter 7 Troubleshooting

No	Trouble description	Possible reason	Solution
1	The Microplate Reader cannot be started	Power supply failure	a. Check that there is power to the instrument b. Make sure that all power cords are connected properly c. Confirm that the wall voltage is correct.
2	“Communication timeout” during self-checking	Instrument not working	Restart the instrument and try again; if the problem persists, please contact your distributor or Accuris Instruments.
3	“E913, E923, E933, E943” during self-checking	Insufficient light intensity	Please contact your distributor or Accuris Instruments.
4	“E912, E922, E932, E942” when self-checking	Light intensity is too strong	Please contact your distributor or Accuris Instruments.
5	“E911, E921, E931, E941” when self-checking	Excessive dark current	Please contact your distributor or Accuris Instruments.
6	“E612, E622, E632, E642” when self-checking	Detection module failure	Please contact your distributor or Accuris Instruments.
7	“E401, E403, E415, E425, E435, E445” when self-checking	Motor failure	Please contact your distributor or Accuris Instruments.
8	“E011~E056” when self-checking	Incubation failure	Please contact your distributor or Accuris Instruments.
9	Test results are greatly deviated or all are zero	Xenon lamp damaged	Restart the instrument and try again; if the problem persists, please contact your distributor or Accuris Instruments.
10	Elisa plate holder not properly moving in or out	Something is obstructing the movement	Check for any objects around the plate holder, if the plate cover is raised, or if the plate is not inserted properly
11	Abnormal noise occurs during running	The Elisa plate is not correctly seated or the plate cover is not seated	a. Check Elisa plate b. If the noise still occurs there when running without a plate, restart the instrument c. If noise persists, please contact your distributor or Accuris Instruments.

12	Test results are unstable	Light path failure	Check that the plate is properly seated, if liquid has spilled out and whether the front door is working correctly, then re-start the instrument. If problem still occurs, contact your distributor or Accuris Instruments
13	Instrument stops running during detection	Communication breakpoint	Press “stop”, restart the detection

Chapter 8 Accessories

No.	Item	Type	Unit	Qty	Remarks
1	Power cord		PCS	1	
2	AC/DC Power Adapter	24V 160W	PCS	1	
3	Mouse	Logitech	PCS	1	
4	Performance test statement		PCS	1	
5	Operation Manual		PCS	1	
6	Packing List		PCS	1	
7	Flash Drive		PCS	1	
8	Certification		PCS	1	
9					

Memo

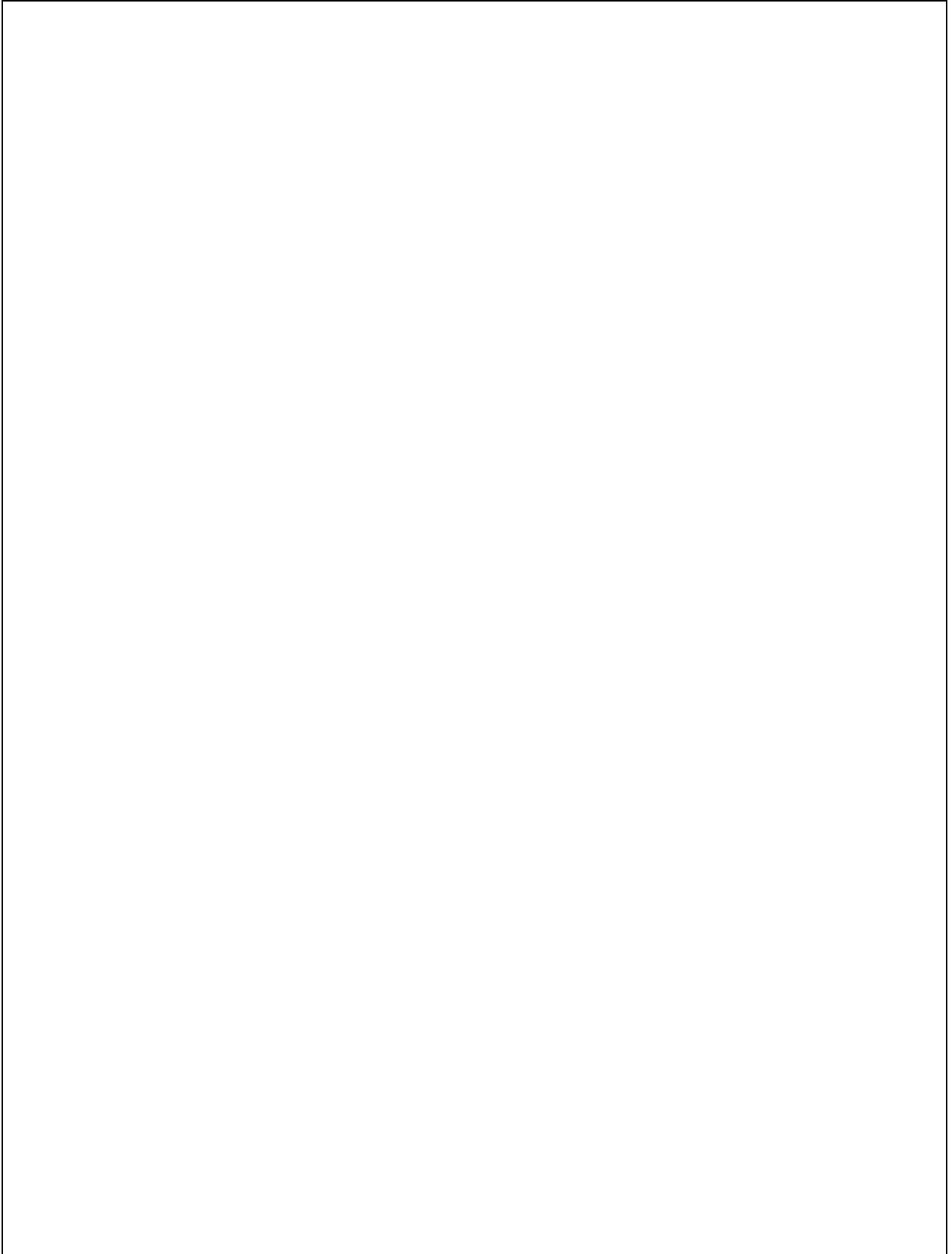
A large, empty rectangular box with a thin black border, occupying most of the page. It is intended for the user to write the content of their memo.