

EXI-310
Inverted Microscope



ACCU-SCOPE®

MICROSCOPY & IMAGING SOLUTIONS



Empowering Discovery. Advancing Results.

Next Generation Microscopy and Imaging Solutions

Your Flexible Biological and Life Science Microscope Platform

As a market leader in quality microscopy and imaging solutions, ACCU-SCOPE blends precision, performance and outstanding value like no other manufacturer can. We deliver superb yet affordable optical instrumentation and microscopy innovations that help advance the work, improve the outcomes and empower the achievements of the demanding professionals we're privileged to serve. No matter your industry, discipline or individual endeavor, count on ACCU-SCOPE microscopy, imaging solutions and accessories to exceed expectation as you achieve your goals.



Image Acquisition

Add a camera* to the EXI-310 and you are ready to capture images and video for documentation and analysis. The front-accessible light path selector efficiently switches from 100% light to the eyes to 80%/20% light to the eyes/camera. Complete your imaging system with a camera from our extensive selection of Excelis and Teledyne Lumenera microscopy cameras.

**requires camera adapter*

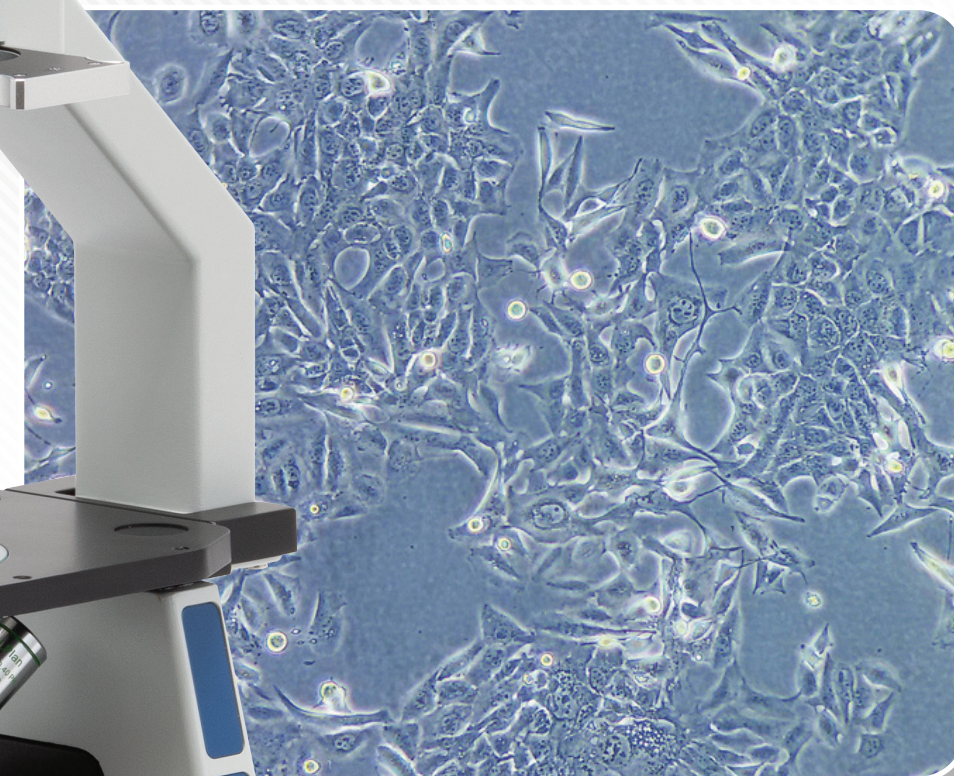
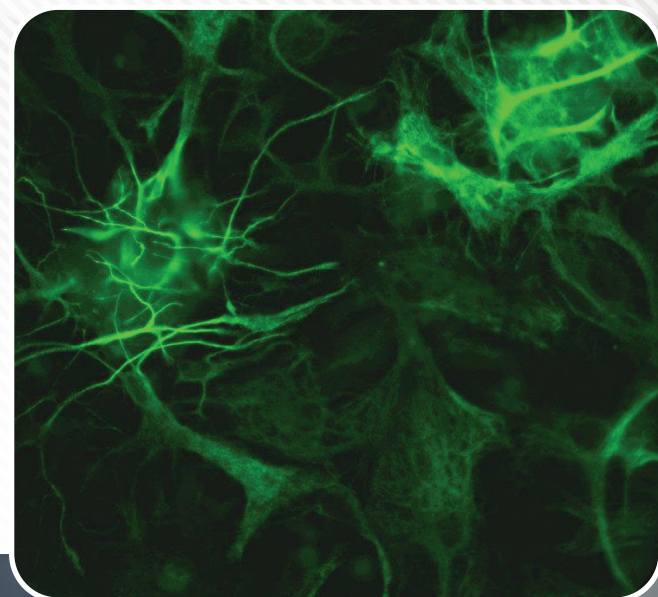
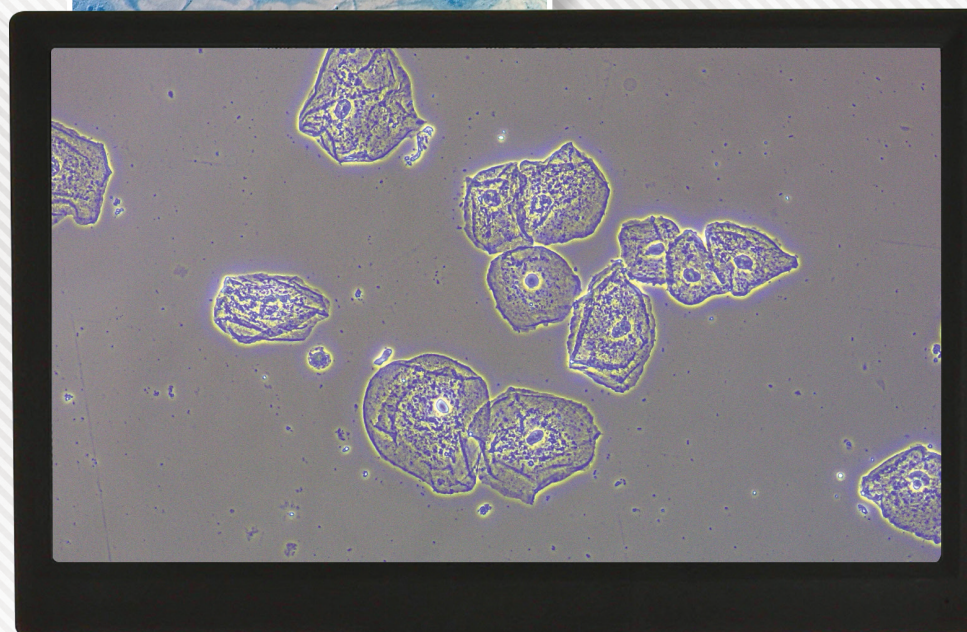
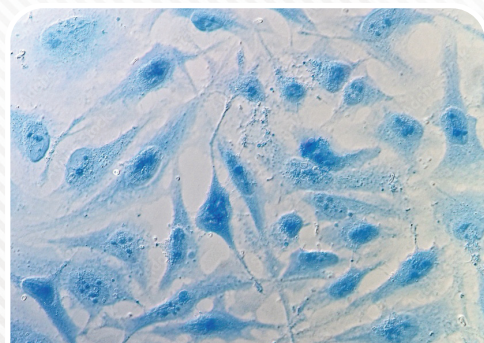

Live Cell Observation

The EXI-310 is available with phase contrast observation for viewing live cells without the need for staining. The phase contrast configuration includes a phase contrast slider, centering telescope, a Plan 4X objective, and 10X and 20X Plan Phase objectives - 4X and 40X Plan Phase objectives are optional accessories. Add the optional mechanical stage and stage inserts to simplify sample movement and positioning.

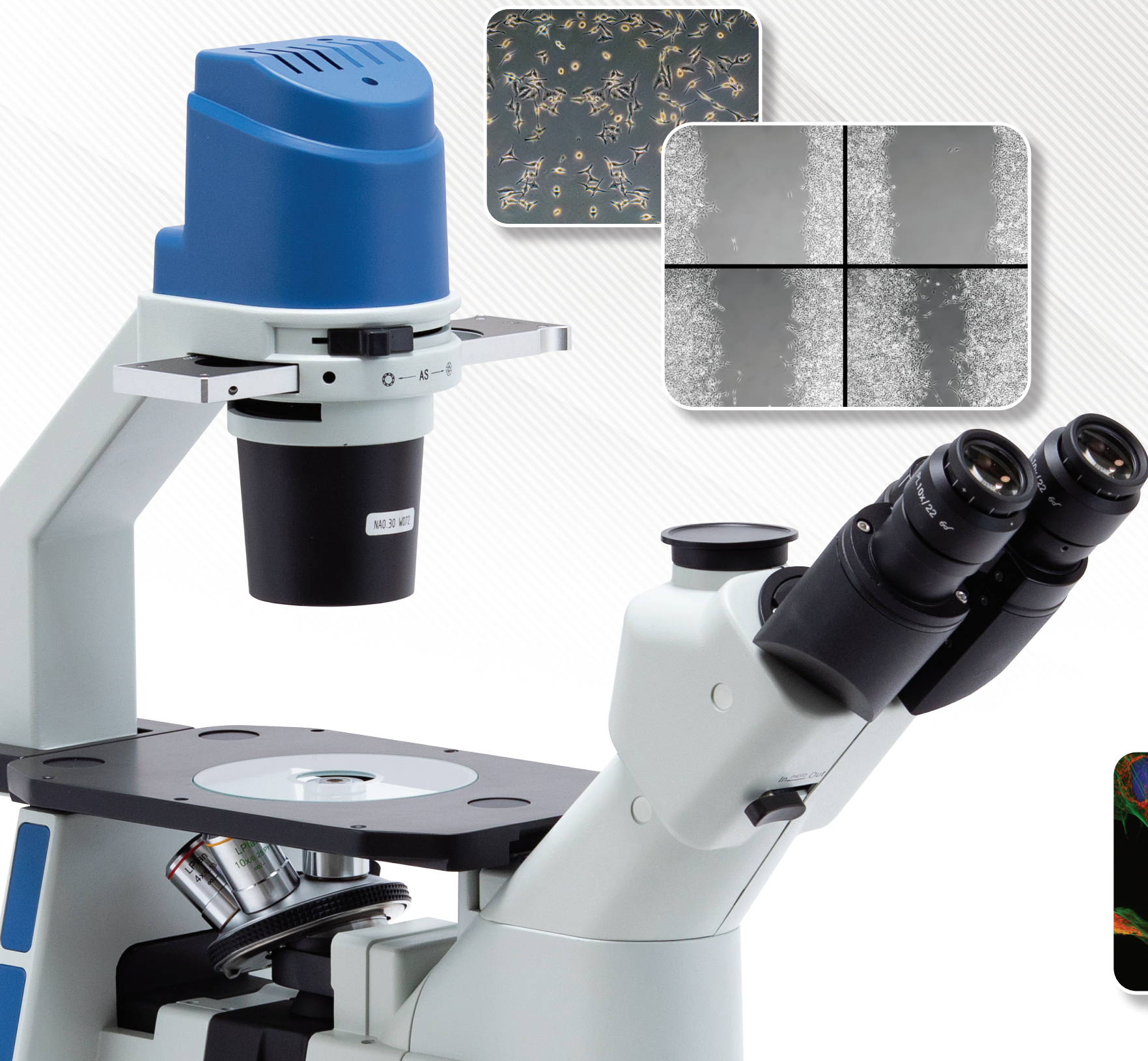

Fluorescence Observation

Available as a standard system solution or purchased as optional accessories, fluorescence observation expands the EXI-310 capabilities for observing live cells expressing fluorescent proteins or fixed cells stained to localize intracellular components. The epi-fluorescence illuminator of the EXI-310 accepts a variety of external fluorescence light sources including the latest solid state light sources.

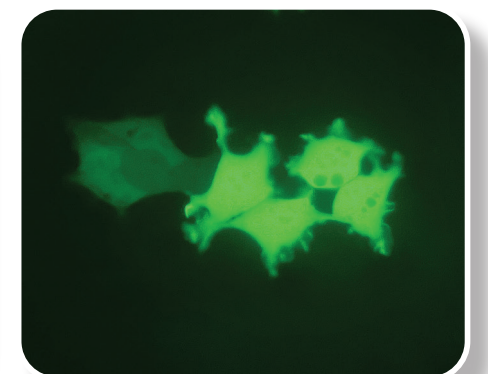
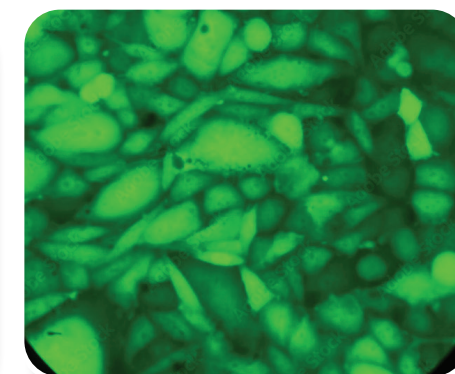
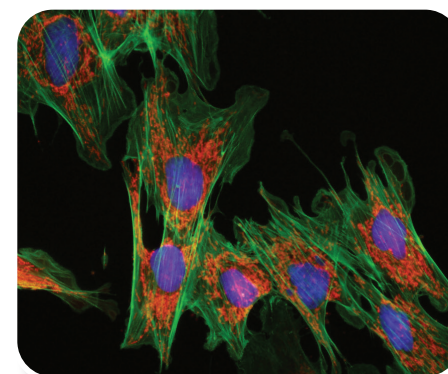

Your Trusted Routine Inverted Microscope

The EXI-310 is your trusted and dependable inverted microscope for routine tissue culture, clinical laboratory observations and teaching applications. The EXI-310 is available in three standard configurations (phase contrast, 2-channel fluorescence, 3-channel fluorescence) or as a fully modular microscope to customize to meet your individual needs.



- 1. 5W transmitted LED
- 2. Phase contrast and interference filter sliders
- 3. Extra long working distance (ELWD) condenser
- 4. Clear glass stage plate
- 5. Optional attachable mechanical stage
- 6. Binocular tubes w/ WF10X/22mm eyepieces
- 7. Trinocular camera port
- 8. Light path selector
- 9. Coaxial coarse and fine focus

- 10. Optional epi-fluorescence illuminator
(epi-fluorescence illuminator dovetail receiver accepts variety of external fluorescence light sources; requires optional 2 or 3 position filter cube holder)
- 11. Optional 2 or 3 position fluorescence filter cube selector (required for fluorescence)
- 12. Shield for epi-fluorescence illuminator
(standard with optional epi-fluorescence illuminator)
- 13. Quintuple nosepiece with long working distance objectives
(selection of Plan, Plan Phase, Plan Fluor, Plan Fluor Phase)
- 14. Variable transmitted light intensity

Wide Selection of Objectives

The EXI-310 has a wide range of available long working-distance objectives to suit most applications.

	NA	WD (mm)	Cover Glass Thickness (mm)	Brightfield	Phase Contrast	Fluorescence
2X LWD Plan	0.06	5.10	–	●		●
4X LWD Plan	0.10	22.0	–	●		●
10X LWD Plan	0.25	7.94	–	●		●
20X LWD Plan	0.40	7.66	1.2	●		●
40X LWD Plan	0.60	3.71	1.2	●		●
60X LWD Plan	0.70	2.50	1.2	●	●	●
4X LWD Plan PH	0.10	22.0	–	●	●	●
10X LWD Plan PH	0.25	7.94	–	●	●	●
20X LWD Plan PH	0.40	7.66	1.2	●	●	●
40X LWD Plan PH	0.60	3.71	1.2	●		●
4X LWD Plan Fluor	0.13	18.52	1.2	●		●
10X LWD Plan Fluor	0.30	7.11	–	●		●
20X LWD Plan Fluor	0.45	5.91	1.2	●		●
40X LWD Plan Fluor	0.65	1.61	1.2	●		●
60X LWD Plan Fluor	0.75	1.04	1.2	●		●
20X LWD Plan Fluor PH	0.45	5.91	1.2	●	●	●
40X LWD Plan Fluor PH	1.61	1.61	1.2	●	●	●



Wide Variety of Accessories

Choose from a selection of stage inserts to match your sample holder.



EXI-310 Routine Inverted Microscope

EXI-310 SPECIFICATIONS

Optical System	AIS Infinity Optical System, anti-fungal
Observation Methods	Brightfield, Phase Contrast, Epi-Fluorescence
Viewing Body	Trinocular inclined 45°; interpupillary distance: 54-75mm, Siedentopf type; Eyepiece/camera port (standard): 100/0:80/20, Fluorescence: 100/0: 0/100
Eyepieces	WF 10x/22mm field of view focusable eyepieces with roll-down eyeguards (optional 15x/16mm and 20x/12.5mm)
Nosepieces	Side facing quintuple nosepiece
Objectives	Select from: LWD Plan Phase 4x, 10x, 20x & 40x; LWD Plan 2x, 4x, 10x, 20x, 40x & 60x; LWD Fluor 4x, 10x, 20x, 40x & 60x; LWD Plan Fluor Phase 20x & 40x
Stage	Fixed plain stage size 160mm x 250 with glass insert plate (optional attachable mechanical stage, right hand coaxial control 120mm x 78mm)
Holders	ø35mm petri dish holder, ø54mm dish and hemocytometer/glass slide holder, Terasaki plate holder
Condenser	ELWD condenser, N.A. 0.3, W.D. 72mm
Slider	Pre-centered phase slider 4x/10x, 20x/40x annuli and BF position; secondary slider for filters for enhanced illumination techniques
Stand	Cast alloy aluminum
Illumination	5 watt LED with variable intensity control; LED bulb is rated for over 25,000 hours of continued use; universal power supply 110-240v
Epi-Fluorescence	LED, Metal Halide or Mercury
Focusing	Coaxial coarse and fine focusing system with adjustable tension control; all brass gears
Accessories	Filters; Green 550nm interference (with Phase units only) and ground glass (optional: 45mm SIF800 infrared interference; ND25 or ND50 filters); Dust cover, instruction manual
Warranty	5 year limited warranty for parts, labor and electronic components 1 year warranty on LED bulbs

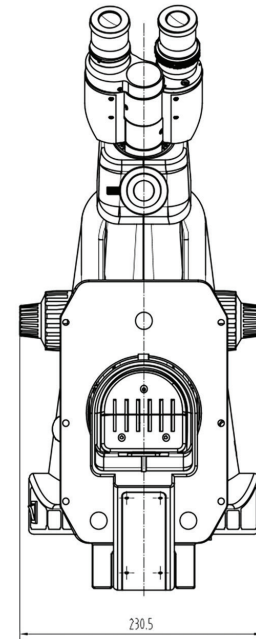
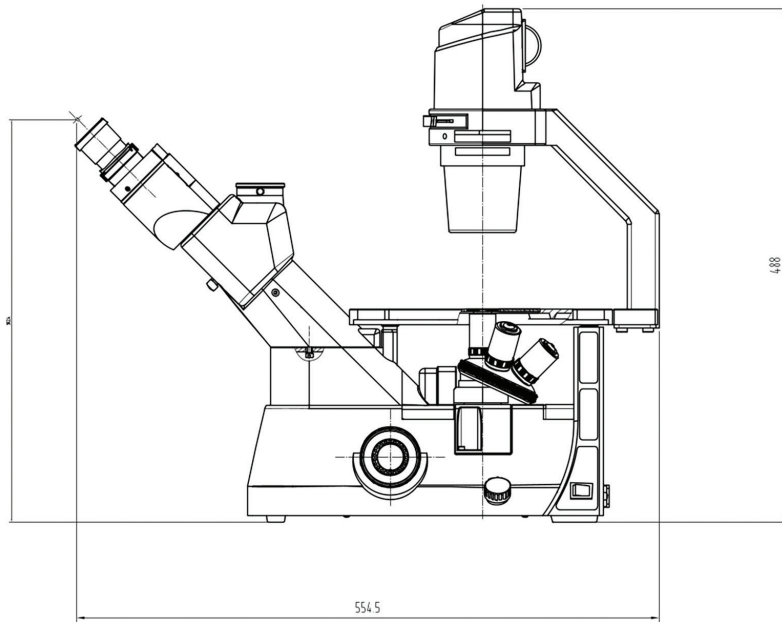

Copyright © 2022 ACCU-SCOPE Inc. All rights reserved. Printed in the U.S.A. ACCU-SCOPE Inc. reserves the right to change and improve specifications without notice due to technological or manufacturing advances.

