

CUTSHEET

Front View

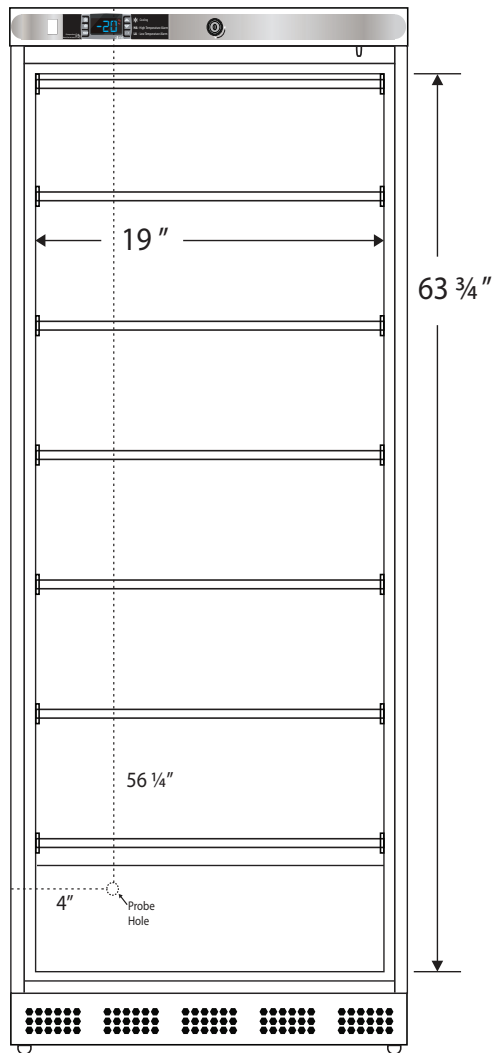

Side View

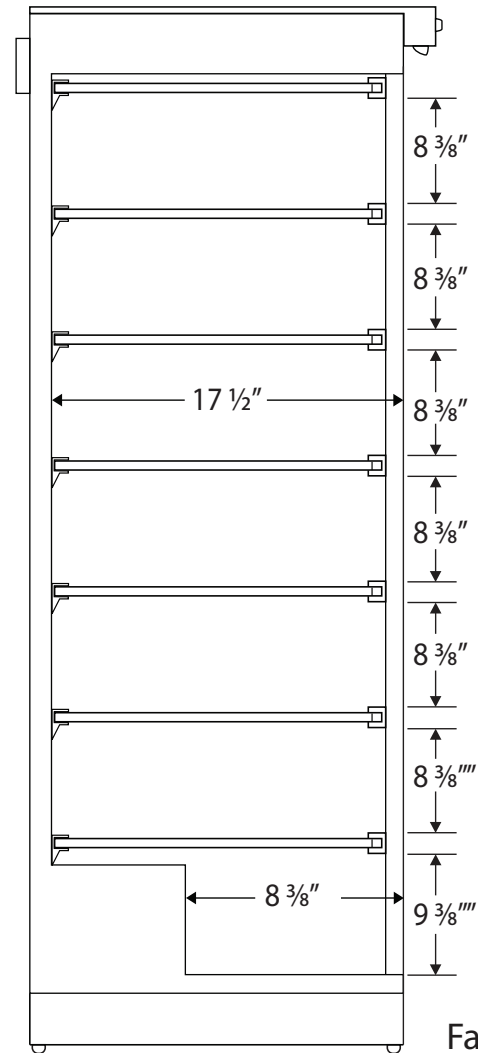

Cu. Ft	Defrost	Door	Int Door	Shelves	Interior Dim.			Refrigerant	H.P.	Amps	Weight
					W"	D"	H"				
14	Manual	1 Solid	0	6 Fixed	19	17 1/2	63 3/4	R290	1/3	3.5	165 lbs.

Note: Interior dimensions are estimates and subject to change without notice