



# ORCA<sup>®</sup>-fire

Digital CMOS camera C16240-20UP

Elemental for Discovery

**HAMAMATSU**

PHOTON IS OUR BUSINESS



The ORCA®-Fire intelligently integrates all the essential elements of a high performance, back-thinned, scientific CMOS (sCMOS) camera. The camera's excellence is rooted in Hamamatsu's dedication to low noise and high quantum efficiency sCMOS technology. With the ORCA®-Fire, high sensitivity is realized while also achieving excellent resolution and blazing fast speeds. The ORCA®-Fire shines when the science demands high throughput but the sample can only deliver a few photons.

**Will the ORCA®-Fire spark your next discovery?**

## Highlight Specs

### LOW NOISE

1.0 electrons rms  
115 frames/s

### HIGH QE

90 % @475 nm  
Back illuminated CMOS

### HIGH RESOLUTION

4432 (H) × 2368 (V)  
Pixel size 4.6 μm

### HIGH SPEED

115 frames/s  
@4432(H)×2368(V) 10.5 Mpixels

### LARGE FIELD OF VIEW

20.4 mm × 10.9 mm  
Diagonal 23.114 mm

### HIGH DYNAMIC RANGE

1 : 20 000  
Full well capacity 20 000 electrons

## SMALL PIXELS, BIG RESOLUTION

### Optimize your optics to maximize resolution

Low mag imaging (<40×) offers the advantage of wide field of view, which can be critical for high throughput applications. To acquire low mag images with maximum information, the imaging system must achieve high resolution by matching pixel size to Nyquist-level or higher sampling rates. The pixel size of the ORCA®-Fire is ideal for most 40× objectives or lower (see chart below). The ORCA®-Fire's high spatial resolution combined with a large pixel array and high speed readout delivers 2.9× higher pixel throughput over even the fastest 4.2 MP 6.5 μm sCMOS camera.

Example of appropriate pixel size of sensor according to objective lens magnification and NA

Magnification	NA	$\delta$ (μm)	$\Delta$ (μm)	Appropriate pixel size (μm)
4	0.16	2.10	8.4	4.2
10	0.4	0.84	8.4	4.2
20	0.8	0.42	8.4	4.2
40	1.4	0.24	9.6	4.8
40	0.95	0.35	14.1	7.1
60	1.42	0.24	14.2	7.1
100	1.5	0.22	22.4	11.2

- \* Rayleigh criterion ( $\delta$ ) =  $0.61 \lambda / NA$
- \* Wavelength ( $\lambda$ ) = 550 nm
- \*  $\Delta$  =  $\delta \times$  Magnification of objective lens

### Comparison of image quality at different pixel sizes

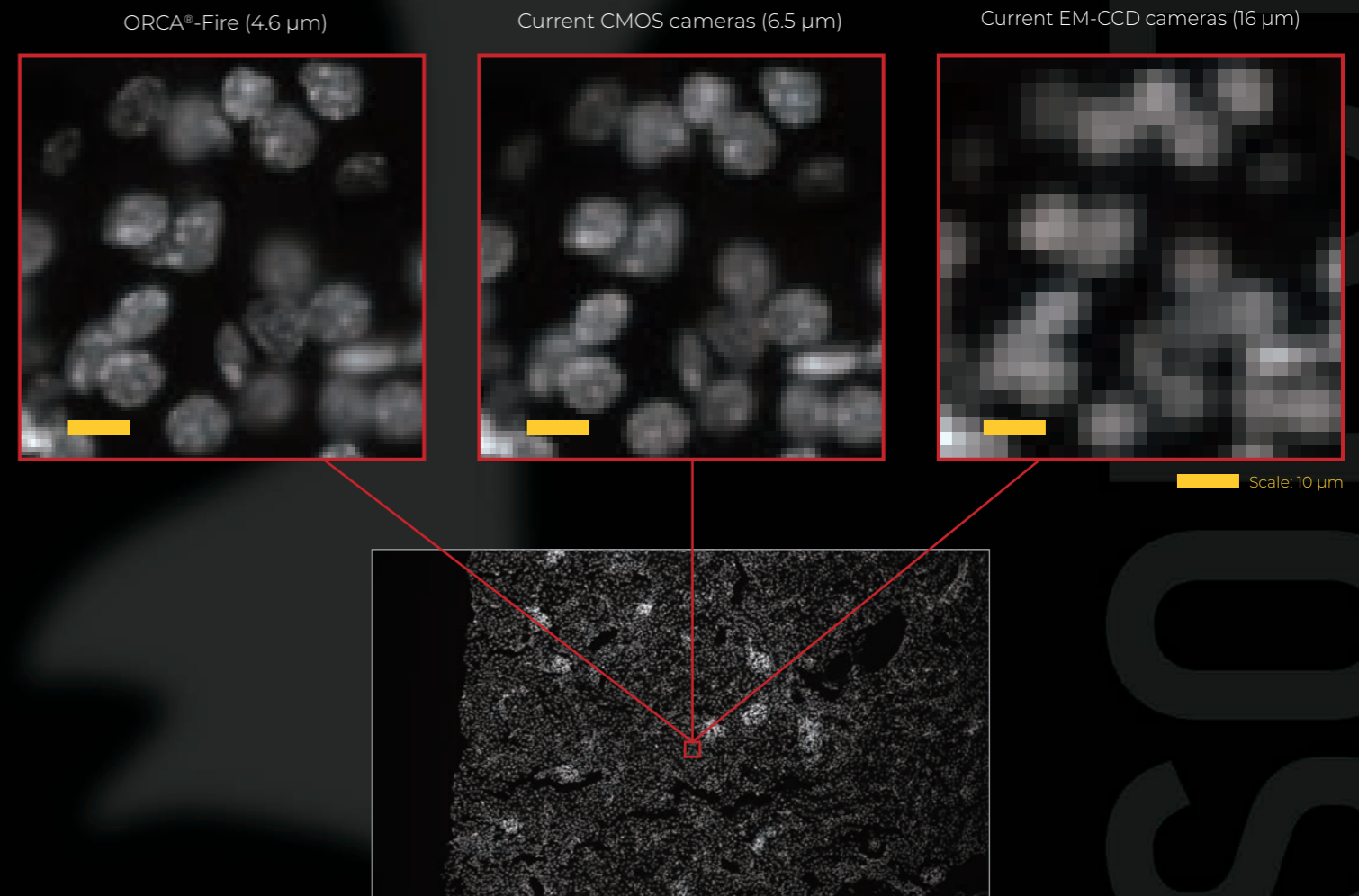

Objective lens: Plan Apo 10× / 0.45  
 Sample: FluoCells™ Prepared slide #3 mouse kidney section (DAPI)

HIGH QE & LOW NOISE

Realize high sensitivity without sacrifice

The ORCA®-Fire uses advanced back-thinned technology with micro-lenses to achieve high quantum efficiency. Combined with readout noise of 1.0 e<sup>-</sup> rms, the ORCA®-Fire continues Hamamatsu's trend of providing sCMOS cameras that offer paramount sensitivity at all light levels.

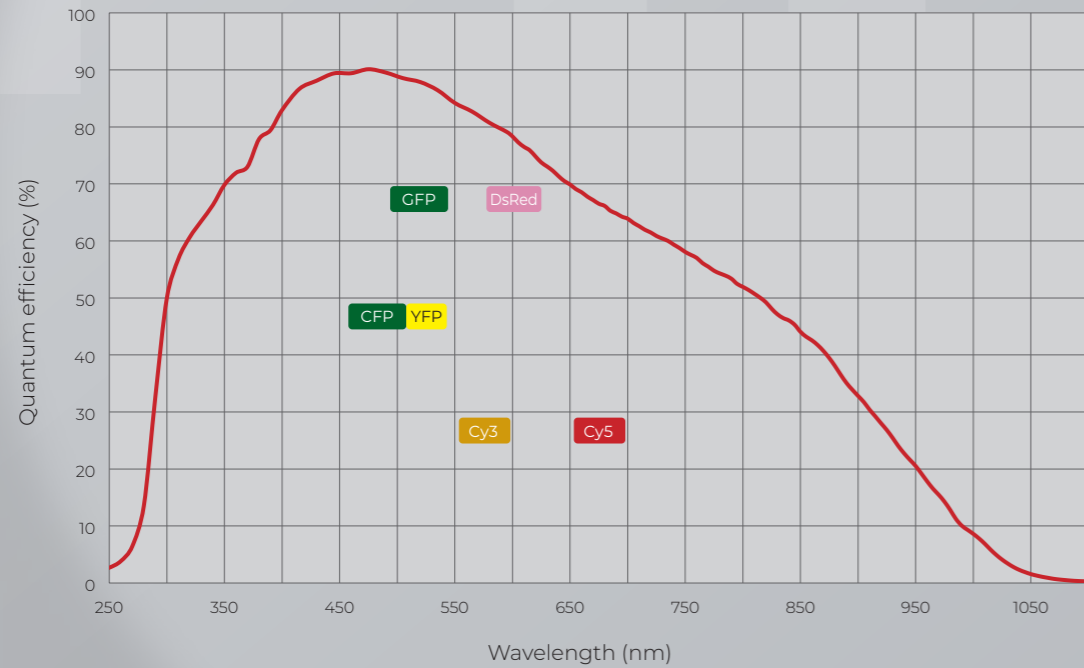

Readout noise distributions

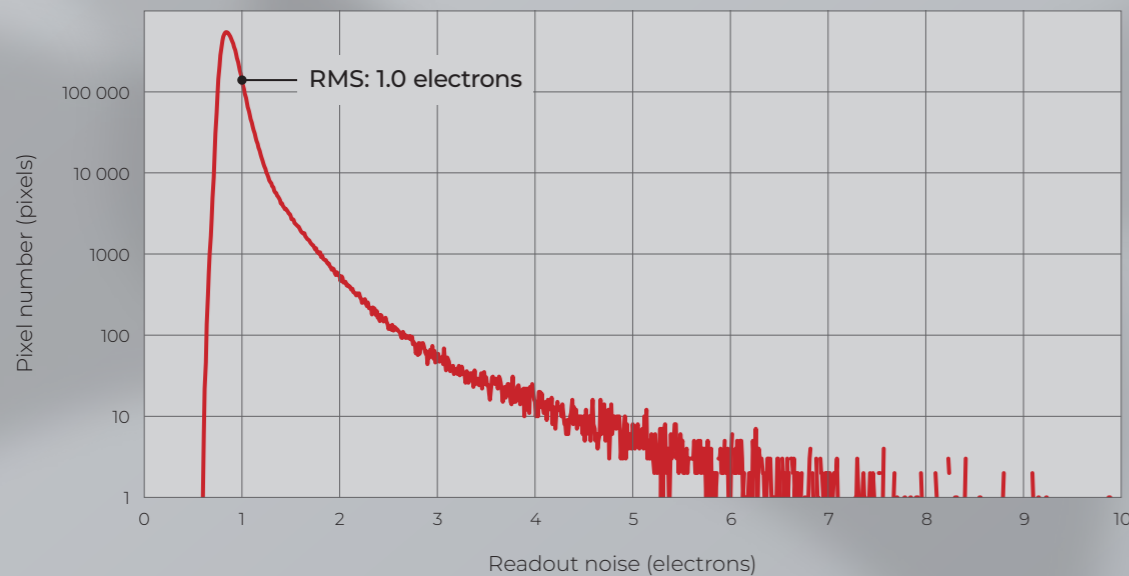

Deep trench structure and backthinning

High QE is a fundamental expectation and a critical component of high sensitivity imaging. Achieving high QE through sensor backthinning seems straightforward however there are nuances in backthinned sensor design that can impact image quality. In conventional back-illuminated detectors, crosstalk occurs between pixels due to poor pixel separation within the active region of the silicon, impairing resolution independent of pixel size. Our engineers implemented a deep trench pixel structure in the ORCA®-Fire that prevents pixel crosstalk and improves resolution.

What is a trench structure?

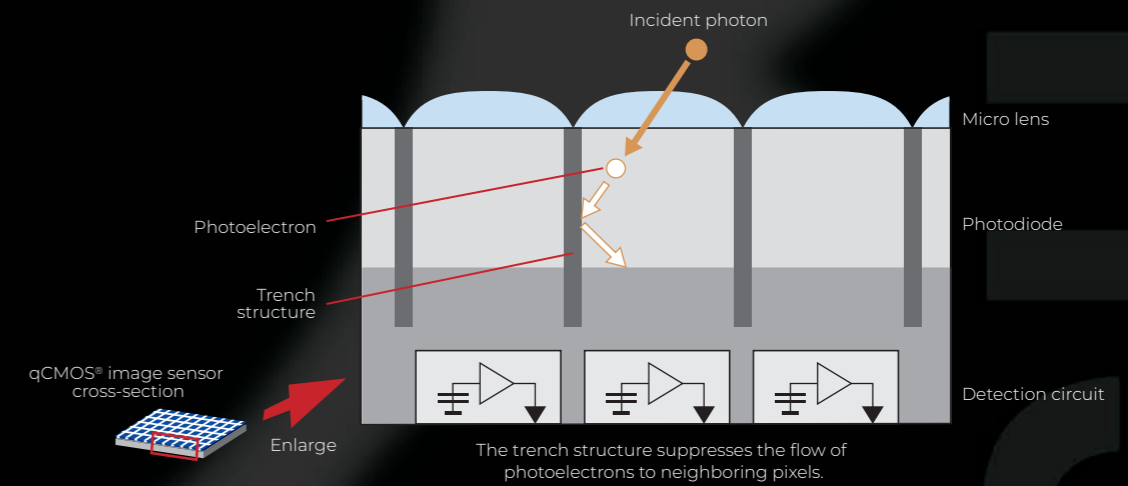

Measurement result of MTF

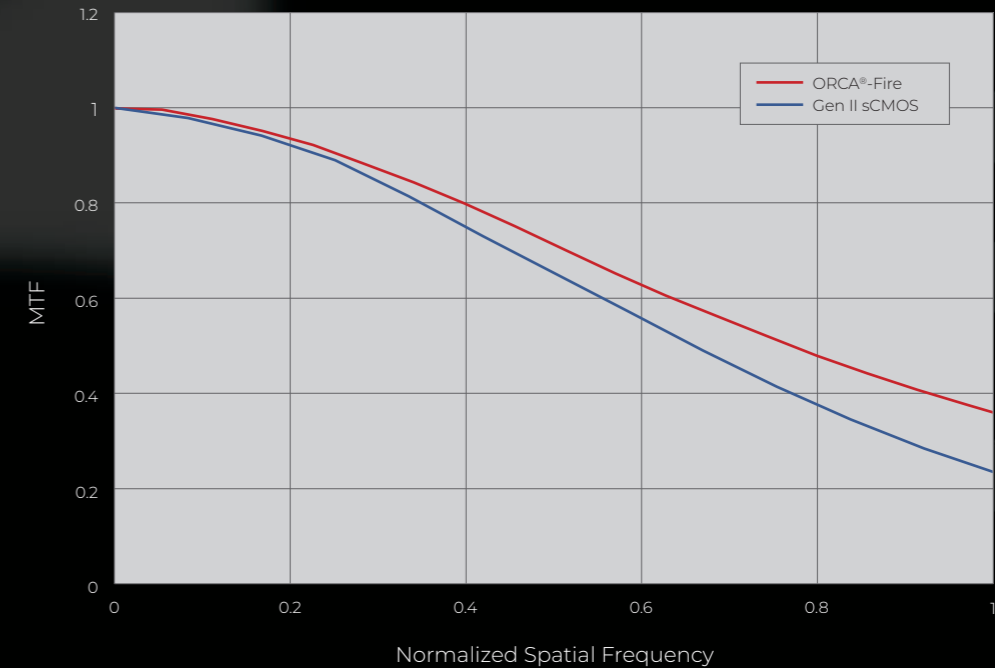

\*Modulation Transfer Function (MTF) is a type of resolution evaluation. It is the value of how accurately the contrast of an object can be reproduced.

### SELECT YOUR SPEED

Every ORCA®-Fire has CoaXPress and USB connectivity

Readout speed (frames/s)

Readout Mode		Area Readout Mode		
Scan Mode		Standard scan		
X (pixels)	Y (pixels)	CoaXPress	USB3.1 Gen I (16 bit)	USB3.1 Gen I (8 bit)
4432	2368	115	15.7	31.5
4432	2304	118	16.2	32.4
4432	2048	132	18.2	36.5
4432	1024	264	36.4	72.8
4432	512	524	72.3	144
4432	256	1020	143	286
4432	128	1980	279	558
4432	8	15 200	2360	5260
4432	4	19 500	3690	7200

Readout speed (frames/s) at 2x2 binning

Readout Mode		Area Readout Mode		
Scan Mode		Standard scan		
X (pixels)	Y (pixels)	CoaXPress	USB3.1 Gen I (16 bit)	USB3.1 Gen I (8 bit)
2216	1184	115	63.1	115
2216	1152	118	64.9	118
2216	1024	132	73	132
2216	512	264	145	264
2216	256	524	289	524
2216	128	1020	572	1020
2216	64	1980	1110	1980
2216	4	15 200	10 500	15 200
2216	2	19 500	13 600	19 500

Mega pixels per second

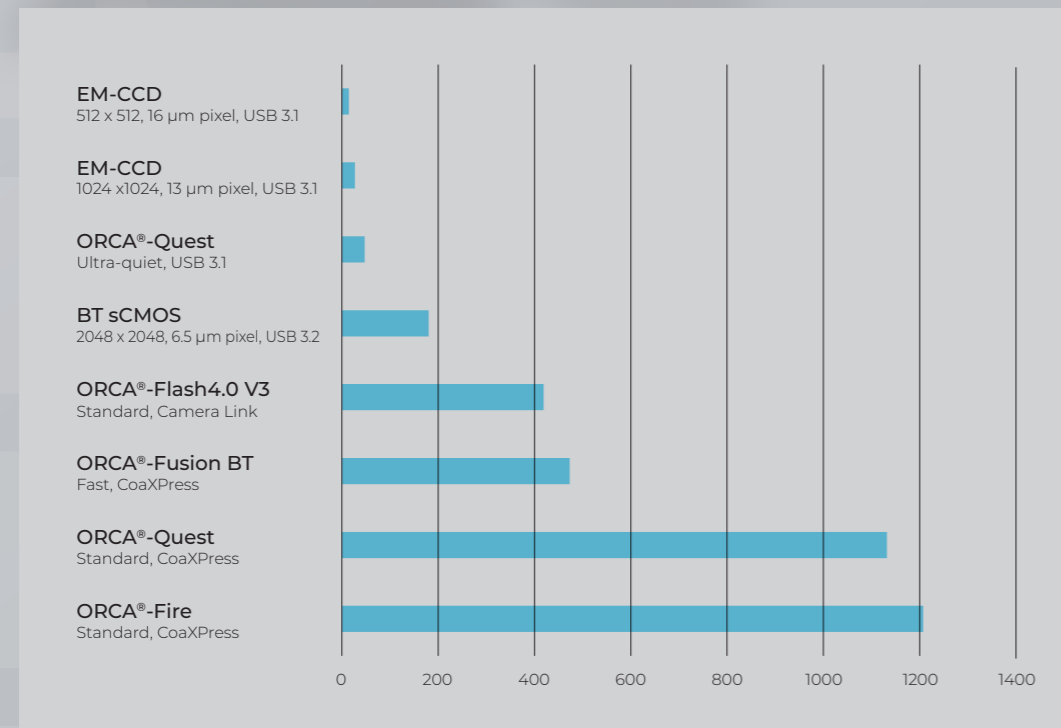

### EXPAND YOUR VISION

Field of view comparison

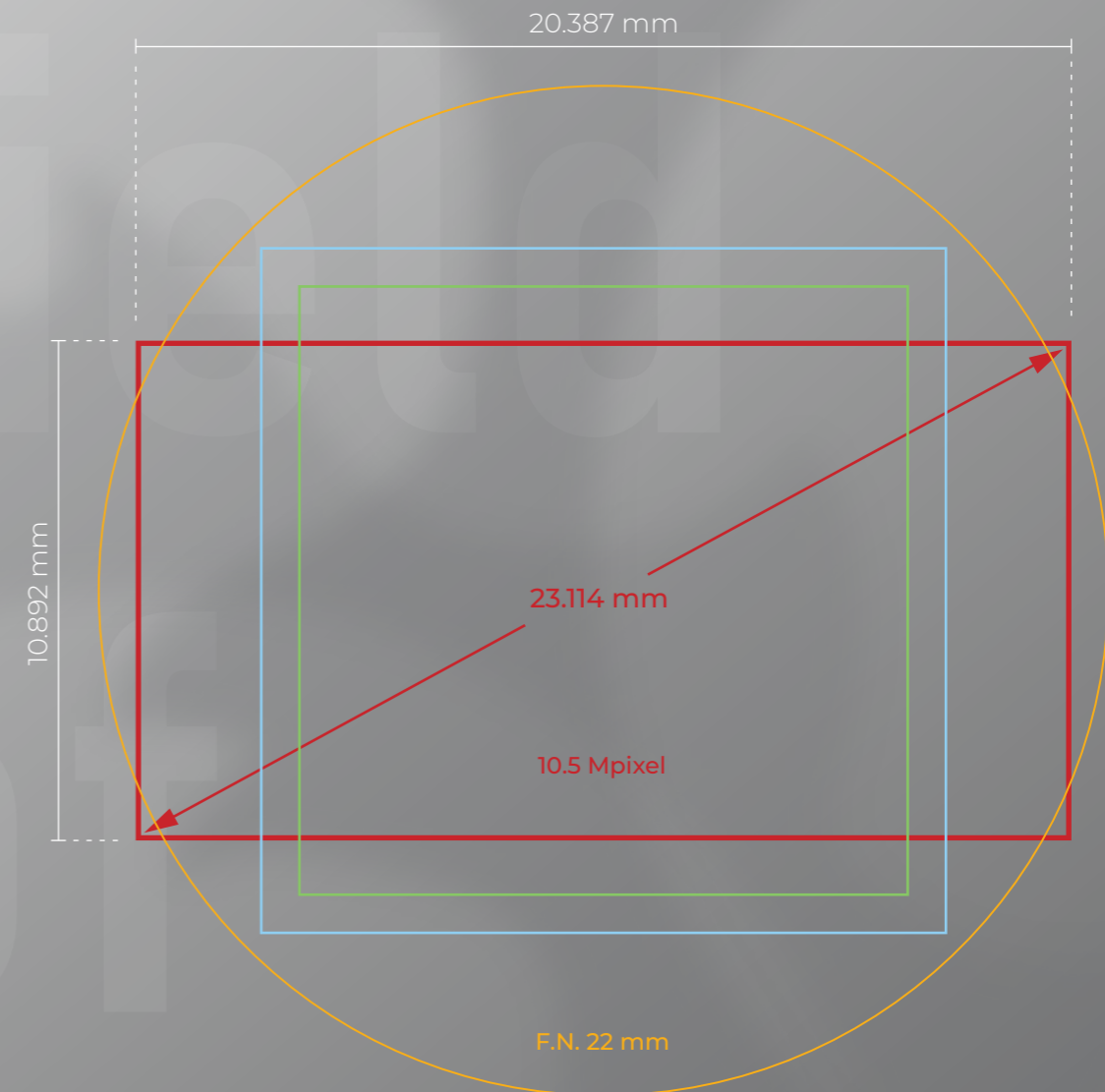

- ORCA®-Fire: 4432(H) × 2368(V)
- GenIII sCMOS: 2304(H) × 2304(V)
- GenII sCMOS: 2048(H) × 2048(V)
- Microscope adapter

With 4432 (H) × 2368 (V) pixels, the ORCA®-Fire can effectively utilize a 22 mm microscope field of view.

**SPECIALIZED FOR THE SPECIALIST**

Lightsheet readout mode reduces scattered light effects

Researchers are increasingly turning to fluorescence lightsheet microscopy to study biological processes in living cells and organisms and to capture stunning 3D resolution of cleared tissue. There are many flavors of lightsheet microscopy but generally the sample is illuminated orthogonally using a “sheet” of light. This sheet is then scanned across the sample to obtain optical cross-sectional images that can be reassembled into full 3D renderings. The ORCA®-Fire implements Hamamatsu’s patented lightsheet readout mode. In this mode, the lightsheet is synchronized with readout of the sensor, reducing the impact of scattered light and effectively improving image quality and signal to noise.

Result of lightsheet readout function

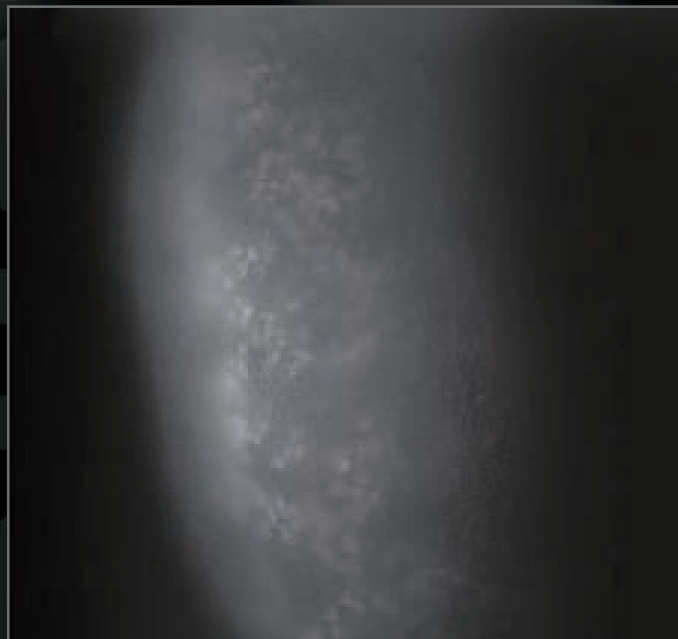

Global shutter image



Lightsheet readout mode image

Data courtesy: Dr. Hufnagel, Dr. Krzic (EMBL Heidelberg, Germany)

Lightsheet readout mode frame rates (frames/s)

Readout Mode Scan Mode		Lightsheet Readout Mode Standard scan		
X(pixels)	Y(pixels)	CoaXPress	USB3.1 Gen I (16 bit)	USB3.1 Gen I (8 bit)
4432	2368	114	15.7	31.5
4432	2304	117	16.2	32.4
4432	2048	132	18.2	36.5
4432	1024	263	36.4	72.8
4432	512	518	72.3	144
4432	256	1000	143	286
4432	128	1900	279	558
4432	8	11 400	2630	5260
4432	4	13 600	3690	7200

sCMOS lightsheet readout mode comparison

Effective pixel numbers (H) × (V)	Readout speed (frames/s)		
	ORCA®-Fire (CoaXPress)	ORCA®-Fusion	ORCA®-Flash4.0 V3
4432 × 2368	114	–	–
2304 × 2304	117	88.9	–
2048 × 2048	132	100	49
1024 × 1024	263	199	99
512 × 512	518	396	196
256 × 256	1000	784	384
128 × 128	1900	1540	738

Interface: CoaXPress/Camera Link  
Image capture mode: Internal synchronous mode

The ORCA®-Fire, in lightsheet readout mode, delivers 2.5× more pixels per second that even the fastest low noise sCMOS camera.

FOR researchers

## SYNCHRONIZE IN ANY DIRECTION

### Bidirectional readout eliminates lag between frames

In the ORCA®-Fire, lightsheet readout has four distinct operational modes: forward, backward, bidirectional and reverse bidirectional. In forward mode the readout begins at the top and progresses to the bottom of the sensor. In backwards mode, the readout is initiated from the bottom and ends at the top. Bidirectional mode begins with forward readout in the first frame and switches to backwards readout in the next frame, continuing this alternating pattern frame by frame. As the name suggests, backwards bidirectional mode, begins with the bottom to top backwards readout in the first frame and switches to top to bottom in the next and so on. Both bidirectional modes were implemented to avoid the lag time required to return to the lightsheet to the top or bottom of the sensor for the next frame.

Forward mode (Top to Bottom)

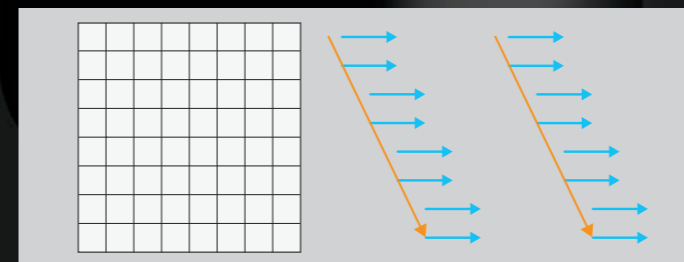

Backward (Bottom to Top)

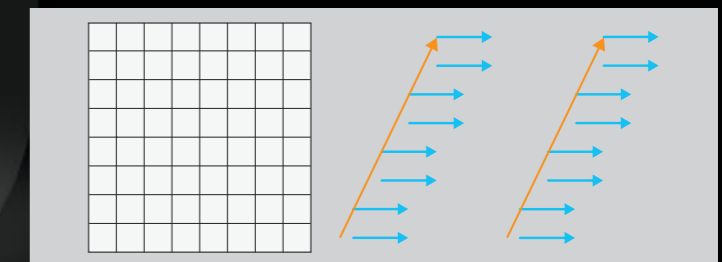

Bidirectional mode

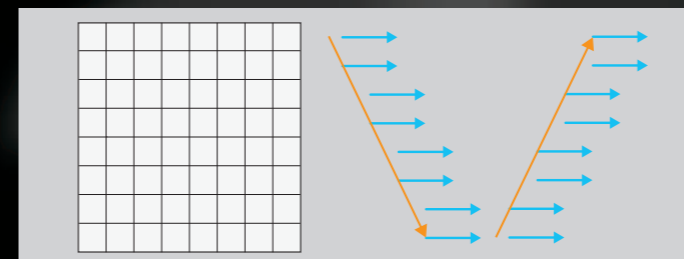

Reverse Bidirectional Mode

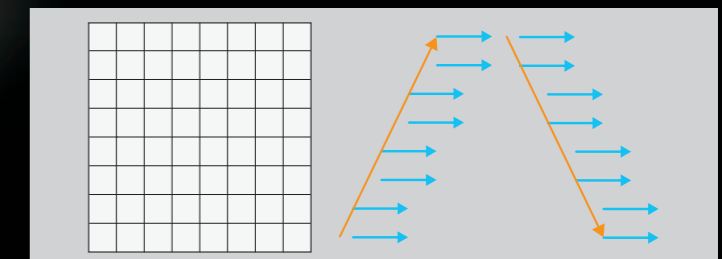

For more information

What is Lightsheet Readout Mode?



## Specifications

Product number	C16240-20UP	
Imaging device	Scientific CMOS image sensor	
Effective number of pixels	4432 (H) × 2368 (V)	
Pixel size	4.6 μm × 4.6 μm	
Effective area	20.387 mm × 10.892 mm	
Full well capacity (Typ.)	20 000 electrons	
Readout noise (Typ.)	1.0 electrons (rms), 0.9 electrons (median)	
Quantum efficiency (Typ.)	90 % (peak QE)	
Dynamic range *1	20 000:1 (rms), 22 222:1 (median)	
Dark signal non-uniformity (DSNU) (Typ.)	0.07 electrons	
Photoresponse non-uniformity (PRNU) *2 10 000 electrons (Typ.)	Less than 0.4 %	
Linearity error EMVA 1288 standard (Typ.)	0.5 %	
Sensor mode	Area readout / Lightsheet readout	
Cooling method (Peltier cooling)	Sensor temperature	Dark current (Typ.)
Forced-air cooled (Ambient temperature: +25 °C)	+20 °C	0.6 electrons/pixel/s
Readout speed *3	CoaXPress	USB 3.1
Full resolution	115 frames/s	15.7 frames/s
Vertical 4 line	19 500 frames/s	3690 frames/s
Area readout	Readout mode	
	Full resolution / Digital binning *4 / Sub-array *5	
Lightsheet readout	Readout mode	
	Sub-array *5	
	Line interval (IH) changeable	
	7.309 μs to 233.9 μs	
	Readout time	
	8.695 ms to 276.9 ms	
	Readout direction	
	Forward readout / Backward readout / Bidirectional readout / Reverse bidirectional readout	
Digital output	16 bit / 8 bit	
Exposure time	7.309 μs to 10 s (7.309 μs step)	
Interface	CoaXPress (Quad CXP-6) / USB 3.1 Gen 1	
Lens mount	C-mount	
Master pulse	Pulse mode	Internal synchronization / Start trigger / Burst
	Pulse interval	5 μs to 10 s (1 μs step)
	Burst count	1 to 65 535
Image processing function	Dark offset correction (always ON), Pixel gain correction (always ON), Defect pixel correction (ON or OFF, hot pixel correction 3 steps)	
Power supply	AC 100 V to AC 240 V, 50 Hz/60 Hz, 2.5 A	
Power consumption	100 VA	
Ambient operating temperature	0 °C to +40 °C	
Ambient operating humidity	30 % to 80 % or less (With no condensation)	
Ambient storage temperature	-10 °C to +50 °C	
Ambient storage humidity	90 % or less (With no condensation)	
Trigger input	External trigger function	
	Area readout mode	Edge trigger / Global reset edge trigger / Level trigger / Global reset level trigger / Sync readout trigger / Start trigger
	Lightsheet readout mode	Edge trigger / Start trigger
	Software trigger function	Area readout mode: Edge trigger / Start trigger Lightsheet readout mode: Edge trigger / Global reset edge trigger / Start trigger
	External trigger signal	External input (SMA)
	External trigger level	TTL/3.3 V LVCMOS level
	External trigger delay function	0 μs to 10 s (1 μs step)
Trigger output	External output signal	
	Global exposure timing output / Any-row exposure timing output / Trigger ready output / Programmable timing output / High output / Low output	
	External output level	3.3 V LVCMOS level

\*1 Calculated from the ratio of the full well capacity and the readout noise

\*2 The center 1500 × 1500 area of the image sensor, 1000 times integration

\*3 Using frame bundle function by DCAM-API

\*4 Only for the digital binning 2×2, 4×4 and area readout mode

\*5 Sub-array readout mode can be set in the following steps when used with DCAM-API

	Horizontal size	Vertical size	Horizontal position	Vertical position
Area readout mode	4 pixel step	4 line step	4 pixel step	4 line step
Lightsheet readout mode	1 pixel step	4 line step	1 pixel step	4 line step

## System configurations

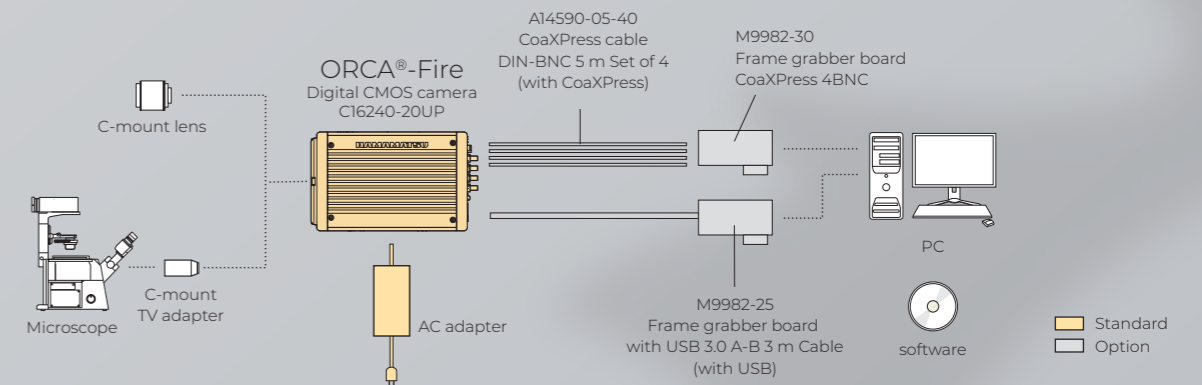

## Dimensional outlines (Unit: mm)

Camera (Approx. 1.4 kg)

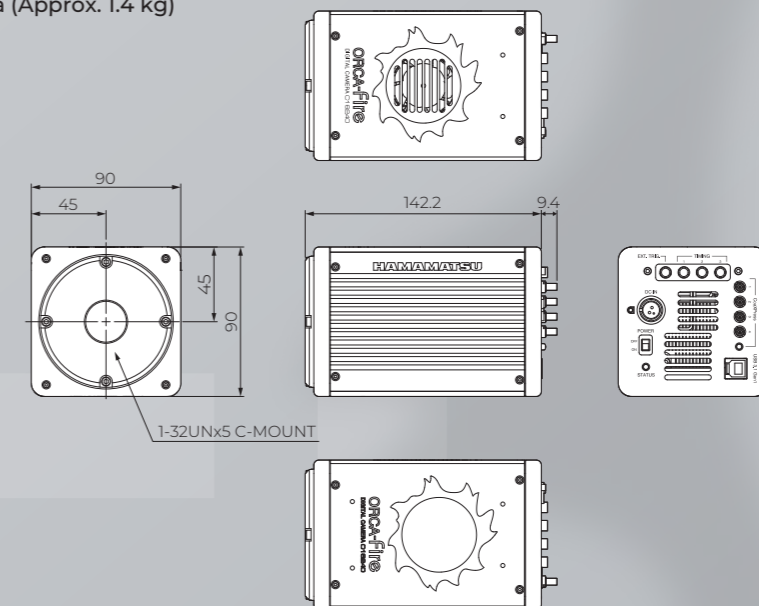

## Options

External trigger cable SMA-BNC 5 m	A12106-05
External trigger cable SMA-SMA 5 m	A12107-05
Frame grabber board CoaXPress 4BNC	M9982-30
CoaXPress cable DIN-BNC 5 m Set of 4	A14590-05-40
Frame grabber board with USB 3.0 A-B 3 m Cable	M9982-25
USB 3.0 cable A-B 3 m	A12467-03



# HAMAMATSU

PHOTON IS OUR BUSINESS

- ORCA is a registered trademark of Hamamatsu Photonics K.K. (China, France, Germany, Japan, UK, USA)
- qCMOS is a registered trademark of Hamamatsu Photonics K.K. (China, EU, Japan, UK, USA)
- The product and software package names noted in this brochure are trademarks or registered trademarks of their respective manufactures.
- Subject to local technical requirements and regulations, availability of products included in this brochure may vary. Please consult your local sales representative.
- The product described in this brochure is designed to meet the written specifications, when used strictly in accordance with all instructions.
- The university, institute, or company name of the researchers, whose measurement data is published in this brochure, is subject to change.
- The spectral response specified in this brochure is typical value and not guaranteed.
- Specifications and external appearance are subject to change without notice.

© 2023 Hamamatsu Photonics K.K.

---

## HAMAMATSU PHOTONICS K.K. [www.hamamatsu.com](http://www.hamamatsu.com)

---

### Systems Division

812 Joko-cho, Higashi-ku, Hamamatsu City, 431-3196, Japan, Telephone: (81)53-431-0124, Fax: (81)53-433-8031, E-mail: [export@sys.hpk.co.jp](mailto:export@sys.hpk.co.jp)

U.S.A.: HAMAMATSU CORPORATION: 360 Foothill Road, Bridgewater, NJ 08807, U.S.A., Telephone: (1)908-231-0960, Fax: (1)908-231-1218

Germany: HAMAMATSU PHOTONICS DEUTSCHLAND GMBH: Arzbergerstr. 10, 82211 Herrsching am Ammersee, Germany, Telephone: (49)8152-375-0, Fax: (49)8152-265-8 E-mail: [info@hamamatsu.de](mailto:info@hamamatsu.de)

France: HAMAMATSU PHOTONICS FRANCE S.A.R.L.: 19 Rue du Saule Trapu, Parc du Moulin de Massy, 91882 Massy Cedex, France, Telephone: (33)1 69 53 71 00, Fax: (33)1 69 53 71 10 E-mail: [infos@hamamatsu.fr](mailto:infos@hamamatsu.fr)

United Kingdom: HAMAMATSU PHOTONICS UK LIMITED: 2 Howard Court, 10 Tewin Road, Welwyn Garden City, Hertfordshire, AL7 1BW, UK, Telephone: (44)1707-294888, Fax: (44)1707-325777 E-mail: [info@hamamatsu.co.uk](mailto:info@hamamatsu.co.uk)

North Europe: HAMAMATSU PHOTONICS NORDEN AB: Torshamnsgatan 35 16440 Kista, Sweden, Telephone: (46)8-509 031 00, Fax: (46)8-509 031 01 E-mail: [info@hamamatsu.se](mailto:info@hamamatsu.se)

Italy: HAMAMATSU PHOTONICS ITALIA S.R.L.: Strada della Moia, 1 int. 6, 20044 Arese (Milano), Italy, Telephone: (39)02-93 58 17 33, Fax: (39)02-93 58 17 41 E-mail: [info@hamamatsu.it](mailto:info@hamamatsu.it)

China: HAMAMATSU PHOTONICS (CHINA) CO., LTD.: 1201 Tower B, Jiaming Center, 27 Dongsanhuan Bellu, Chaoyang District, 100020 Beijing, P.R. China, Telephone: (86)10-6586-6006, Fax: (86)10-6586-2866 E-mail: [hpc@hamamatsu.com.cn](mailto:hpc@hamamatsu.com.cn)

Taiwan: HAMAMATSU PHOTONICS TAIWAN CO., LTD.: 8F-3, No.158, Section 2, Gongdao 5th Road, East District, Hsinchu, 300, Taiwan R.O.C., Telephone: (886)3-659-0080, Fax: (886)3-659-0081 E-mail: [info@hamamatsu.com.tw](mailto:info@hamamatsu.com.tw)

Cat. No. SCAS0164E01  
APR/2023 HPK  
Created in Japan