

NEW

ORCA[®]-Quest

qCMOS[®] camera C15550-20UP



Photon number resolving

The dawn of a new era in scientific camera evolution

Introducing the new ORCA[®]-Quest – a camera that achieves the ultimate in quantitative imaging.

Since the 1980s, Hamamatsu Photonics has continued to develop high-sensitivity, low-noise cameras using its unique camera design technology and has always contributed to the development of cutting-edge scientific and technological research. Now, in 2021, Hamamatsu Photonics are proud to release the ORCA[®]-Quest with ultimate performance.

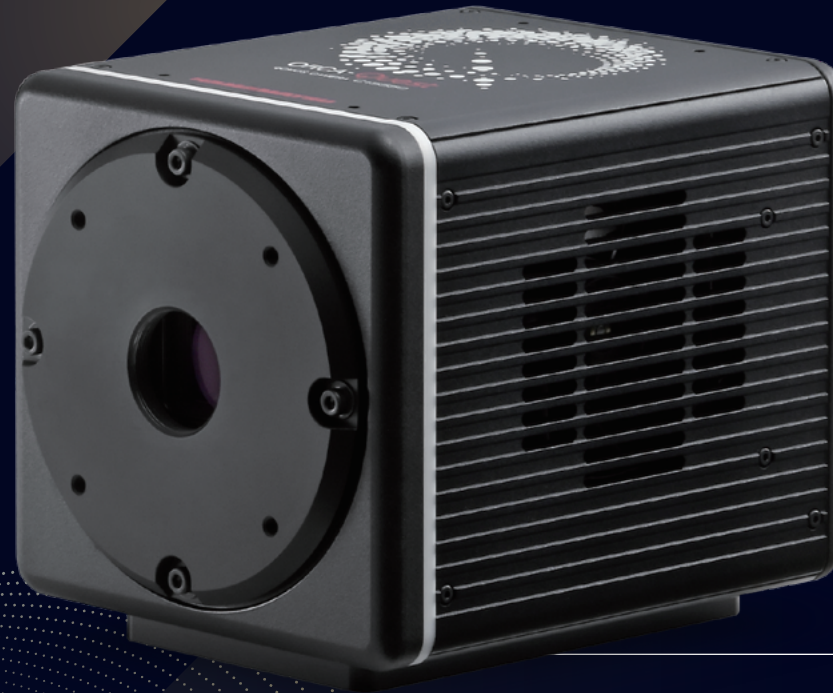

Evolution from single photon counting to photon number resolving

What is qCMOS[®]?

The qCMOS[®] (Quantitative CMOS) is a CMOS image sensor that has the ability to detect and identify the number of both single and multiple photoelectrons. ORCA[®]-Quest is the world's first camera to incorporate the qCMOS[®] image sensor and to be able to resolve the number of photoelectrons using a newly developed dedicated technology. (See page 6)

The world's first qCMOS[®] camera

ORCA[®]-Quest

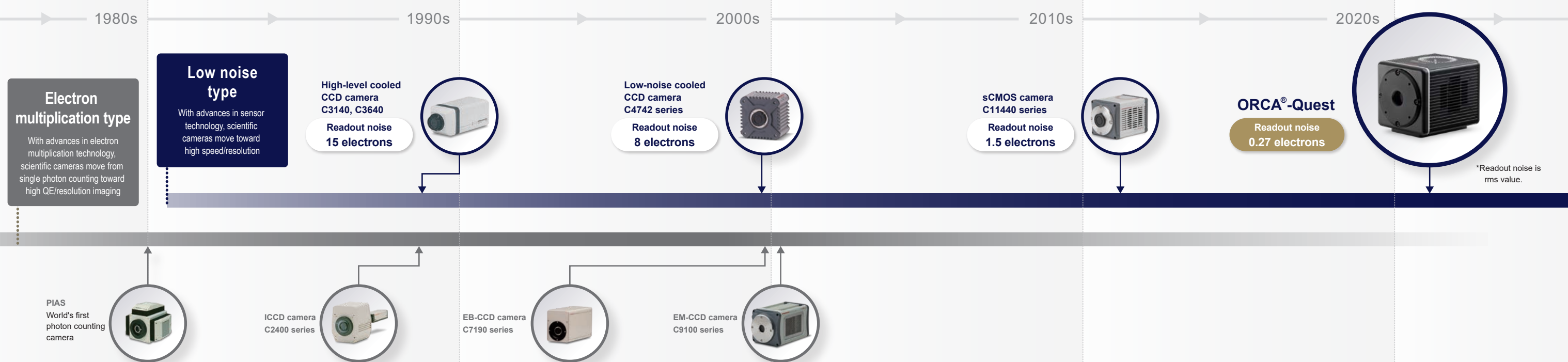

Four key features that enable the ORCA[®]-Quest to achieve ultimate quantitative imaging

1. Extreme low-noise performance
2. Realization of photon number resolving (PNR) output
3. Back-illuminated structure and high resolution
4. Realization of a large number of pixels and high speed readout

1. Extreme low-noise performance

Ultra-low readout noise 0.27 electrons rms at Ultra quiet scan

In order to detect weak light with high signal-to-noise, ORCA[®]-Quest has been designed and optimized to every aspect of the sensor from its structure to its electronics. Not only the camera development but also the custom sensor development has been done with latest CMOS technology, an extremely low noise performance of 0.27 electrons has been achieved.

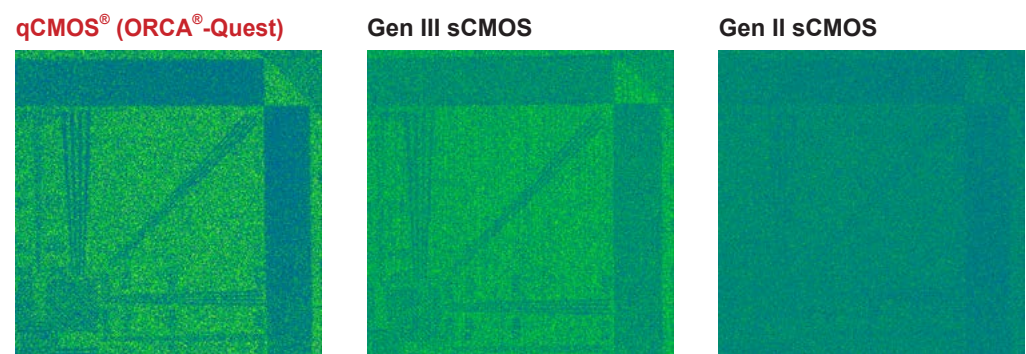
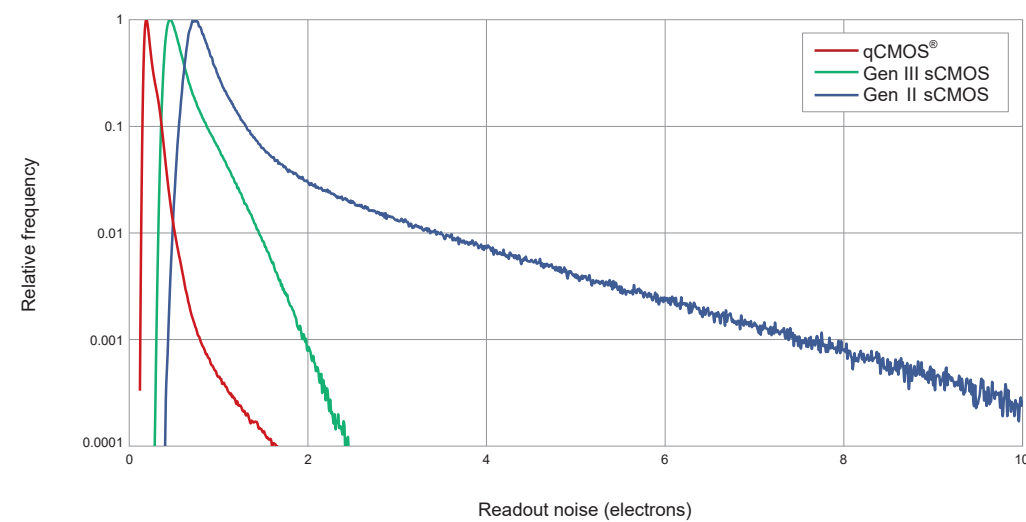

Comparison of average 1 photon per pixel image (pseudo-color)
Exposure time: 200 ms LUT: minimum to maximum value Comparison area: 512 pixels × 512 pixels

Low-dark current 0.006 electrons/pixel/s at -35 °C

In the field of single photon counting and photon number resolving, even dark currents as low as 0.5 electrons/pixel/s can affect photon detection. The 0.006 electrons/pixel/s @-35 °C value achieved by ORCA[®]-Quest is an extremely low probabilistic value of only 1 electron of dark current generated in approximately 167 pixels when exposed for 1 second.

Thus, the ORCA[®]-Quest, which is less affected by dark current, is ideal for quantitative imaging and analysis.

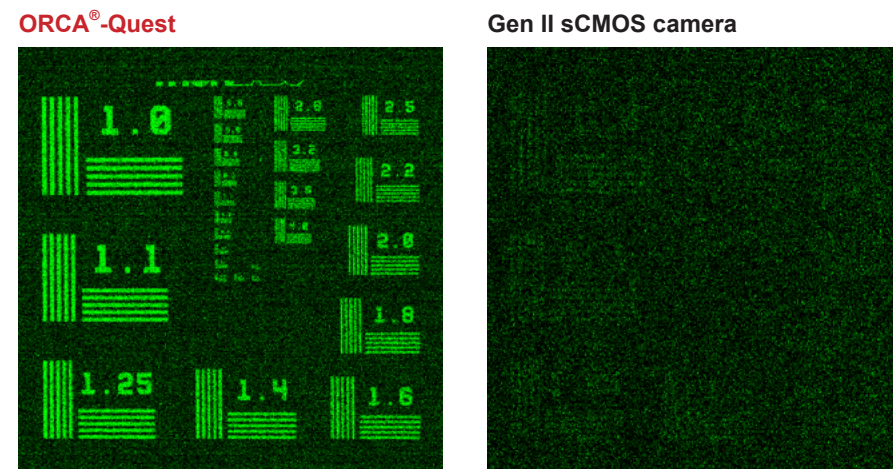

Image quality comparison at long exposure time (pseudo-color)
Incident light intensity: 0.05 photons/pixel/s Exposure time: 15 min (10 s × 90 times integration)

When performing long-time exposure, conventional EM-CCD cameras are easily affected by cosmic rays, and the resulting white spots have become a problem. ORCA[®]-Quest is not easily affected by cosmic rays and can suppress the deterioration of image quality due to white spots during long-time exposure.

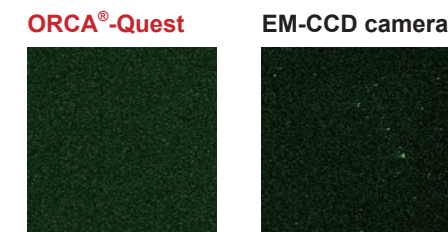

Image quality comparison at long exposure time (pseudo-color)
No incident light Exposure time: 30 min

Four key features that enable the ORCA®-Quest to achieve ultimate quantitative imaging

1. Extreme low-noise performance
2. Realization of photon number resolving (PNR) output
3. Back-illuminated structure and high resolution
4. Realization of a large number of pixels and high speed readout

2. Realization of photon number resolving (PNR) output

Realization of photon number resolving by low-readout noise

Light is a collection of many photons. Photons are converted into electrons on the sensor, and these electrons are called photoelectrons. "Photon number resolving" is a method of accurately measuring light by counting photoelectrons.*

In order to count these photoelectrons, camera noise must be sufficiently smaller than the amount of photoelectron signal. Conventional sCMOS cameras achieve a small readout noise, but still larger than photoelectron signal, making it difficult to count photoelectrons.

Using advanced camera technology, the ORCA®-Quest counts photoelectrons and delivers an ultra-low readout noise of 0.27 electrons rms (@Ultra quiet scan), stability over temperature and time, individual calibration and real-time correction of each pixel value.

For more information about the qCMOS® image sensor, please refer to the ORCA®-Quest white paper.

Simulation data of photoelectron probability distribution (Average number of photoelectrons generated per pixel: 2 electrons)

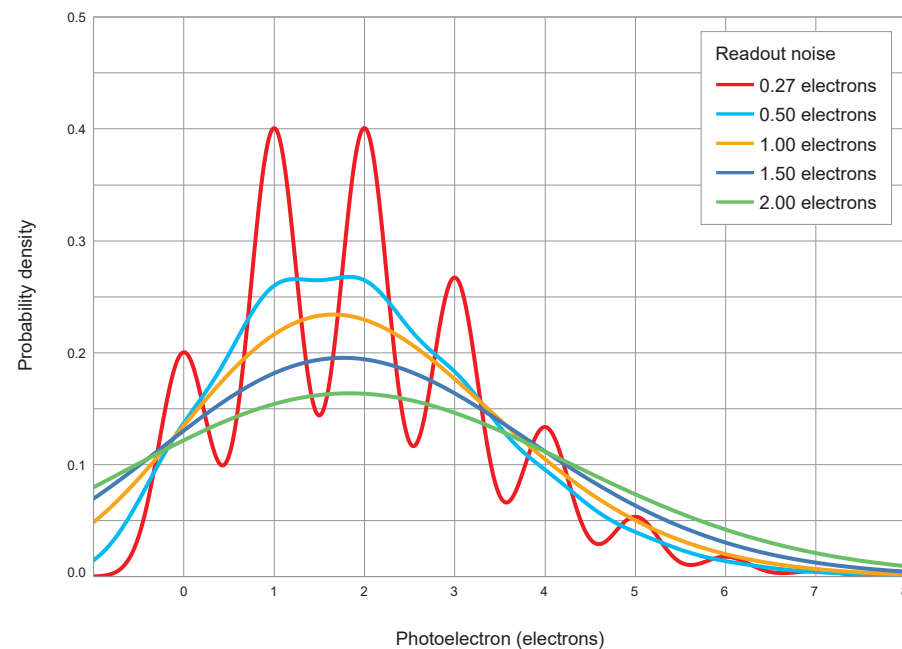

* Photon number resolving is unique and quite different from photon counting (More precisely the method resolves the number of photoelectrons. However, since single photon counting instead of single photoelectron counting has been used for a comparable method in this field, we will use the term "photon number resolving" in this brochure).

Spatial photon number resolving capability

The graphs show simulated histograms when averaged photoelectrons are 3 and 10 electrons/pixel. While the EM-CCD and Gen II sCMOS cameras cannot realize the photon number resolving due to multiplication noise or higher readout noise, the ORCA®-Quest realizes spatial photon number resolving in addition to temporal photon number resolving. Furthermore, it follows Poisson distributions corresponding with averaged photoelectrons of 3 and 10 electrons/pixel.

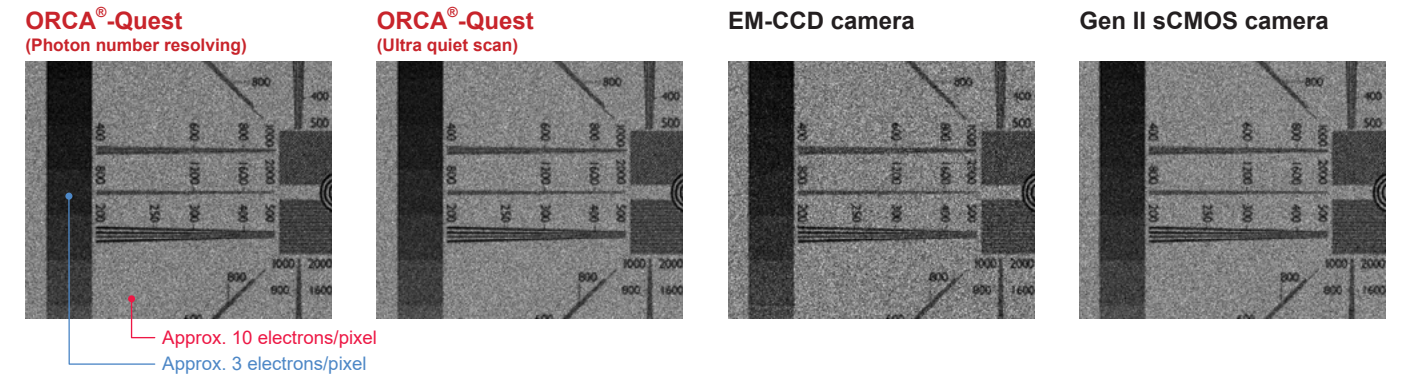

Average number of photoelectrons generated per pixel: 3 electrons

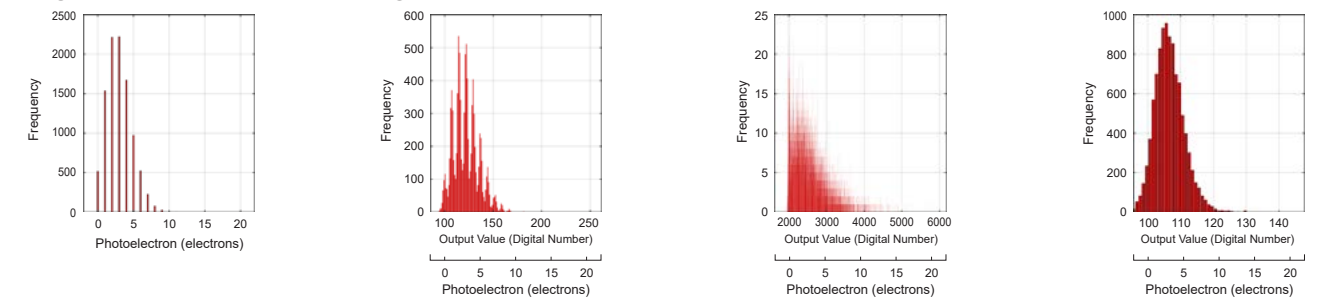

Average number of photoelectrons generated per pixel: 10 electrons

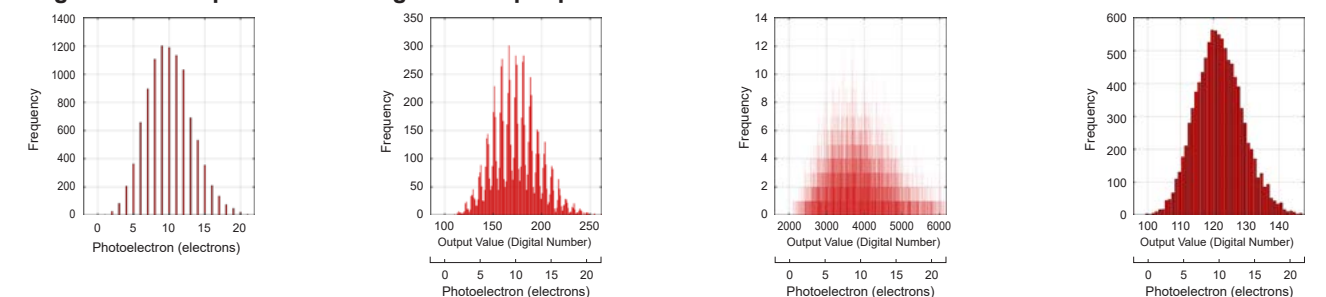

Four key features that enable the ORCA[®]-Quest to achieve ultimate quantitative imaging

1. Extreme low-noise performance
2. Realization of photon number resolving (PNR) output
3. Back-illuminated structure and high resolution
4. Realization of a large number of pixels and high speed readout

3. Back-illuminated structure and high resolution

Trench structure to suppress crosstalk

High QE is essential for high efficiency of detecting photons and achieved by back-illuminated structure.

In conventional back-illuminated sensors, crosstalks occur between pixels due to no pixel separation, and resolutions are usually inferior to those of front-illuminated sensors. The ORCA[®]-Quest qCMOS[®]s sensor has back-illuminated structure for achieving high quantum efficiency, and trench structure in one-by-one pixel for reducing crosstalk.

What is a trench structure?

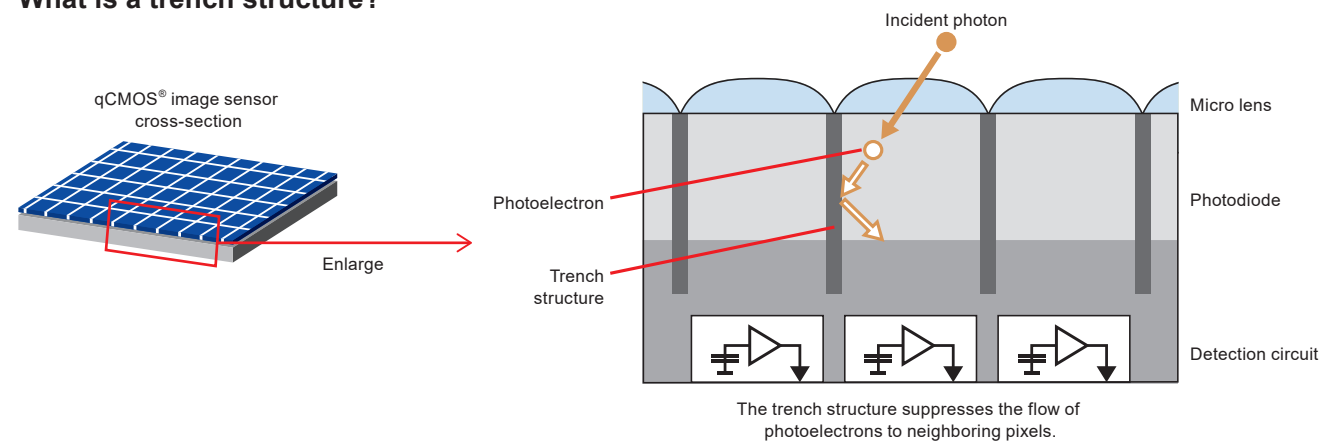

Measurement result of MTF

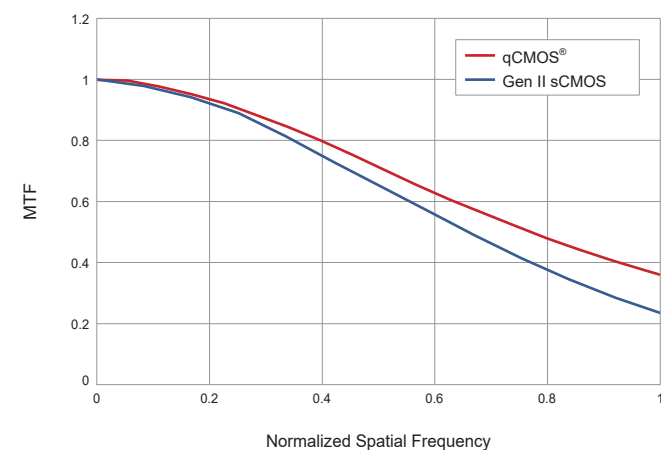

Modulation Transfer Function (MTF) is a type of resolution evaluation. It is the value of how accurately the contrast of an object can be reproduced.

High QE 90 % at 475 nm 33 % at 900 nm

It also has high quantum efficiency in the near-infrared region because of its thicker layer of the charge detection region.

Normally, there is a trade-off between the thickness of the layer of the photon detection region and the resolution, but the trench structure suppresses the degradation of the resolution.

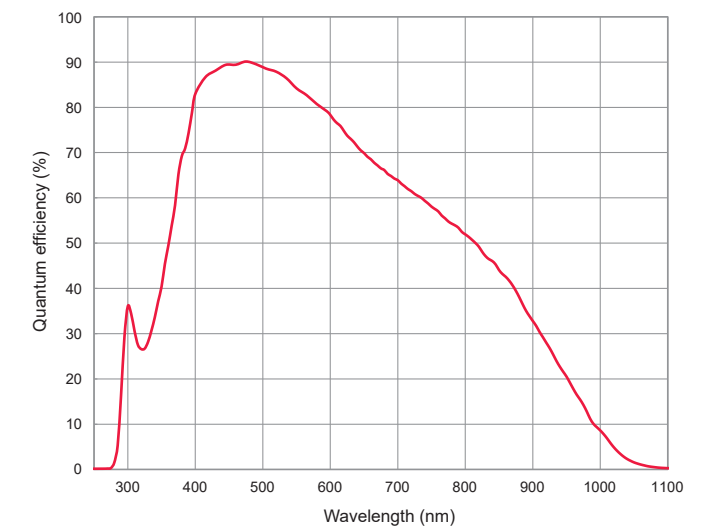

Etaloning-desensitized

Etaloning is a phenomenon that occurs when the incident light interferes with the reflected light from the back surface of the silicon and causes varying sensitivity - dependent both on the spatial and the spectral position. In the case of an EM-CCD camera, it appears as a fringe pattern even with uniform monochrome light input, mostly in the IR.

The qCMOS[®] camera shows minimal etaloning compared to EM-CCD cameras.

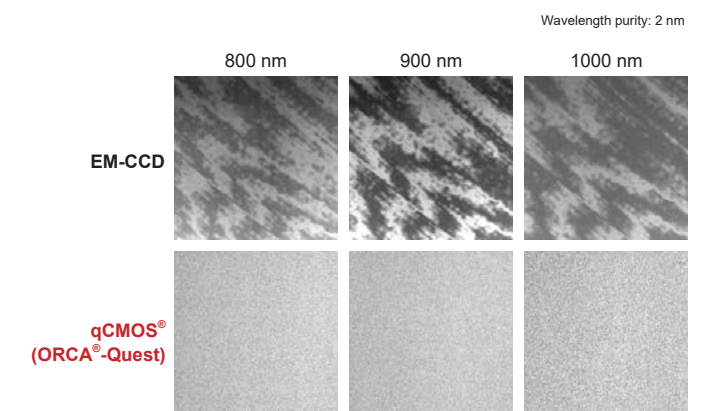

Four key features that enable the ORCA[®]-Quest to achieve ultimate quantitative imaging

1. Extreme low-noise performance
2. Realization of photon number resolving (PNR) output
3. Back-illuminated structure and high resolution
4. Realization of a large number of pixels and high speed readout

4. Realization of a large number of pixels and high speed readout

Realization of PC/PNR with a large number of pixels and high speed at Ultra quiet scan

Photon counting (PC) level images have typically been acquired using electron multiplication camera such as EM-CCD camera with about 0.3 megapixels. However, ORCA[®]-Quest can acquire not only PC level images but also photon number resolving images with 9.4 megapixels.

In addition, it is not fair to compare readout speeds of cameras with different pixel number by frame rate. In such a case the pixel rate (number of pixels × frame rate), which is the number of pixels read out per second, is used.

Until now, the fastest camera capable of SPC readout was the EM-CCD camera with about 27 megapixel/s, but the ORCA[®]-Quest enables photon number resolving imaging at about 47 megapixel/s, nearly twice as fast.

ORCA[®]-Quest (4096 × 2304)

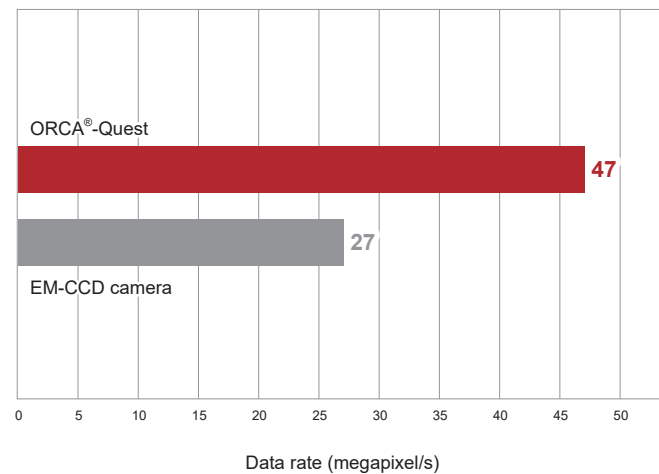

EM-CCD camera (1024 × 1024)

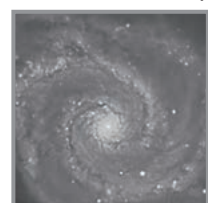

Excellent pixel count and readout speed at Standard scan

ORCA[®]-Quest delivers low noise and it has 4096 (H) × 2304 (V) pixels, about 2.2 times larger than a conventional Gen II sCMOS camera, allowing for the simultaneous capture of a large number of objects. Standard scan delivers less readout noise (0.43 electron), and 2.8 times faster speed than a conventional Gen II sCMOS camera, which enables high-speed low light imaging.

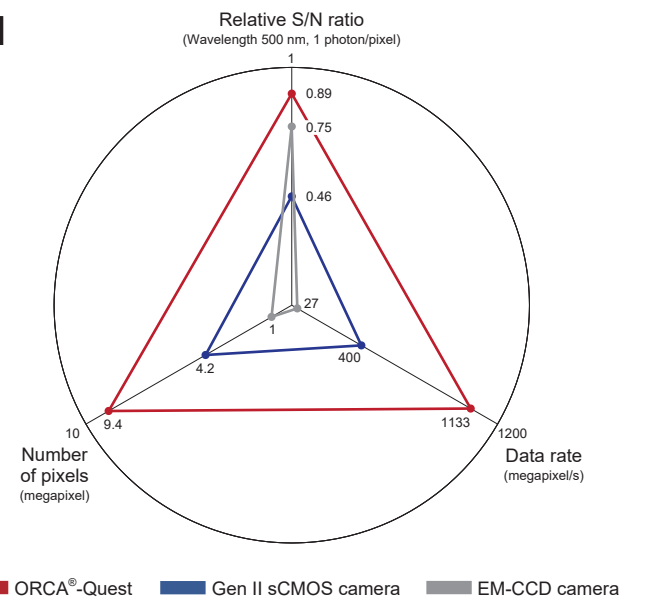

Sensor sizes that can be used with general-purpose optical systems

As the number of pixels increases, the size of the sensor also increases, resulting in cases where the peripheral field of view is missing when using optics such as under a microscope. The ORCA[®]-Quest has 18.841 mm (H) × 10.598 mm (V) by 9.4 megapixels, 4.6 μm px size, that fits in a C-mount of dia.25.4 mm, making it suitable for use with general-purpose optics.

* An F-mount option is also available.

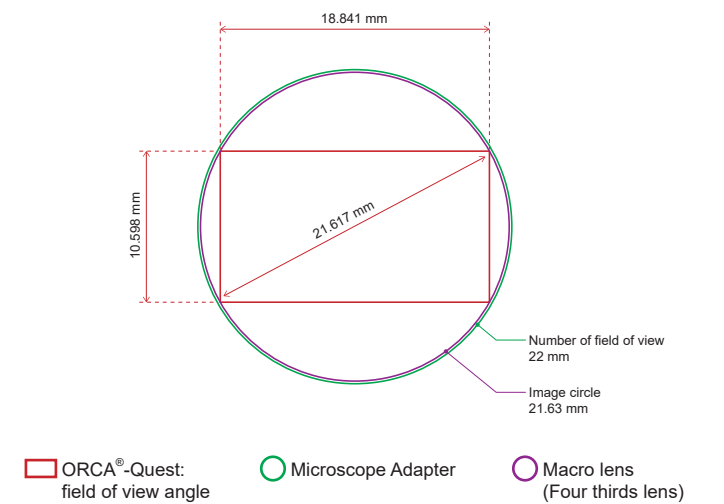

Application and Measurement Examples

Quantum technology

Neutral atom, Ion trap

Neutral atoms and ions can be regarded as so-called qubits because they can take on a superposition state in which even a single atom has multiple properties. This property is being actively investigated to realize quantum computing and quantum simulation. By observing the fluorescence of trapped ions and neutral atoms, the state of the qubit can be determined, and a low-noise camera is used to read out the fluorescence.

Rb atom @780 nm
Number of atoms: 5 × 5 array
Atomic emission: 2000 photons
Background: 5 photons
Magnification: 20 × (NA: 0.4)
Distance between each atom: 5 μm

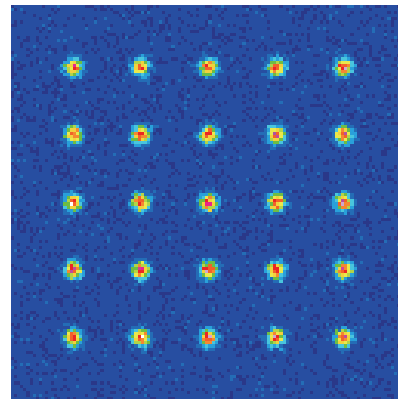

Simulation image

Case studies are now available on our website!

<https://www.hamamatsu.com/all/en/applications/science-and-research/quantum-technology/index.html>



Astronomy

Lucky imaging

When observing stars from the ground, the image of the star can be blurred due to atmospheric turbulence therefore substantially reducing the ability to capture clear images.

However, with short exposures and the right atmospheric conditions, you can sometimes capture clear images. For this reason, lucky imaging is a method of acquiring a large number of images and integrating only the clearest ones while aligning them.

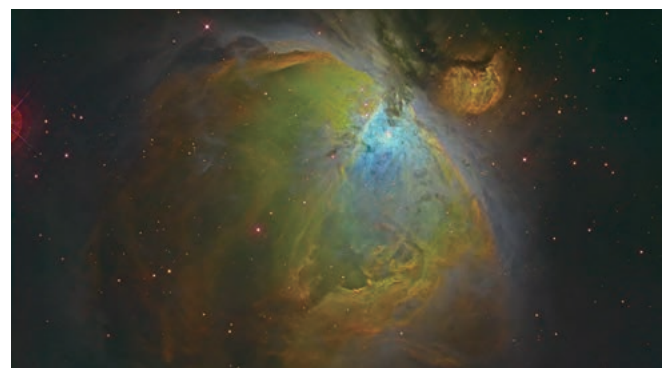

Orion Nebula (Color image with 3 wavelength filters)

Case studies are now available on our website!

<https://www.hamamatsu.com/all/en/applications/science-and-research/astronomy/index.html>



Raman spectroscopy

Raman effect is the scattering of light at a wavelength different from that of the incident light, and Raman spectroscopy is a technique for determining the material properties by measuring this wavelength. Raman spectroscopy enables structural analysis at the molecular level, which provides information on chemical bonding, crystallinity, etc.

Raman spectrum image of acetone

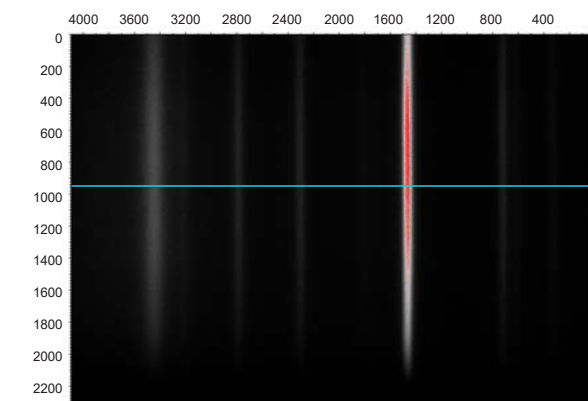

Average Raman spectrum of the straight line (10 pixels vertically)

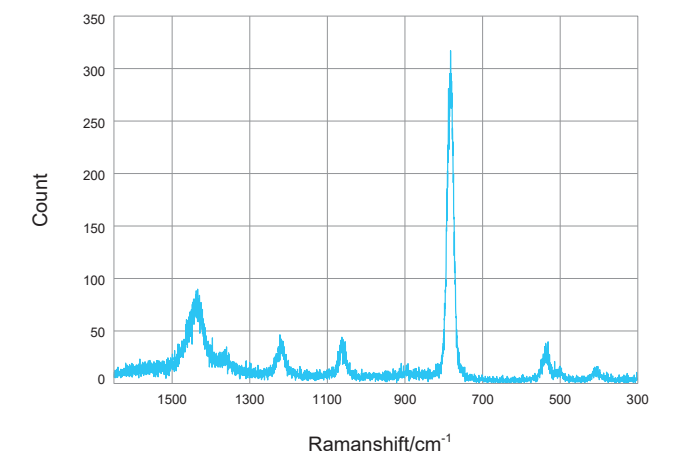

Delayed fluorescence in plants

Plants release a very small portion of the light energy they absorb for photosynthesis as light over a period of time. This phenomenon is known as delayed fluorescence.

By detecting this faint light, it is possible to observe the effects of chemicals, pathogens, the environment, and other stressors on plants.



Delayed fluorescence of ornamental plants
(exposure for 10 seconds after 10 seconds of excitation light quenching)

Specification

Product number	C15550-20UP	
Imaging device	qCMOS [®] image sensor	
Effective number of pixels	4096 (H) × 2304 (V)	
Pixel size	4.6 μm (H) × 4.6 μm (V)	
Effective area	18.841 mm (H) × 10.598 mm (V)	
Quantum efficiency (typ.)	90 % (peak QE)	
Full well capacity (typ.)	7000 electrons	
Readout noise (typ.)	Standard scan	0.43 electrons rms
	Ultra quiet scan	0.27 electrons rms
Dynamic range (typ.) * ¹	25 900: 1	
Dark signal non-uniformity (DSNU) (typ.) * ²	0.06 electrons rms	
Photoresponse non-uniformity (PRNU) (typ.) * ^{2*3}	0.1 % rms	
Linearity error	EMVA 1288 standard (typ.)	0.5 %

Cooling	Sensor temperature	Dark current (typ.)
Forced-air cooled (Ambient temperature: +25 °C)	-20 °C	0.016 electrons/pixels/s
Water cooled (Water temperature: +25 °C)	-20 °C	0.016 electrons/pixels/s
Water cooled (max cooling) (typ.) * ⁴	-35 °C	0.006 electrons/pixels/s

At Normal area readout and Photon number resolving		
Readout mode	Full resolution, Digital binning (2×2, 4×4), Sub-array	
Frame rate at full resolution	Standard scan * ⁵	120 frames/s (CoaXPress), 17.6 frames/s (USB)
	Ultra quiet scan	5 frames/s (CoaXPress, USB)
Exposure time	Standard scan * ⁵	7.2 μs to 1800 s
	Ultra quiet scan	199.9 ms to 1800 s * ⁶
Trigger input	External trigger input mode	Edge / Global reset edge / Level / Global reset level / Sync readout / Start
	Software trigger	Edge / Global reset edge / Start
	Trigger delay function	0 s to 10 s in 1 μs steps
At Lightsheet readout * ⁷		
Readout mode	Full resolution, Sub-array	
Row interval time	7.2 μs to 237.6 μs	
Exposure time	7.2 μs to 271.872 ms	
Trigger input	External trigger input mode	Edge / Start
	Software trigger	Edge / Start
	Trigger delay function	0 s to 10 s in 1 μs steps

Trigger output	Global exposure timing output / Any-row exposure timing output / Trigger ready output / 3 programmable timing outputs / High output / Low output	
Master pulse	Pulse mode	Free running / Start trigger / Burst
	Pulse interval	5 μs to 10 s in 1 μs step
	Burst count	1 to 65 535
Digital output	16 bit / 12 bit / 8 bit	
Image processing function	Defect pixel correction (ON or OFF, hot pixel correction 3 steps)	
Interface	USB 3.1 Gen 1, CoaXPress (Quad CXP-6)	
Trigger input connector	SMA	
Trigger output connector	SMA	
Lens mount	C-mount	
Power supply	AC100 V to AC240 V, 50 Hz/60 Hz	
Power consumption	Approx. 155 VA	
Ambient operating temperature	0 °C to +40 °C	
Ambient operating humidity	30 % to 80 % (With no condensation)	
Ambient storage temperature	-10 °C to +50 °C	
Ambient storage humidity	90 % Max. (With no condensation)	

*1: Calculated from the ratio of the full well capacity and the readout noise in Ultra quiet scan

*2: In Ultra quiet scan

*3: At 3500 electrons, the center 1500 × 1500 area of the image sensor, 1000 times integration

*4: The water temperature is +20 °C and the ambient temperature is +20 °C

*5: Normal area readout mode only

*6: When global reset edge or global reset level trigger is selected, the exposure time is 172.8 μs to 1800 s. When sync readout trigger is selected, 200.2 ms to 1800 s.

*7: Software such as HCLImage is required. For details, please contact your local Hamamatsu representative or distributor.

System Configuration

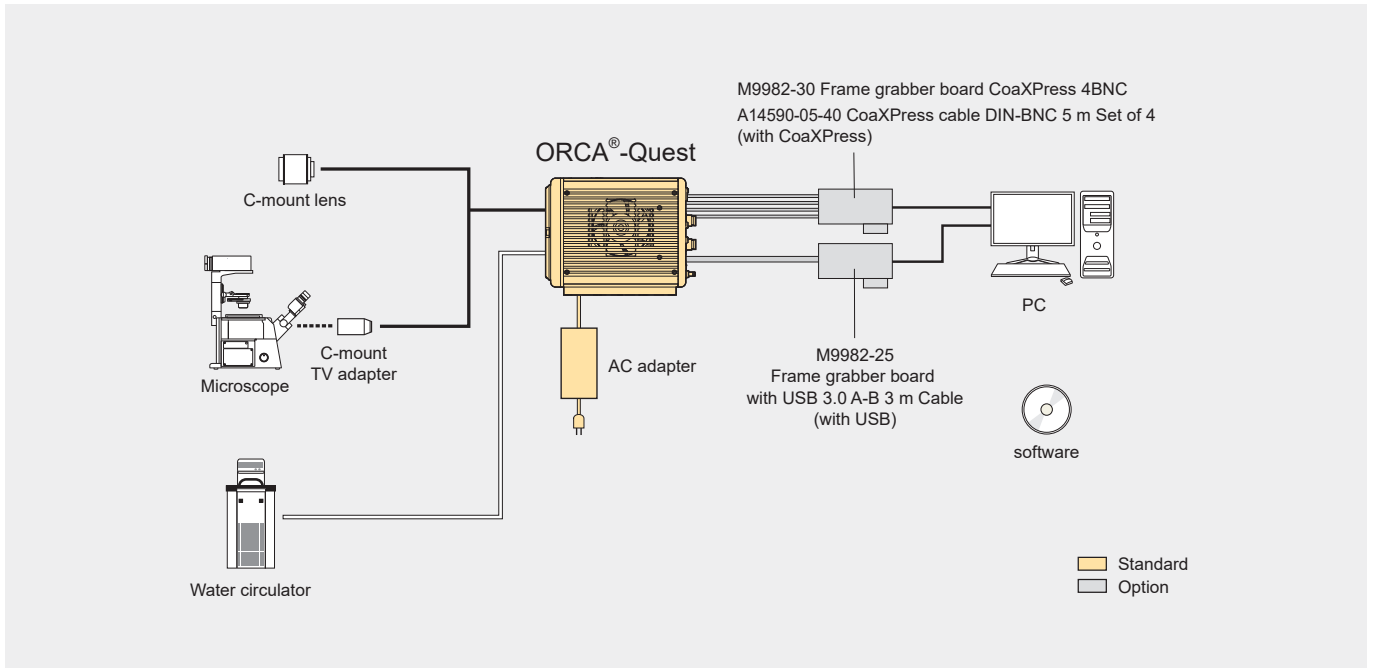

Option

Product number	Product name
M9982-30	Frame grabber board CoaXPress 4BNC
A14590-05-40	CoaXPress cable DIN-BNC 5 m Set of 4
M9982-25	Frame grabber board with USB 3.0 A-B 3 m Cable
A12106-05	External trigger cable SMA-BNC 5 m
A12107-05	External trigger cable SMA-SMA 5 m

Dimensional Outlines (Unit: mm)

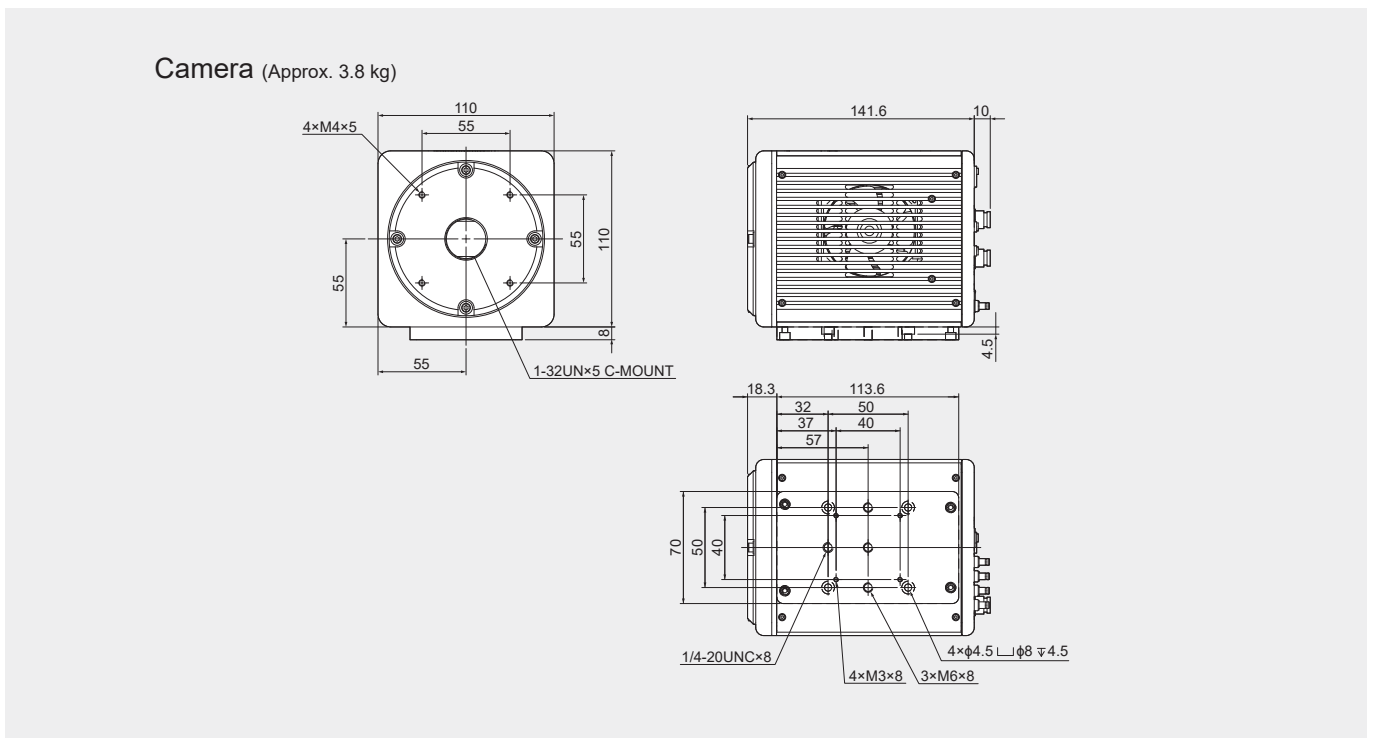

HAMAMATSU

PHOTON IS OUR BUSINESS

ORCA is registered trademark of Hamamatsu Photonics K.K. (China, France, Germany, Japan, U.K., U.S.A.)

qCMOS is registered trademark of Hamamatsu Photonics K.K. (China, EU, Japan, U.K.)

Product and software package names noted in this documentation are trademarks or registered trademarks of their respective manufacturers.

• Subject to local technical requirements and regulations, availability of products included in this promotional material may vary. Please consult your local sales representative.

• Information furnished by HAMAMATSU is believed to be reliable. However, no responsibility is assumed for possible inaccuracies or omissions.

• Specifications and external appearance are subject to change without notice.

© 2021 Hamamatsu Photonics K.K.

HAMAMATSU PHOTONICS K.K. www.hamamatsu.com

Systems Division

812 Joko-cho, Higashi-ku, Hamamatsu City, 431-3196, Japan, Telephone: (81)53-431-0124, Fax: (81)53-433-8031, E-mail: export@sys.hpk.co.jp

U.S.A.: Hamamatsu Corporation: 360 Foothill Road, Bridgewater, NJ 08807, U.S.A., Telephone: (1)908-231-0960, Fax: (1)908-231-1218 E-mail: usa@hamamatsu.com

Germany: Hamamatsu Photonics Deutschland GmbH: Arzbergerstr. 10, 82211 Herrsching am Ammersee, Germany, Telephone: (49)8152-375-0, Fax: (49)8152-265-8 E-mail: info@hamamatsu.de

France: Hamamatsu Photonics France S.A.R.L.: 19, Rue du Saule Trapu, Parc du Moulin de Massy, 91882 Massy Cedex, France, Telephone: (33)1 69 53 71 00, Fax: (33)1 69 53 71 10 E-mail: infos@hamamatsu.fr

United Kingdom: Hamamatsu Photonics UK Limited: 2 Howard Court, 10 Tewin Road, Welwyn Garden City, Hertfordshire AL7 1BW, UK, Telephone: (44)1707-294888, Fax: (44)1707-325777 E-mail: info@hamamatsu.co.uk

North Europe: Hamamatsu Photonics Norden AB: Torshamnsgatan 35 16440 Kista, Sweden, Telephone: (46)8-509 031 00, Fax: (46)8-509 031 01 E-mail: info@hamamatsu.se

Italy: Hamamatsu Photonics Italia S.r.l.: Strada della Moia, 1 int. 6, 20044 Arese (Milano), Italy, Telephone: (39)02-93 58 17 33, Fax: (39)02-93 58 17 41 E-mail: info@hamamatsu.it

China: Hamamatsu Photonics (China) Co., Ltd.: 1201 Tower B, Jiaming Center, 27 Dongsanhuan Beilu, Chaoyang District, 100020 Beijing, P.R. China, Telephone: (86)10-6586-6006, Fax: (86)10-6586-2866 E-mail: hpc@hamamatsu.com.cn

Taiwan: Hamamatsu Photonics Taiwan Co., Ltd.: 8F-3, No.158, Section 2, Gongdao 5th Road, East District, Hsinchu, 300, Taiwan R.O.C. Telephone: (886)3-659-0080, Fax: (886)3-659-0081 E-mail: info@hamamatsu.com.tw

Cat. No. SCAS0151E03
SEP/2021 HPK
Created in Japan