

CUTSHEET

Front View

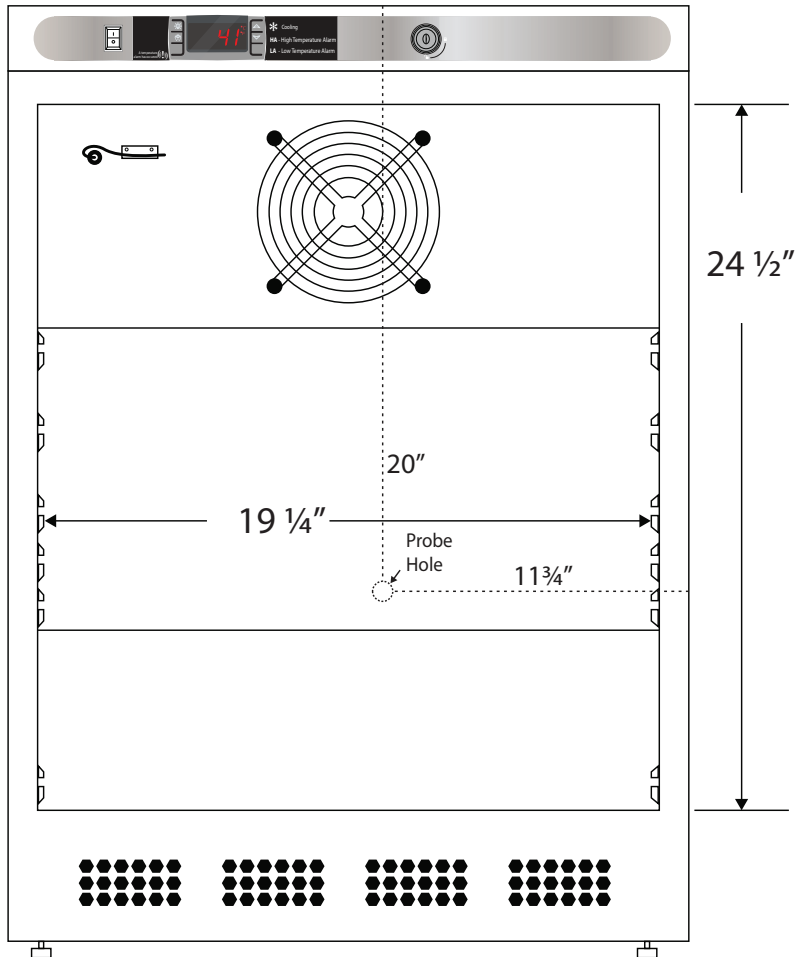

Side View

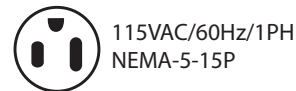
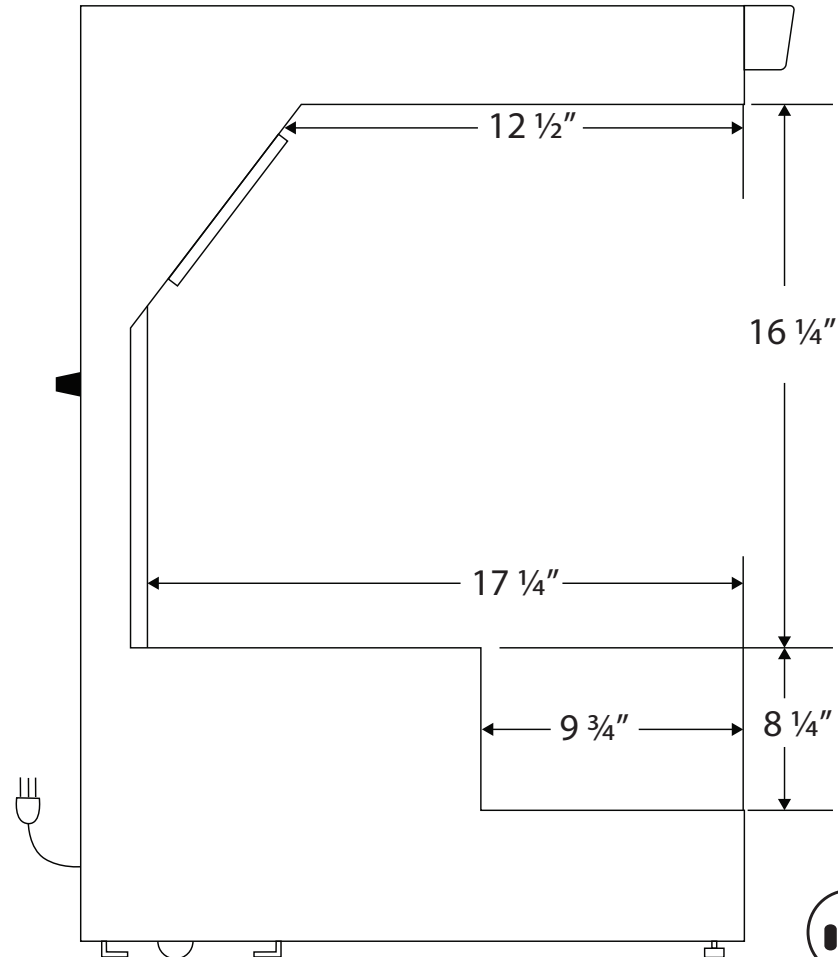

Cu. Ft	Defrost	Door	Int Door	Shelves	Interior Dim.			Refrigerant	H.P.	Amps	Weight
					W"	D"	H"				
4.6	Cycle	1 Solid LH (Reversible)	0	2 Adj/1 Fixed	19 1/4	17 1/4	24 1/2	R600a	1/8	1.74	97 lbs.

Note: Interior dimensions are estimates and subject to change without notice