

Digital Camera C11440-42U / C11440-42U01 Instruction manual

Thank you for your purchase

 CAUTION	<ul style="list-style-type: none">• Follow the safety precautions in Chapter 1 in order to avoid personal injury and damage to property when using this camera. Be sure to read this Instruction manual beforehand in order to use the digital camera correctly. The manual describes the correct method of handling the camera and provides cautions in order to avoid accidents.• After reading, keep the manual where it can be referred to at any time.
--	--



Ver. 1.1
February 2014

HAMAMATSU PHOTONICS K.K.

1. SAFETY PRECAUTIONS







1-1 INDICATION OF THE SYMBOLS

The following symbols can be found on this camera:

	Direct current
	Alternating current

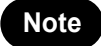
1-2 CLASSIFICATION OF WARNING

We have classified the warnings symbols that appear in this instruction manual and on the camera as follows for your convenience. Make sure that you fully understand them and obey the instructions they contain.

 WARNING	Improper handling of the camera without observing these warnings could lead to serious injury to the user and even death.
 CAUTION	Improper handling of the camera without observing these cautions could lead to personal injury to the user or damage to property.
 Note	This symbol indicates a note to help you get the best performance from the camera. Read the contents of the note carefully to ensure correct and safe use. Failure to observe one of these notes might impair the performance of the camera.
	This symbol indicates a cautionary item that should be obeyed when handling the camera. Read the contents carefully to ensure correct and safe use.
	This symbol indicates an action that is forbidden. Read the contents carefully and be sure to obey them.
	This symbol indicates a compulsory action or instruction. Read the contents carefully and be sure to obey them.

 **WARNING**



Power supply

Use the camera with the voltage indicated on the rating sticker. Using a different voltage can damage the camera and lead to fire or electric shock.



Cables

Be careful not to place heavy objects on cables or bend it excessively. Doing so can damage the cable and lead to fire or electric shock.



Power supply cord

Use the accessory of the AC adaptor when this camera is used.



Do not touch the plug with wet hand. Doing so can lead to electric shock.



Do not attempt to dismantle or modify the camera

Doing so can also lead to damage and even injury, as some internal components become very hot. Only touch parts as indicated in this manual.



Do not insert a foreign substance into the camera

Do not allow foreign objects such as combustible substances, metal objects or water to get inside the camera. They can damage the camera and lead to fire or electric shock.



If an abnormality occurs

Such as the image suddenly disappearing or a strange noise, smell or see smoke coming from the camera, stop the power supply immediately and contact Hamamatsu subsidiary or local distributor. Never attempt to repair the camera yourself.

 **CAUTION**



AC adaptor

When unplugging the AC adaptor, always pull by the plug, not the cord. Doing so can lead to fire or electric shock.



Remove the AC adaptor from the outlet when not using the camera for long periods of time. Doing so can damage the cable and lead to fire or electric shock.



Connecting and disconnecting cables

Always turn off the power supply of the peripheral device before connecting and disconnecting cables.



Fixed the camera

When fitting the camera to a tripod or other fixture, use the optional base plate. Be careful that the fitting screw does not enter more than 8 mm from the surface of the base plate. Screwing it in excessively can impair normal operation.



Lenses (C11440-42U)

Be careful not to screw the lens more than 7 mm onto the C-mount of the camera. Doing so can scratch the protective glass. (Some wide-angle lenses in particular can have a thread of 7 mm or more.)



Shipping precautions

When transporting the camera by truck, ship, airplane, etc., wrap it securely in packaging material or something similar.



Strong impact

Do not subject the camera to strong shocks by dropping it, for example. Doing so can damage the camera.



Operating environment

This system is designed and tested for use in an industrial environment. If this system is used in residential areas, EMI (electro-magnetic interference) may occur. This system must not be used in residential areas.



Disposal

When disposing of the camera, take appropriate measures in compliance with applicable regulations regarding waste disposal and correctly dispose of it yourself, or entrust disposal to a licensed industrial waste disposal company. In any case, be sure to comply with the regulations in your country, state, region or province to ensure the camera is disposed of legally and correctly.

2. CHECK THE CONTENTS OF PACKAGE

When you open the package, check that the following items are included before use. If the contents are incorrect, insufficient or damaged in any way, contact your local dealer without attempting to operate the camera.

Camera (C11440-42U or C11440-42U01)	1
AC adaptor	1
Power supply cord for AC adaptor	1
Lens mount cap (attached to the camera)	1
C11440-42U/C11440-42U01 Before Use (Booklet)	1
C11440-42U/C11440-42U01 Instruction manual (CD-ROM)	1

[Option]

SMA-BNC cable	A12106-05
SMA-SMA cable	A12107-05
USB 3.0 A to Micro B cable	A12046-03
USB 3.0 interface board	M9982-22
Adjuster pole	A11185-01
Base plate	A11186-01

Note

- The cable listed in option is highly recommended for use with the camera. The camera system may not confirm to CE marking regulation if other type of cable is used with.

Note

- If you use the adjuster pole and the base plate, see each installation manual.

3. INSTALLATION

Avoid using or storing this camera in the following places



- When the ambient temperature for using this system might fall below 0 °C or rise above + 40 °C
- When the ambient temperature for storing this system might fall below - 10 °C or rise above + 50 °C
- Where the temperature varies extremely
- In direct sunlight or near a heater
- Where the humidity is 70 % or more or where there is dripping water
- Close to a strong source of magnetism or radio waves
- Where there is vibration
- Where it might come into contact with corrosive gases (such as chlorine or fluorine)
- Where there is a lot of dust

How to place the camera (when the camera is placed on a table)



Do not place the camera the rear panel of the camera, which connectors are located, to be at the bottom. (Do not block ventilation openings.)

Do not block ventilation openings



To prevent overheating in the camera's interior, do not wrap the camera in cloth or other material, or in any way allow the camera's ventilation ports to become blocked. If the camera is being operated in an enclosed environment, ensure clearance of at least 2 cm from both the intake and exhaust vents when setting up.

Contents

1. SAFETY PRECAUTIONS	1
1-1 INDICATION OF THE SYMBOLS	1
1-2 CLASSIFICATION OF WARNING	1
2. CHECK THE CONTENTS OF PACKAGE	4
3. INSTALLATION	5
4. OVERVIEW	8
5. FEATURES	8
6. NAME AND FUNCTION OF THE PARTS	10
7. CONNECTION	13
7-1 CONNECTING OF CABLES	13
8. OPERATION	14
8-1 PRECAUTIONS.....	14
8-2 PREPARATION FOR IMAGING.....	14
8-3 IMAGING	14
8-4 END OF IMAGING.....	14
9. DESCRIPTION OF VARIOUS FUNCTIONS	15
9-1 THEORY OF CMOS IMAGE SENSOR	15
9-2 READOUT METHOD (SCAN MODE)	17
9-3 CAMERA OPERATION MODES.....	18
9-4 FRAME RATE CALCULATION.....	19
9-5 CONFIGURING EXPOSURE TIME	22
9-6 TIMING CHART OF CAMERA OPERATION MODES.....	23
9-6-1 FREE RUNNING MODE.....	23
9-6-2 EXTERNAL TRIGGER MODE.....	25
9-6-3 TRIGGER OUTPUT	30
9-6-4 GLOBAL RESET.....	33
9-7 REAL-TIME CORRECTION FUNCTIONS	34
10. PRECAUTION WHEN USING FL-400	35
11. MAINTENANCE	36
11-1 CARE.....	36
12. TROUBLESHOOTING CHECKLIST	37
12-1 IMAGE IS NOT TRANSFERRED	37
12-2 ALTHOUGH IMAGES ARE TRANSFFERED	37
13. SPECIFICATIONS	38
13-1 CAMERA SPECIFICATIONS	38
13-2 SPECTRAL RESPONSE CHARACTERISTICS	40
14. DIMENSIONAL OUTLINES	41
14-1 C11440-42U for C-mount.....	41

14-2 C11440-42U01 for F-mount	42
15. WARRANTY	43
REPAIRS	43
16. CONTACT INFORMATION	44

4. OVERVIEW

C11440-42U/C11440-42U01 is equipped with the new scientific image sensor “FL-400”, an advanced CMOS device that realizes the multiple benefits of high resolution, high readout speed, and low noise all at once.

The camera provides 4.0 megapixels resolution at 30 frame/s (and up to 25 000 frame/s by sub-array readout) while achieving 0.9 electrons (median) 1.5 electrons (r.m.s) readout noise performance. Moreover, the camera delivers high sensitivity through its on-chip micro lens, 33 000:1 high dynamic range that make the camera suitable for almost any scientific application from bright field imaging to low-light fluorescence imaging across a wide spectral range. Various external trigger functions and timing output functions ensure proper timing control with peripheral equipment to cover a wide range of applications.

The camera is the new scientific digital camera for life science microscopy, semiconductor inspection, x-ray scintillator readout or industrial imaging.

5. FEATURES

(1) Readout noise

In the camera, the pixel amplifier is optimized: it has high gain from optimizing the semiconductor process, and the difference among pixel amplifiers are greatly minimized. In addition, there is on-chip CDS (correlated double sampling) circuit, which plays an important role in achieving low noise. Moreover, the sensor features a split readout scheme in which the top and bottom halves of the sensor are readout independently, and the data of each horizontal line is read by 2 lines of column amplifier and A/D in the top and the bottom in parallel and simultaneously. As a result, it achieves very fast readout speed while keeping very good low-noise performance.

The camera has lower readout noise (0.9 electrons (median), 1.5 electrons (r.m.s)) than the conventional cooled CCD camera. Moreover, high-speed readout (30 frame/s with 2048 pixels × 2048 pixels) with very low readout noise, which was impossible, can now be achieved.

(2) Cooling structure

In the camera, the FL-400 is cooled down by the peltier element to suppress the dark current. The camera has a special chamber structure to avoid the condensation.

(3) Pixel number and pixel size

The FL-400 sensor has 6.5 μm x 6.5 μm pixel sizes that is equivalent to conventional CCD image sensor (2/3 inch, 1.3 megapixels). Also, the camera can observe a wider field of view because the pixel number is about 3 times that of the conventional CCD image sensor (2/3 inch, 1.3 megapixels)

(4) Readout method

The camera has a variety of readout modes. In addition to full resolution readout mode, sub-array readout and binning readout are supported.

(5) Frame rate

The FL-400 realizes both low noise (0.9 electrons (median) 1.5 electrons (r.m.s)) and high speed readout (30 frame/s with 2048 pixels x 2048 pixels) simultaneously, by a split readout scheme in which the top and the bottom halves of the sensor are readout independently, and the data of each horizontal line is read by 2 lines of column amplifier and A/D in the top and the bottom in parallel and simultaneously.

(6) Real-time correction functions

When using the camera, there is a case that shading caused by uneven illumination or optics is not negligible in the image. Also, there are a few pixels in FL-400 that have slightly higher readout noise performance compared to surrounding pixels. For those cases, the camera has real-time offset level, shading and defective pixel correction features to further improve image quality. The correction is performed in real-time without sacrificing the readout speed at all.

(7) Interface

This camera has USB 3.0 interface.

USB 3.0 interface is able to transfer 4 megapixels image with 30 frame/s. It is versatile interface. It transfers image with moderate transfer speed.

(8) Camera operation modes

The camera has three operation modes: 1) the free running mode, in which the exposure and readout timing are controlled by the internal microprocessor, and 2) the external trigger mode, in which the exposure and readout timing are decided by an external trigger. 3) the start trigger mode is used to start operating the camera by a trigger input for a continuous imaging.

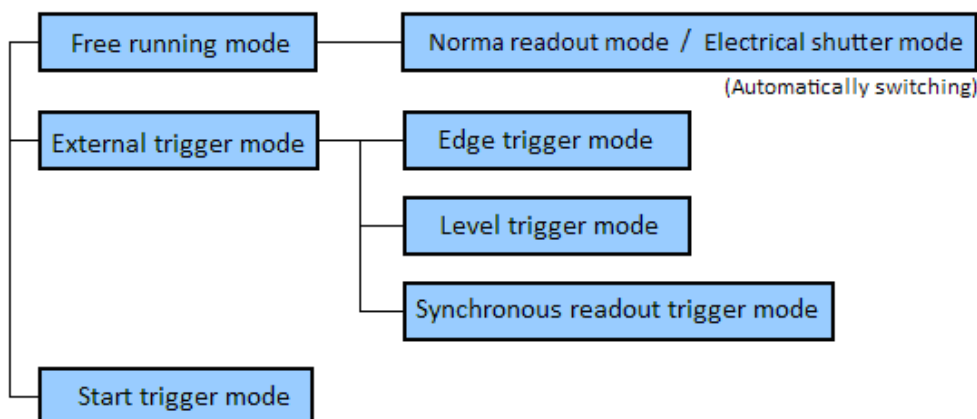

6. NAME AND FUNCTION OF THE PARTS

(1) C11440-42U for C-mount

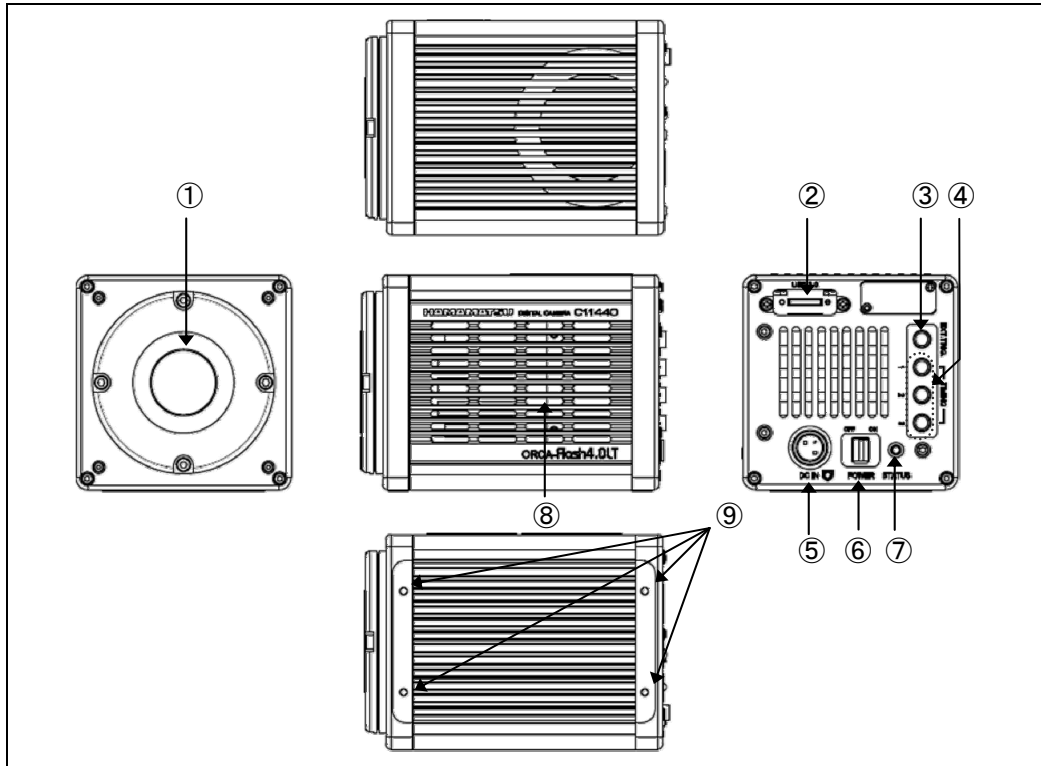

(2) C11440-42U01 for F-mount

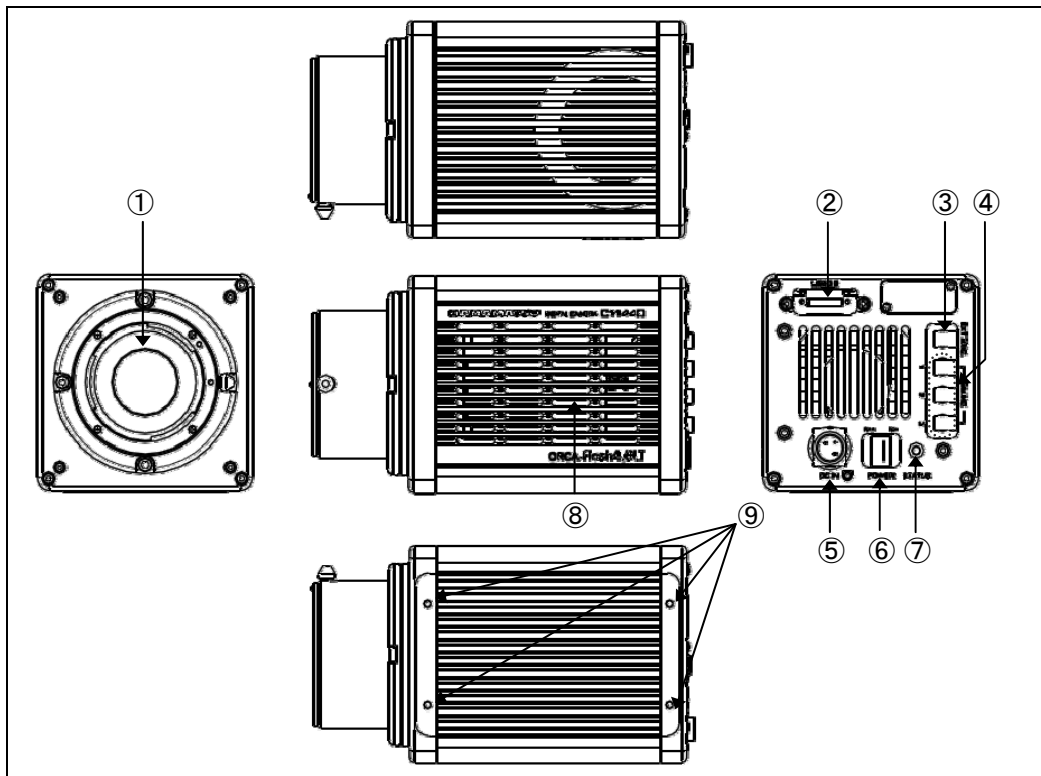

**CAUTION**

- Do not place the rear panel of the camera, which connectors are located, to be at the bottom (Do not block ventilation openings.).

① Lens mount

C11440-42U can be attached to C-mount lens or an optics system.
C11440-42U01 can be attached to F-mount lens or an optics system.

Note

- The depth of the C-mount is 7 mm. Screwing in the mount too far can scratch the glass surface.

② USB 3.0 interface connector [USB 3.0]

This is connected to the USB 3.0 interface connector on the computer.

③ Trigger input connector [EXT.TRIG]

This is used when the camera is being operated using external synchronization.

Input is 3.3 V LVCMOS level, and input impedance is 10 k Ω .

When an external trigger is input, the trigger is activated at the falling or rising edge of the signal. (You can choose external trigger polarity between Negative and Positive.)

④ Timing out connector 1,2,3 [TIMING 1,2,3]

This is used when peripheral device(s) require synchronization with the camera.

Output is 3.3 V LVCMOS level, and it is output through BUS TRANSCEIVER IC SN74AVC8T245.

Output impedance is 33 Ω .

Note

- Determine termination according to cable length and so on.

⑤ DC power input connector [DC IN]

This is the power supply terminal. Use the accessory AC adaptor.

⑥ Power switch [POWER]

The power is turned on/off.

When the power switch is set to "ON", the camera turns on and starts initialization and the lamp blinks in green.

When the initialization is completed, the lamp color stays in green.

When the camera transfers data and the lamp color is orange.

When the power switch is set to "OFF", the camera returns to the power off state and the lamp turns off.

⑦ STATUS lamp [STATUS]

The LED indicates status of camera.

Lighting color	Status of power distribution
Turn off (no color)	Power off
Green (Blinking)	Initialization
Green (lighting)	Power on
Orange (lighting)	Data transfer
Red (lighting)	Heat up

**CAUTION**

- When the camera heats up, stop operation and unplug the AC adaptor immediately.

⑧ **Air outlet**

This is the outlet for the heat ventilation.



- To prevent overheating inside the camera, do not wrap the camera in cloth or other material, or block the camera's ventilation.



- If the camera is being operated in an enclosed environment, ensure to keep clearance at least 2 cm from both intake and exhaust vents when setting up.

⑨ **Installation holes for Base plate**

These are the holes to install the base plate.



- If you use the adjuster pole and the base plate, see each installation manual.

7. CONNECTION

7-1 CONNECTING OF CABLES

Refer to the figure when connecting the various cables.

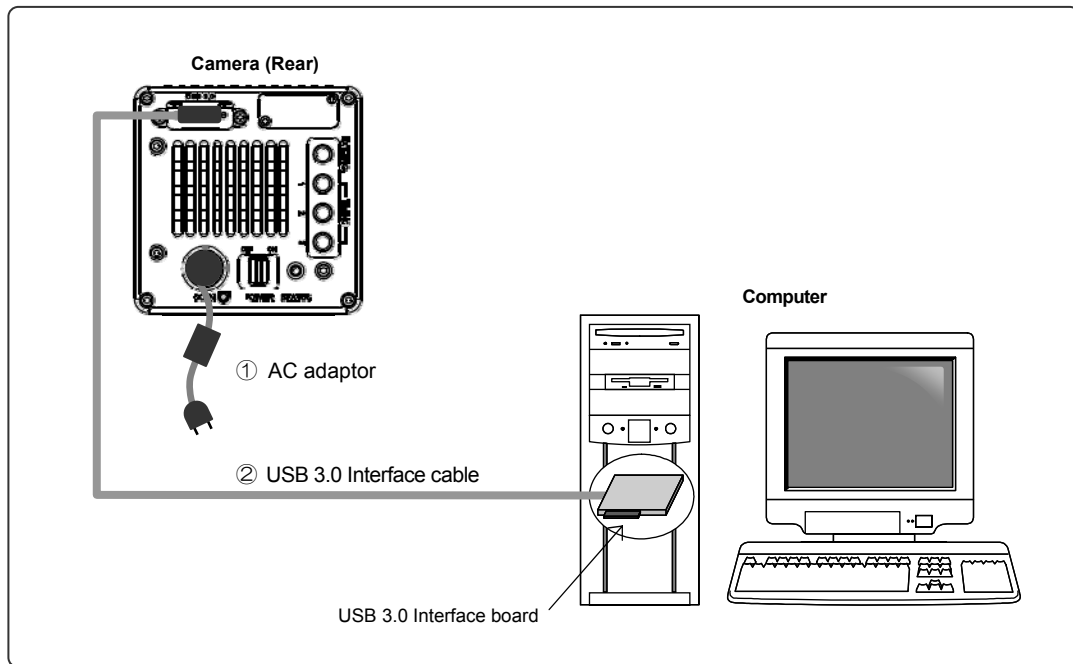

Figure 7-1



- When you connect cables, turn off the power supply of the camera and the peripheral devices.



- If you use the adjuster pole and the base plate, see each installation manual.

CAUTION

- Do not place the rear panel of the camera, which connectors are located, to be at the bottom (Do not block ventilation openings.).

① AC adaptor

This is the cord to supply a power supply. Use the accessory AC adaptor.

② USB 3.0 interface cable (Option)

This is the cable to connect the USB 3.0 interface connector of the camera and the USB 3.0 interface connector on the computer.

Note

- Hamamatsu recommends A12046-03 optional USB 3.0 interface cable for this camera. The camera complies with EMC direction with using A12467-03 Camera Link interface cable. Be careful that the camera with other interface cable may not fulfill the EMC directive requirements.

8. OPERATION

8-1 PRECAUTIONS

Be careful of the following when you operate the camera.

(1) Cooling method

Cooling of this equipment is done using a Peltier element. With a Peltier element, when current is supplied, one surface is cooled, and the other surface is heated. The FL-400 is positioned on the cooling side, and cooling is done by discharging the heat from the heated surface. This cooling method is passive air-cooling.

(2) Ambient temperature

The recommended ambient temperature for camera operation is between 20 °C and 25 °C. Thus, the maximum temperatures to which the FL-400 can be cooled, and the stability of the cooled temperature, are affected by the ambient temperature. The ambient temperature should be maintained at a constant temperature in order for cooling to be effective.

(3) Protection circuit

A double protection circuit protects this camera's thermoelectric cooling device. If the heat dissipater becomes abnormally hot, the protection circuit sets off a buzzer alarm and stopping current supply to Peltier element simultaneously.

When the protection circuit is activated immediately turn off the power switch. Then investigate cause and remove the cause of the overheating and restart the camera.

8-2 PREPARATION FOR IMAGING

Use the following procedure when starting operating of the camera.

- (1) Connect devices as shown in Figure 7-1 before you start operation.
- (2) Turn on the computer's power switch.

The cooling temperature becomes stable about 5 minutes after cooling begins.



- When the cables are connected, confirm the power switch of peripheral device is in the OFF position.

8-3 IMAGING

Start the control and imaging with the application software.

Note

- Please refer to the instruction manual attached to the software for the way of using it and the details.

8-4 END OF IMAGING

Carry out the procedure below when imaging is finished.

- (1) End the imaging or transmission of image data with the application software.
- (2) Turn off the power to the peripheral device.

9. DESCRIPTION OF VARIOUS FUNCTIONS

9-1 THEORY OF CMOS IMAGE SENSOR

The pixel of a CMOS image sensor is composed of the photodiode and the amplifier that converts the charge into voltage. Entered light is converted to charge and converted to voltage in the pixel. The voltage of each pixel is output by switching the switch one by one. (Figure 9-1)

The FL-400 scientific CMOS image sensor used in this camera has an on-chip CDS (correlated double sampling) circuit, which plays an important role in achieving low noise. In addition, the FL-400 realizes both low noise and high speed readout simultaneously, by a split readout scheme in which the top and the bottom halves of the sensor are readout independently, and the data of each horizontal line is read by 2 lines of column amplifier and A/D in the top and the bottom in parallel and simultaneously.

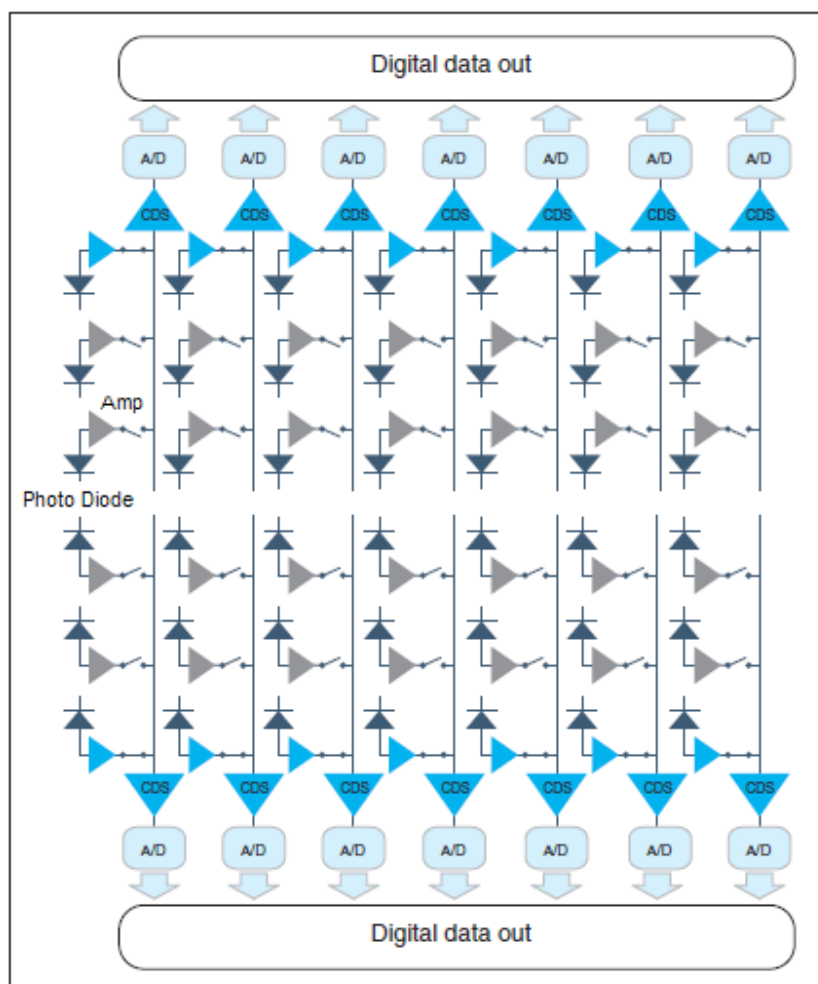

Figure 9-1 Structure of the FL-400

The exposure and the readout method of FL-400 is rolling shutter.
In the rolling shutter, the exposure and readout are done line by line. Therefore, the exposure timing is different on one screen. (Figure 9-2)
But even if the object moves during the exposure, the affect of rolling shutter is very small.

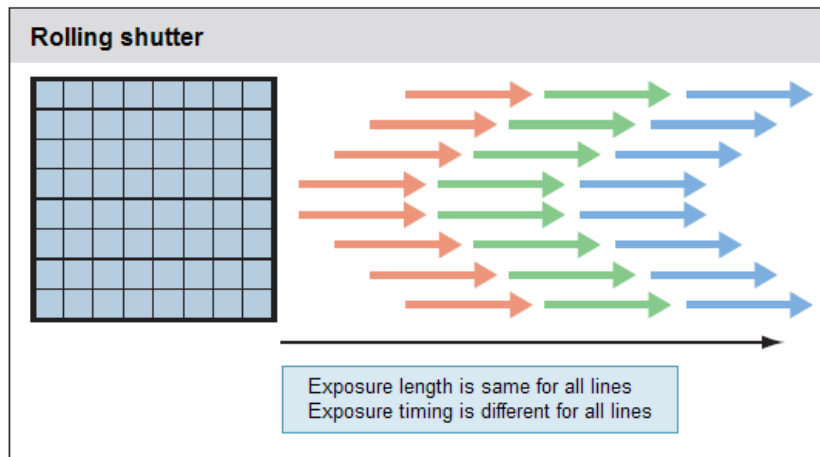

Figure 9-2 Readout timing of Rolling shutter

9-2 READOUT METHOD (SCAN MODE)

The camera has the following scan modes.

(1) Normal readout

Perform charge readout from camera individually for all pixels.

(2) Binning readout

With this camera, 2×2 binning readout and 4×4 binning are available by adding the signal of adjacent pixels in the digital domain, Binning readout is a method for achieving high sensitivity in exchange for losing resolution.

(3) Sub-array readout

Sub-array readout is a procedure only a region of interest is scanned. It is possible to increase the frame rate by reducing the number of vertical lines scanned. When a target area is placed in the center of the screen, sub-array readout can perform the fastest readout. In sub-array readout, binning configuration is enabled.

Size and a position of the readout area can be configured according to the table below.

Binning	Settings			
	Horizontal		Vertical	
	Size	Position	Size	Position
1×1 (Normal readout)	512 pixels	32 pixels	8 lines	4 lines
2×2 binning readout	256 pixels	16 pixels	4 lines	2 lines
4×4 binning readout	128 pixels	8 pixels	2 lines	1 lines

(4) Rapid Rolling Mode

This readout mode is preferred to be used when acquiring images of fast moving samples in order to minimize distortion come from rolling shutter.

Note

- Please refer to 9-4 [FRAME RATE CALCULATION] about the frame rate of each readout mode. However, Rapid Rolling mode is different from other modes.

9-3 CAMERA OPERATION MODES

The camera has the following operation modes.

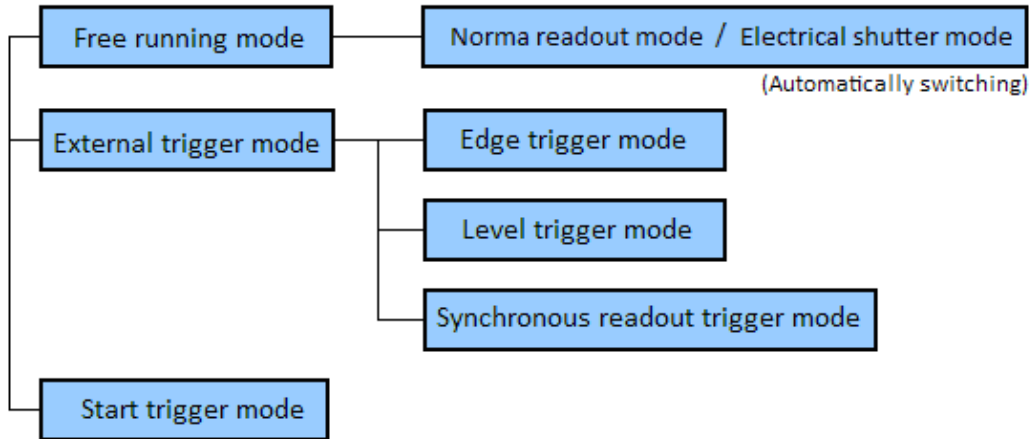

(1) Free running mode

The camera has the free running mode which the exposure and readout timing can be set by software command and controlled by an internal microprocessor. The free running mode has normal readout mode (in which the exposure time is longer than the 1 frame readout time) and electrical shutter mode (in which the exposure time is shorter than the 1 frame readout time). These readout modes are automatically switched depending on the exposure time setting.

(2) External trigger mode

The camera has various external trigger functions to synchronize the camera with the external equipment. In the external trigger mode, the external equipment becomes a master and the camera becomes a slave.

① Edge trigger mode

The edge trigger mode is used so that the exposure starts according to an external signal.

② Level trigger mode

The level trigger mode is used to control both exposure start timing and exposure time length by inputting external trigger pulses.

③ Synchronous readout trigger mode

The synchronous readout trigger mode is used for continuous imaging when it is necessary to control the exposure start timing of each frame from an external source. It is useful for confocal microscopy.

(3) Start trigger mode

The start trigger mode is to start operating the camera by a trigger input for a continuous imaging.

Note

- Please refer to 9-6 [TIMING CHART OF CAMERA OPERATION MODES] about the detail of timing chart of these modes.

9-4 FRAME RATE CALCULATION

The calculation formula of frame rate and the value of frame rate are as below.

■ Calculation formula

- Vn = Number of vertical line
(The center of the set area is the middle of the sensor.)
Exp1 = 3 ms to 10 s
1H = 32.4812×10^{-6}

Free running mode	$1/(Vn/2 \times 1H)$
External trigger mode (Edge/Level)	$1/(Vn/2 \times 1H + Exp1 + 1H \times 9)$
External trigger mode (Synchronous readout)	$1/(Vn/2 \times 1H + 1H \times 17)$



- The Exp1 value has to be input to the calculation formula below in units of seconds.

■ Value of frame rate

Horizontal width × Vertical width		Free running mode	External trigger mode (Edge/Level)	External trigger mode (Synchronous readout)
2048	2048	30	27	29
	1024	60	50	58
	512	120	85	112
	256	240	133	212
	128	481	185	380
	64	962	229	628
	8	7696	290	1466

(frame/s)

The calculation formula of frame rate and the value of frame rate for Rapid Rolling Mode are shown in next page.

■ Calculation formula (Rapid Rolling Mode)

- V_n = Number of vertical line
 (The center of the set area is the middle of the sensor.)
 $Exp1$ = 1 ms to 10 s
 $Exp2$ = 1.05 ms to 10 s
 $1H$ = 10×10^{-6}
 $int()$ = The decimal point is rounded down.



- The $Exp1$ and $Exp2$ values must be input to the calculation formula below in units of seconds.

	Binning	Horizontal width	Vertical width	Calculation formula
Free running mode	1×1	1024 1536 2048	—	$1/(int(V_n/2048/30/1H) \times 1H)$
	1×1	512	—	$1/(V_n/2 \times 1H)$
	2×2 4×4	—	—	
External trigger mode (Edge trigger)	1×1	1024 1536 2048	$112 \leq V_n \leq 2048$	$1/(V_n/2 \times 1H + Exp1 + 1H \times 9)$
	1×1	1024 1536 2048	$8 \leq V_n \leq 104$	$1/(V_n/2 \times 1H + 1H \times 9 + Exp1)$
	1×1	512	—	
	2×2 4×4	—	—	
External trigger mode (Level trigger)	1×1	1024 1536 2048	$112 \leq V_n \leq 2048$	$1/(int(V_n/2048/30/1H) \times 1H)$
	1×1	1024 1536 2048	$8 \leq V_n \leq 104$	$1/(V_n/2 \times 1H + 1H \times 4 + Exp2)$
	1×1	512	—	
	2×2 4×4	—	—	
External trigger mode (Synchronous readout)	1×1	1024 1536 2048	$32 \leq V_n \leq 2048$	$1/(int(V_n/2048/30/1H) \times 1H)$
	1×1	64 1024 1536 2048	$8 \leq V_n \leq 24$	$1/(V_n/2 \times 1H + 1H \times 17)$
	1×1	512	—	
	2×2 4×4	—	—	

Value of frame rate (Rapid Rolling Mode)

	Vertical width \ Horizontal width	1×1 (Normal readout)		(frame/s)
		1024 / 1536 / 2048	512	Binning: 2×2 / 4×4
Free running mode	2048	30	97	97
	1024	60	195	195
	512	120	390	390
	256	240	781	781
	128	480	1562	1562
	64	961	3125	3125
	8	7692	25 000	25 000
External trigger mode (Edge trigger)	2048	30	88	88
	1024	60	160	160
	512	120	271	271
	256	240	416	416
	128	480	568	568
	64	694	694	694
	8	862	862	862
External trigger mode (Level trigger)	2048	30	87	87
	1024	60	159	159
	512	120	270	270
	256	240	413	413
	128	480	561	561
	64	684	684	684
	8	847	847	847
External trigger mode (Synchronous readout)	2048	30	96	96
	1024	60	189	189
	512	120	366	366
	256	240	689	689
	128	480	1234	1234
	64	961	2040	2040
	8	4761	4761	4761

Note

- The calculation formula and the frame rate value of Start trigger mode (External trigger mode) are same as the free running mode. About this mode, refer to 9-6-2-4 [Start trigger mode].

9-5 CONFIGURING EXPOSURE TIME

The exposure time setting can be done by absolute value. The actual exposure time setting is defined by the following formula, and the camera automatically calculates a larger and closest value from the specified exposure time setting.



- The Exp1 values must be input to the calculation formula below in units of seconds.

$$32.4812 \mu\text{s} \times \text{Exp2}$$

Exp1 = 3 ms to 10 s (at sub-array 129.99 μs to 10 s)

Exp2 = $\text{Exp1} \times 10^6 \div 32.4812 \mu\text{s}$ (round up at decimal point)

The actual exposure time setting for Rapid Rolling Mode is defined by the following formula.

$$10 \mu\text{s} \times \text{Exp2}$$

Exp1 = 1 ms to 10 s (at sub-array 40 μs to 10 s)

Exp2 = $\text{Exp1} \times 10^6 \div 10 \mu\text{s}$ (round up at decimal point)

Available setting range of the exposure time is the following.

Free running mode	3 ms to 10 s
	1 ms to 10 s (Rapid Rolling Mode)
Free running mode (at Sub-array)	129.99 μs^* to 10 s
	40 μs^* to 10 s (Rapid Rolling Mode)
External trigger mode	3 ms to 10 s
	1 ms to 10 s (Rapid Rolling Mode)

Note

* 129.99 μs and 40 μs (Rapid Rolling Mode) for the Free running mode (at Sub-array) is the minimum exposure time when sub-array is set to 8 lines vertically symmetric (4 lines in top half and 4 lines in bottom half) with respect to the horizontally center axis. The minimum exposure time vary depend on vertical line number of sub-array setting.

9-6 TIMING CHART OF CAMERA OPERATION MODES

9-6-1 FREE RUNNING MODE

The camera has the free running mode which the exposure and readout timing can be set by software command and controlled by an internal microprocessor. The free running mode has normal readout mode (in which the exposure time is longer than the 1 frame readout time) and electrical shutter mode (in which the exposure time is shorter than the 1 frame readout time). These readout modes are automatically switched depending on the exposure time setting.

Note

- Please contact to Hamamatsu subsidiary or local distributor for the detail of the timing information.

9-6-1-1 Normal readout mode

The normal readout mode is suitable for observation, monitoring, field of view and focus adjustment, and animation because it can operate with full resolution, which is faster than the video rate (30 frame/s).

In addition, the exposure time can be extended to collect more signals and increase the signal-to-noise ratio if the object is dark. In the normal readout mode, the exposure time is the same or longer than the 1 frame readout time. In this mode, the frame rate depends on the exposure time, and it becomes frame rate = 1/exposure time. The maximum exposure time is 10 s.

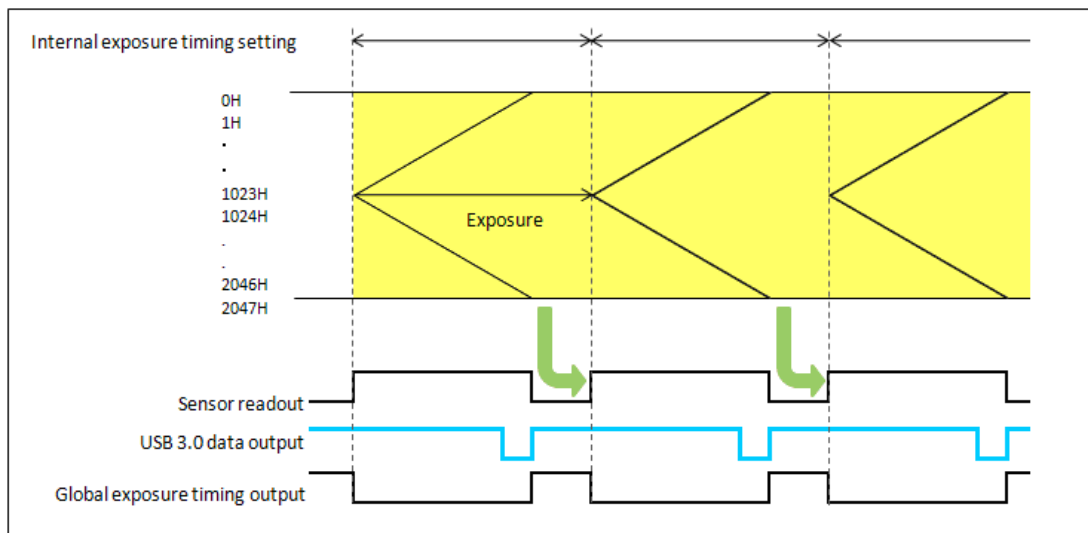

Figure 9-3

9-6-1-2 Electrical shutter mode

The electrical shutter mode is used to get a proper signal level when signal overflow happens due to too much input photons in normal readout mode. In this mode, the fastest frame rate is 30 Hz at full resolution even when the exposure time is short.

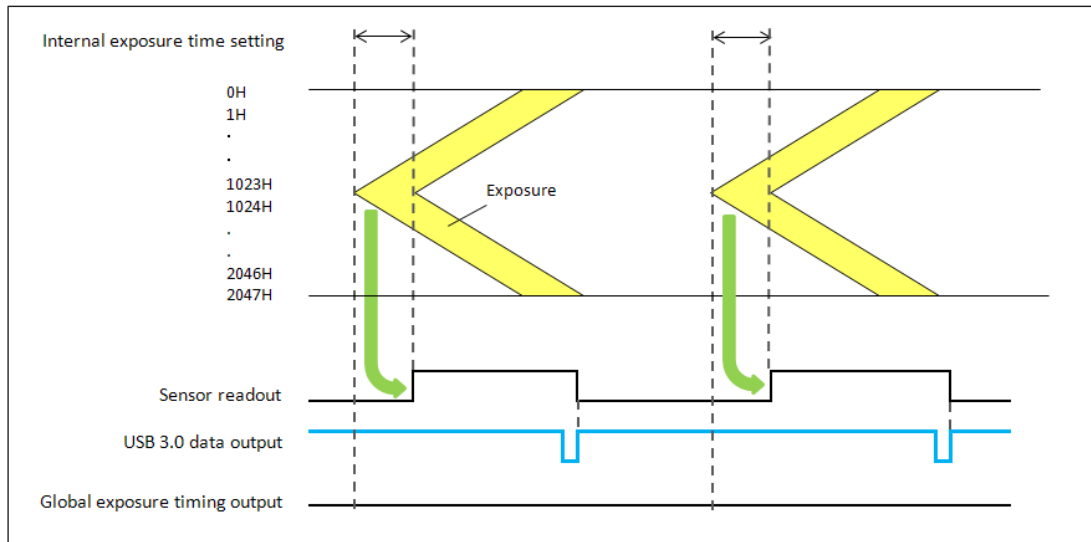

Figure 9-4

9-6-2 EXTERNAL TRIGGER MODE

The camera has various external trigger functions to synchronize the camera with the external equipment. In the external trigger mode, the external equipment becomes a master and the camera becomes a slave.

Note

- Please contact to Hamamatsu subsidiary or local distributor for the detail of the timing information.

9-6-2-1 Edge trigger mode

The edge trigger mode is used so that the exposure starts according to an external signal. Exposure time is set by software command. In this mode, the exposure of the first line begins on the edge (rising/falling) timing of the input trigger signal into the camera. (1023H and 1024H in the following figure) The exposure of the second line is begun after the readout time of one line passes (1022H and 1025H in the following figure), and the exposure is begun one by one for each line.

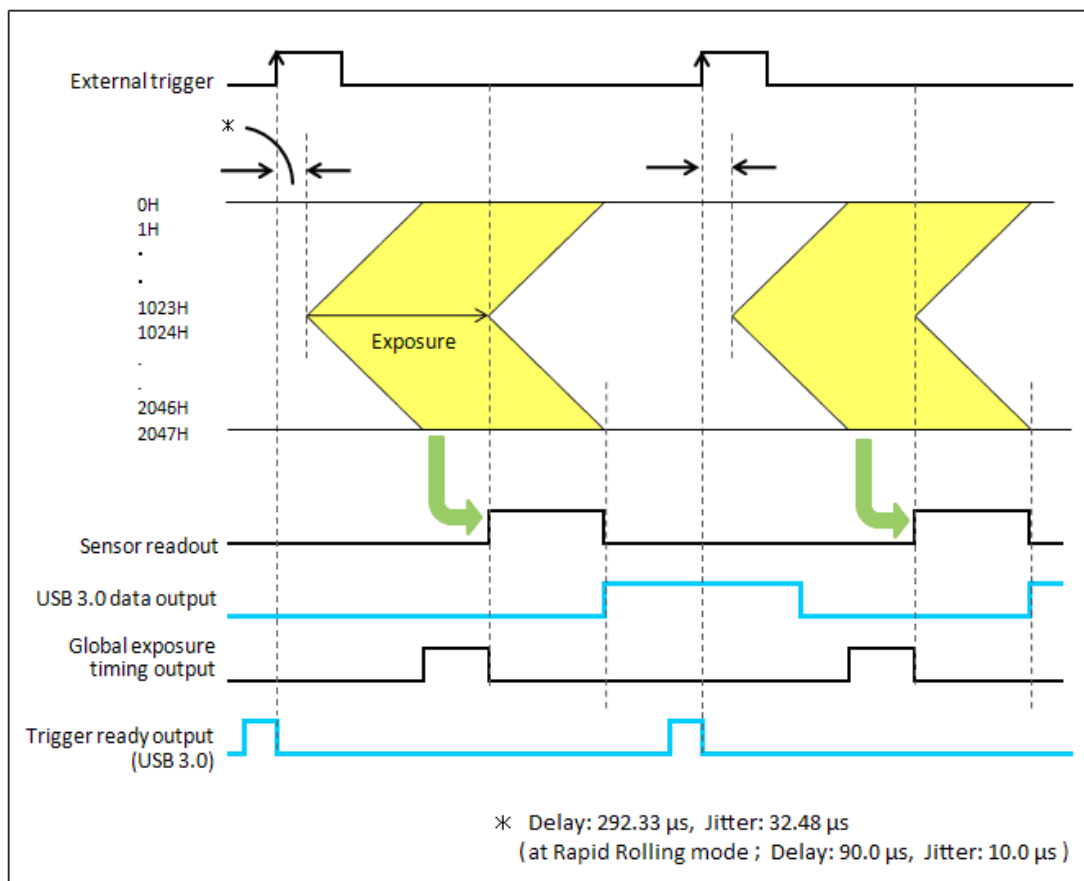

Figure 9-5 (Ex. rising edge)

9-6-2-2 Level trigger mode

The level trigger mode is used to control both exposure start timing and exposure time length by inputting external trigger pulses. In the mode, the camera starts exposure at the start of high or low period of the input trigger pulse and stops exposure at the end of high or low period of the input trigger pulse. The example below is for the trigger level High. The exposure of the first line begins when the trigger signal becomes High, and the exposure of the second line begins after the readout time of line one passes. Each exposure begins one by one for each line. The exposure of the first line is finished when the trigger signal becomes low, and signal readout is begun. The exposure time of each line is defined by the time that the input trigger is high. The minimum trigger pulse width is 1 ms + 50 μ s.

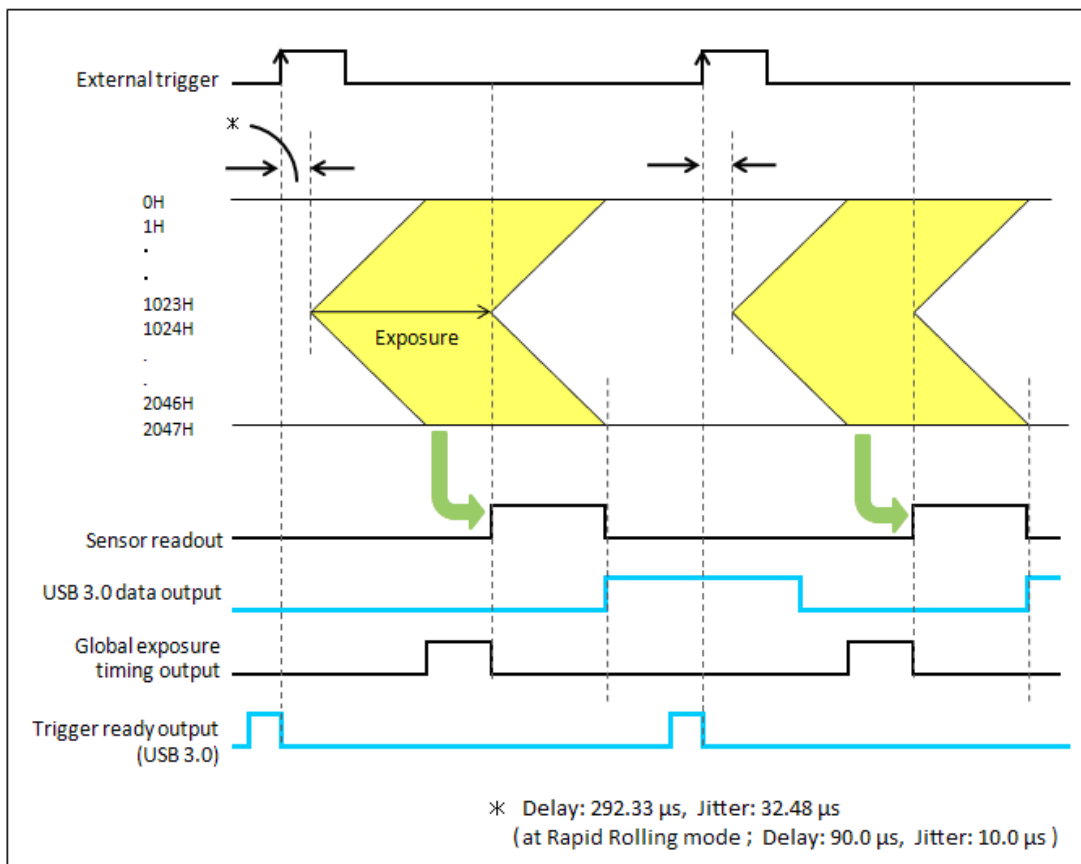

Figure 9-6 (Ex. rising edge)

9-6-2-3 Synchronous readout trigger mode

The synchronous readout trigger mode is used for continuous imaging when it is necessary to control the exposure start timing of each frame from an external source. It is useful for confocal microscopy. For example, when the camera is used with a spinning disk confocal microscope and the camera exposure time is synchronized to the spinning disk's rotation speed, it is possible to eliminate uneven illumination (called banding noise) caused by variation of the spinning disk rotation speed. Also, it is useful for securing as long exposure time as possible while controlling the exposure start timings by external trigger signals.

(1) Normal operation (when the pulse count is set as 1.)

The synchronous readout trigger mode is used for continuous imaging when it is necessary to control the exposure start timing of each frame from an outside source and also when it is necessary to secure as long exposure time as possible. In the synchronous readout trigger mode, the camera ends each exposure, starts the readout and also, at the same time, starts the next exposure at the edge of the input trigger signal (rising / falling edge). That is, the interval between the same edges of the input trigger becomes the exposure time.

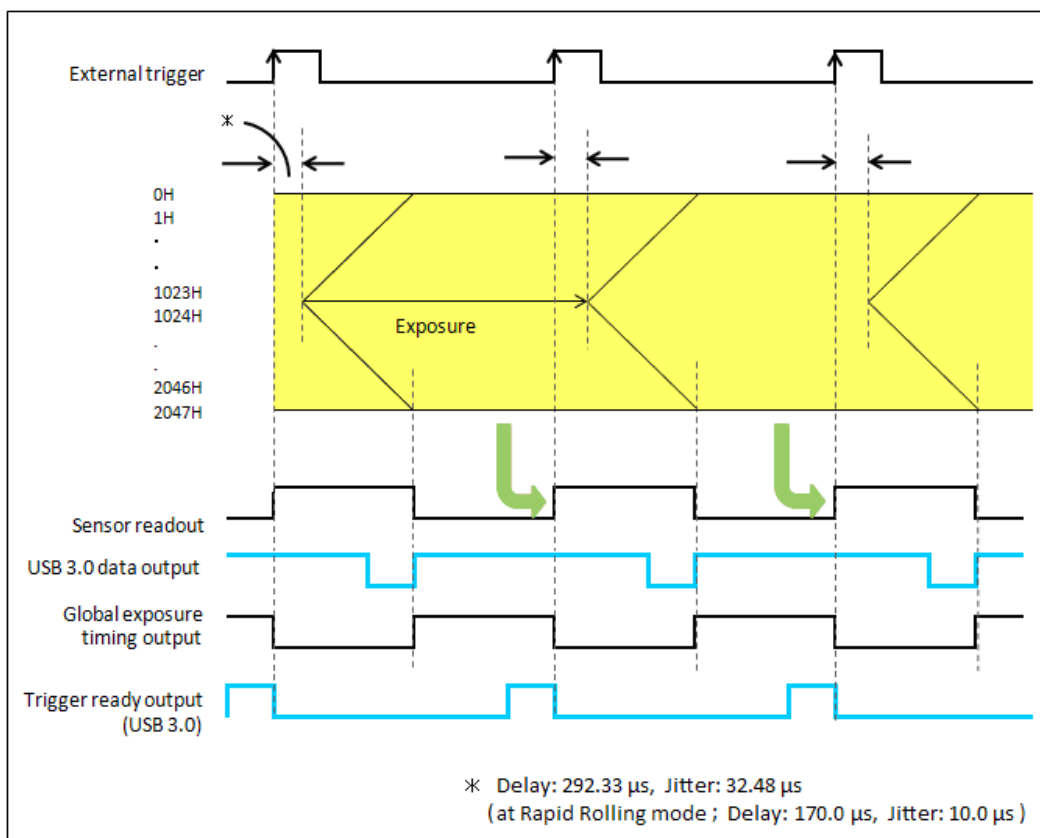

Figure 9-7 (Ex. rising edge)

(2) Pulse count

Also in the synchronous readout trigger mode, synchronous readout can be controlled by specifying, set by command, the number of timing pulses to determine the exposure time. The following figure shows the exposure timing when the pulse count is set as 3.

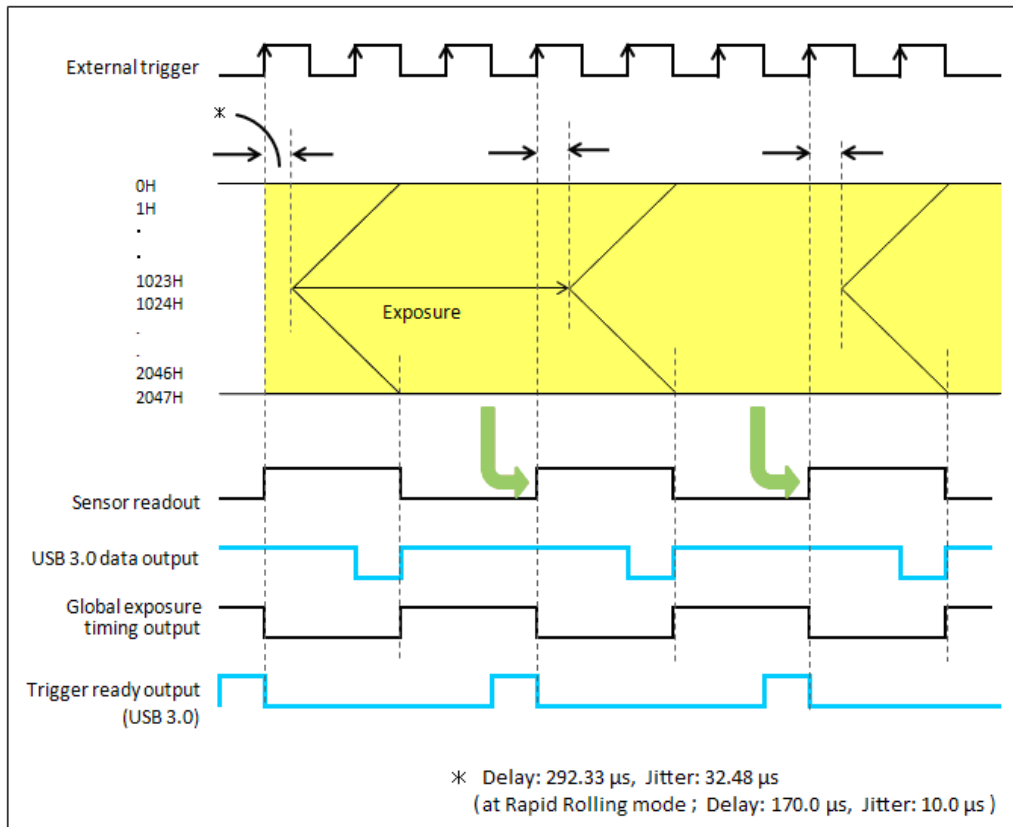

Figure 9-8 (Pulse count)

9-6-2-4 Start trigger mode

The start trigger mode is to start operating the camera by a trigger input for a continuous imaging. It is useful to secure the frame rate as fast as possible when continuous image acquisition and not to sacrifice the exposure time. For example, when it is necessary to measure the phenomenon after stimulation, it is possible to start continuous image acquisition at the stimulation timing.

The start trigger mode is to start operating the camera by a trigger input for continuous imaging, and it works at the highest frame rate because it is operated in internal trigger mode. In the start trigger mode, the camera starts exposure and switches to internal trigger mode by the edge of an external trigger signal (rising / falling edge).

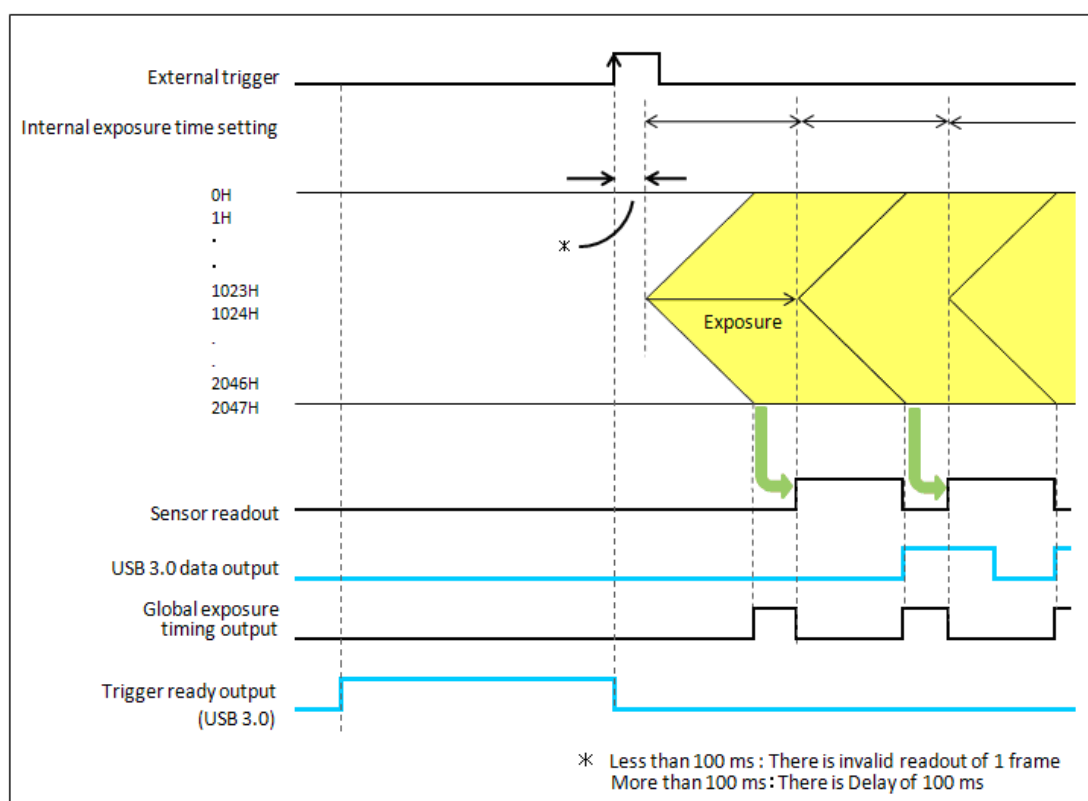

Figure 9-9 (Ex. rising edge)

9-6-2-5 External trigger delay function

In most cases when a delay is needed between the laser pulse emission and the exposure start is needed, a delay unit is set between the laser and camera to control trigger timing. In each external trigger mode of the camera, the delay can be set to the trigger signal input to the camera by command. With this setting, a range of trigger can be arranged without a delay unit. The range for delay time is 0 μ s to 10 s (10 μ s steps).

9-6-3 TRIGGER OUTPUT

The camera provides a range of trigger output signals to synchronize with an external instrument and the camera becomes the master and the external instrument becomes the slave. There are three different trigger output functions as follows. Also, it can output continuous High output (High output fixed) or continuous Low output (Low output fixed).

These three different trigger output functions can be selected by software command, and they are output from Timing out connector.

Note

- Please refer to Figure 9-3 to Figure 9-9 about details of each trigger output functions.

9-6-3-1 Global exposure timing output

It shows the global exposure timing where all lines expose at the same time. There is a case that one event is divided into two frames because the timing of the exposure in each line is different for the rolling shutter. However, by using the Global exposure timing output the global exposure becomes possible for the phenomenon that happens for this period. Global exposure timing output shows the period where all lines expose at the same time.

Note

- There is no output signal when the exposure time is less than the frame rate.

9-6-3-2 Programmable timing output

By using the programmable timing output, synchronizing external devices is simple. A system that needs simple timing signal does not require a delay unit or pulse generator. It is possible to program and output a pulse that has an optional pulse width and an optional delay time to the end of readout timing or Vsync. The setting range for delay time is 0 μ s to 10 s, and the setting range for pulse width is 10 μ s to 10 s.

The relation between the parameter which can be set with each reference signal, and an output signal becomes below.

Reference signal	Output signal
Read End	Camera outputs a pulse after certain delay, from the end of sensor readout. Also the pulse width can be set.
Vsync	Camera outputs a pulse after certain delay, from the beginning of readout. Also the pulse width can be set.

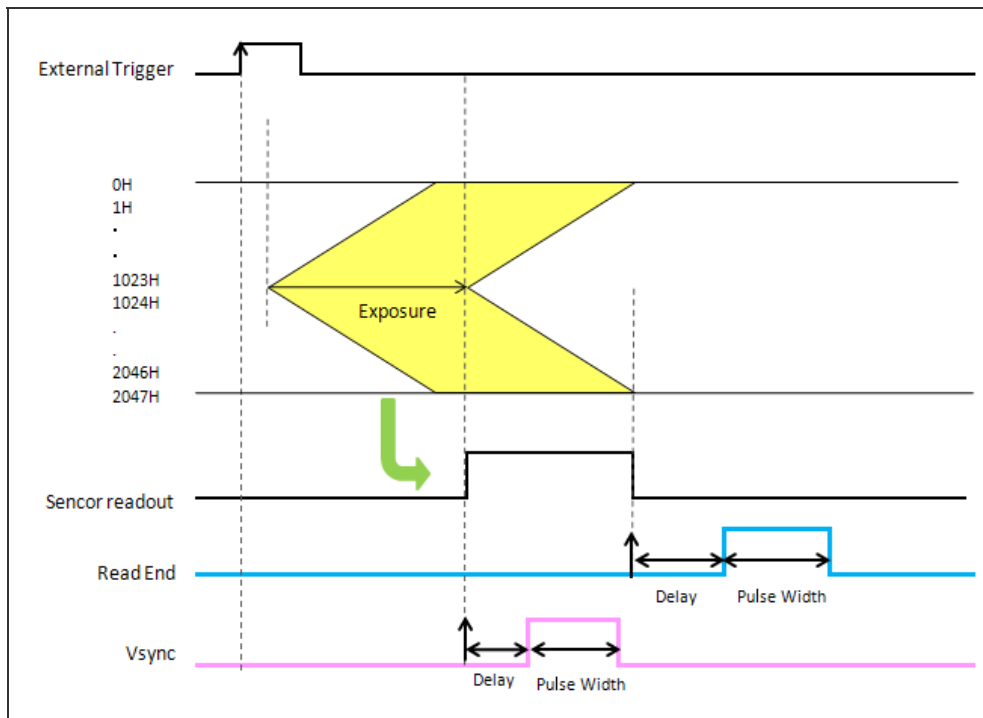

Figure 9-10

9-6-3-3 Trigger ready output

The trigger ready output is useful to make the frame intervals as short as possible in external trigger mode. For example, when the camera is working in the edge trigger mode, the next frame can start after the previous frame exposure is done. Thus, the camera cannot accept a trigger for the next frame during the exposure period. To reduce useless time to be as short as possible, it is necessary to know the period when the camera can accept a trigger for the next frame. The trigger ready output shows the trigger ready period when the camera can accept an external trigger in the external trigger mode.

9-6-3-4 Multi-channel sync

The camera provides 3 programmable timing outputs from Timing out connector 1, 2 and 3 in a sequence. For example, these programmable timing outputs are useful to control a light source and get a color image.

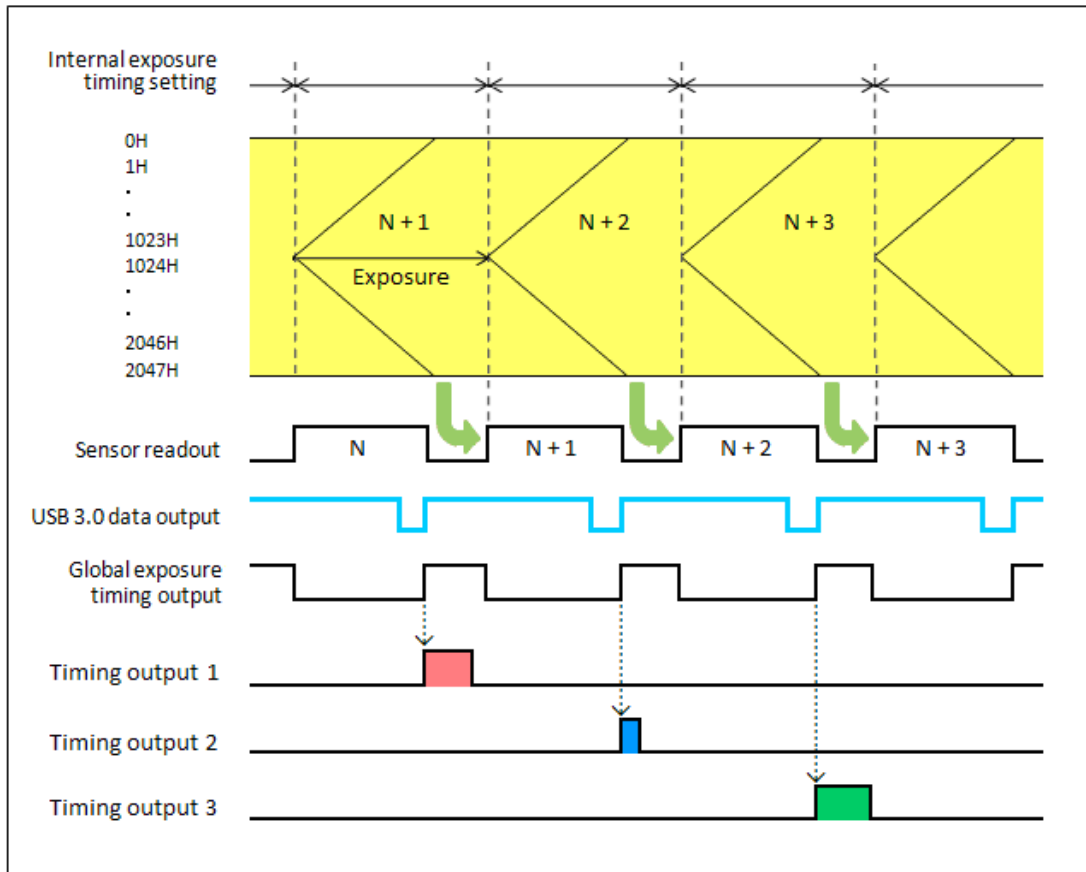

Figure 9-11

9-6-4 GLOBAL RESET

Global reset function enables to reset the electric charge of all pixels at the same time. Then all pixels can start exposure at the same time.

Global reset can work with Edge trigger mode and Level trigger mode.

9-6-4-1 Edge trigger mode

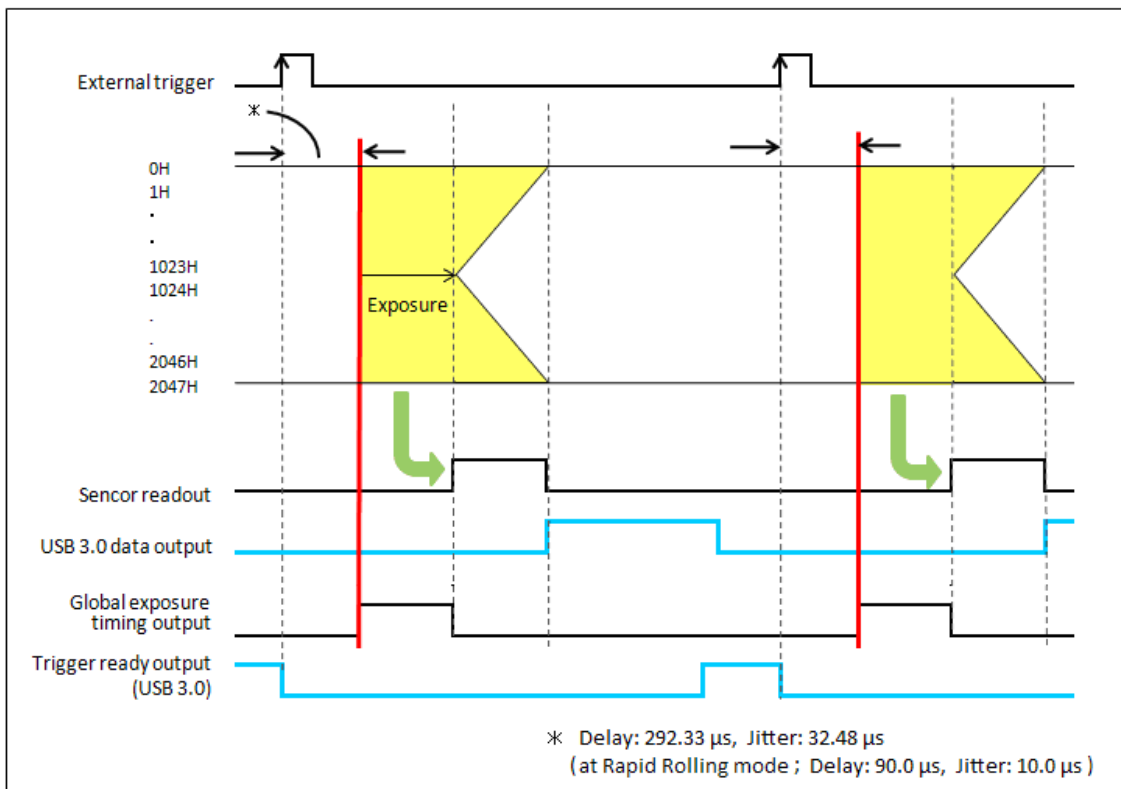

Figure 9-12

9-6-4-2 Level trigger mode

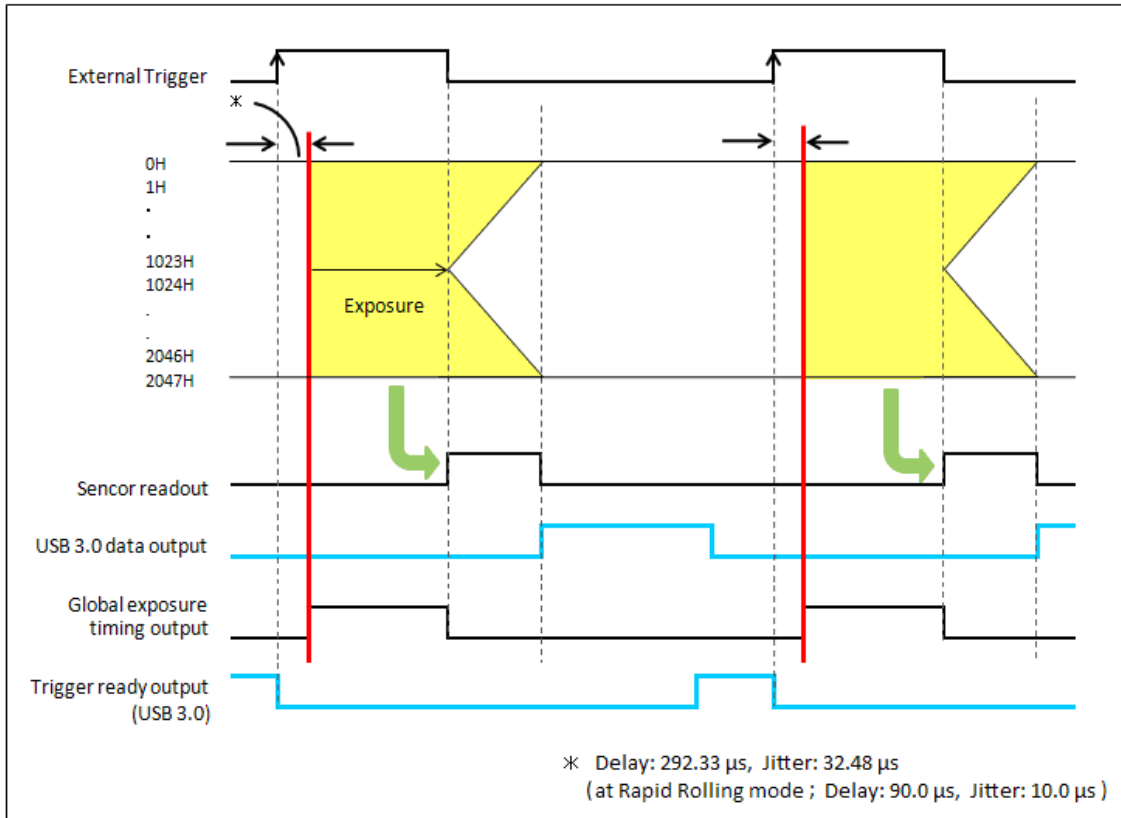

Figure 9-13

9-7 REAL-TIME CORRECTION FUNCTIONS

There are a few pixels in FL-400 that have slightly higher readout noise performance compared to surrounding pixels. The camera has real-time variant pixel correction features to improve image quality. The correction is performed in real-time without sacrificing the readout speed at all. This function can be turned ON and OFF. (Default is ON)

10. PRECAUTION WHEN USING FL-400

This camera uses FL-400 (scientific CMOS image sensor). Careful attention must be paid to the following points when using FL-400:

(1) White spot

Subjecting FL-400 to extended exposures may cause failure in part of the silicon wafer, resulting in white spots. Currently this phenomenon is not currently preventable. If FL-400 is at a fixed temperature, recurrence of the white spot increases proportionally with the exposure time, so this can be rectified with dark subtraction*. Cosmic ray may generate white spot.

* After acquiring an image using a certain exposure time is loaded, the FL-400 is exposed to darkness for the same amount of time, and another image is obtained. After this, the difference between the images is determined, and the data for the dark portion of the original image is nullified.

(2) Folding distortion

A rough-edged flicker may be visible when imaging striped patterns, lines, and similar subject matter.

(3) Over light



CAUTION

- Be careful not to input too strong light such as high-energy laser into FL-400 because FL-400 may be damaged by over light.

11. MAINTENANCE

11-1 CARE

Perform cleaning of the camera with the dry soft cloth.



- Do not wipe with a damp cloth or unclean cloth.

Then, the glass window on the image sensor should be cleaned according to the following.

- (1) Blow the dust from the glass window with an air duster.
- (2) Moisten a lens cleaning paper with a little ethanol, and wipe over center area of the window, gently.



- Use Lens Cleaning Paper for cleaning of glass window in front of the image sensor.



- Please use a plastic tweezers and take extra care not to scratch the glass window with the tweezers. Even with plastic tweezers, there is possibility to make scratch on the glass window in case tweezers touch it.



- Please avoid touching the surrounding parts of image area when wiping the glass window.

- (3) Confirm whether dust is not left.

Attach the camera to an optics, and check if there is dust or not under the uniform light condition. If there is dust on the image, please clean the glass window again.

12. TROUBLESHOOTING CHECKLIST

If an abnormality occurs, look up the possible causes in the following tables and, if necessary, report the details to Hamamatsu subsidiary or local distributor.

12-1 IMAGE IS NOT TRANSFERRED

Cause	Measures	Chapter
AC adaptor or other cable is loose	Reconnect the cable	7
AC adaptor or other cable is broken	Replace the cable	7
The correct command has not been sent to the camera	Recheck command	

12-2 ALTHOUGH IMAGES ARE TRANSFERRED

(1) Scratches or discoloration visible on the screen

Cause	Measures	Chapter
Lens is dirty	Wipe the lens	11

(2) Image is blurred

Cause	Measures	Chapter
Lens is not focused	Contact Hamamatsu subsidiary or local distributor	16
Condensation appear	Confirm the operating environmental conditions	13

(3) Only shadowed images are output

Cause	Measures	Chapter
Lens mount cap has been left on	Remove the cap	
Amount of light is too much or too low	Reduce amount of light	

(4) All screens overflow

Cause	Measures	Chapter
Too much amount of light	Reduce amount of light	
Contrast enhancement is too high	Reduce gain	

(5) Noise appears on the screen

Cause	Measures	Chapter
Exogenous noise	Find and remove cause	
Poor connection of internal connector	Contact Hamamatsu subsidiary or local distributor	16
Defective circuit system		

13. SPECIFICATIONS

13-1 CAMERA SPECIFICATIONS

(1) Electric specifications

Imaging device	Scientific CMOS image sensor FL-400	
Effective number of pixels	2048 (H) × 2048 (V)	
Cell size	6.5 μm (H) × 6.5 μm (V)	
Effective area	13.312 mm (H) × 13.312 mm (V)	
Full well capacity (typ.)	30 000 electrons	
Readout speed	33 ms	
	10 ms (Rapid Rolling Mode)	
Readout noise (r.m.s)	1.5 electrons (typ.)	
	1.9 electrons (typ.) (Rapid Rolling Mode)	
Dynamic range *1	33 000 : 1	
Cooling method	Peltier device + Forced air-cooled	
Cooling temperature	+ 10 °C (Ambient temperature: + 10 °C to + 30 °C)	
Frame rate	at Full resolution	30 frame/s
	at 1024 lines at center position	60 frame/s
	at 8 lines at center position	7696 frame/s
	at Horizontal 512 pixels at 8 lines at center position	25 000 frame/s (Rapid Rolling Mode)
Readout mode	Normal readout mode	1×1
	Binning readout mode	2×2,4×4 (Digital binning) *2
	Sub-array readout mode	Configurable for each vertical 8 pixels and horizontal 512 pixels.
Dark current	0.6 electron/pixel/s (at Cooling temperature: + 10 °C)	
Exposure time	Free running mode	3 ms to 10 s
		1 ms to 10 s (Rapid Rolling Mode)
	Free running mode / Sub-array mode	129.99 μs to 10 s
		40 μs to 10 s (Rapid Rolling Mode)
External trigger mode	3 ms to 10 s	
	1 ms to 10 s (Rapid Rolling Mode)	
A/D bit	16 bit	
Linearity	Less than 3 %	
Conversion factor	0.46 electrons/count (typ.)	
Dark offset	100 counts (at Normal readout)	
External trigger Function	Edge trigger / Global reset edge trigger Level trigger / Global reset level trigger Synchronous readout trigger Start trigger	
External signal input	External input (SMA connector)	
External trigger input level	3.3 V LVCMOS level	
External trigger output level	3.3 V LVCMOS level	

External trigger delay function	0 μ s to 10 s (10 μ s steps)
External signal output	Global exposure timing output Trigger ready output Programmable timing output 1 Programmable timing output 2 Programmable timing output 3 (Continuous High or Low output) Multi-channel Sync
Image processing function	Real-time offset correction Real-time gain correction Real-time defect pixel correction (Default)
Interface	USB 3.0 Super Speed
Lens mount	C11440-42U: C-mount C11440-42U01: F-mount

* 1 Calculated from the ratio of the full well capacity and the readout noise.

* 2 Digital binning processing in the camera.

(2) Power supply specifications

Camera	Input power supply	DC12 V
	Power consumption	26 W
AC adaptor	Input power supply	AC100 V to AC240 V 50 Hz/60 Hz
	Typical output	DC12 V
	Power consumption	75 VA

Note

- Fluctuations of input power supply voltages are not to exceed $\pm 10\%$ of the nominal voltage.

(3) Operating environment

Ambient operating temperature	0 °C to + 40 °C
Ambient storage temperature	-10 °C to + 50 °C
Ambient operating humidity	Less than 70 %, no condensation
Ambient storage humidity	Less than 90 %, no condensation
Operating space	Indoor, altitude up to 2000 m

(4) Dimensional outline and weight

Dimensional outline	85 mm (W) \times 85.5 mm (H) \times 120.5 mm (D)	
Weight	Camera	Approx. 1.1 kg
	AC adaptor + power supply cord	Approx. 1.0 kg

Note

- Please see Chapter 14 [DIMENSIONAL OUTLINES] for detail of dimensions.

(5) Applicable standards

EMC	EN61326-1: 2006 Class A
-----	-------------------------

13-2 SPECTRAL RESPONSE CHARACTERISTICS

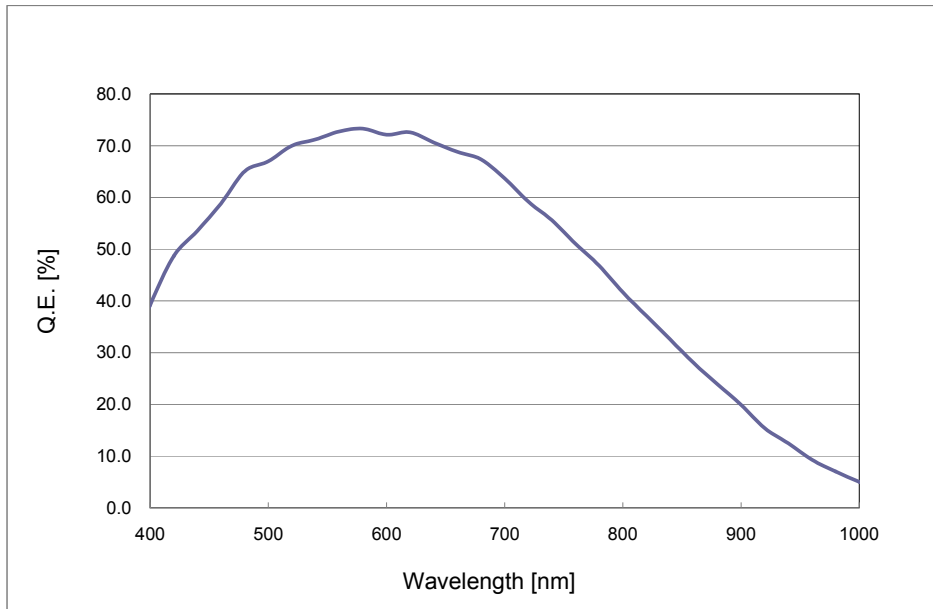
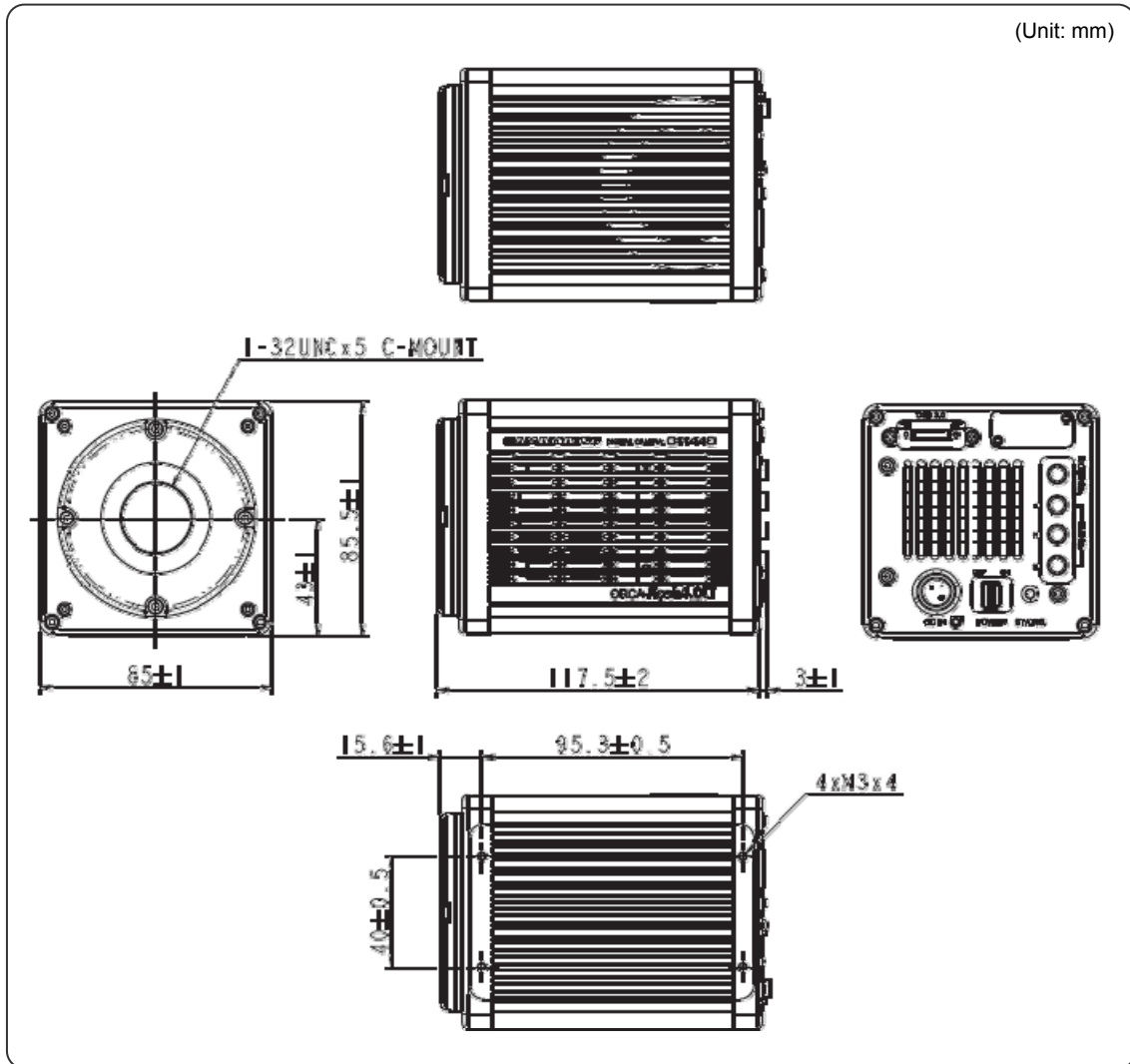

Figure 13-1

14. DIMENSIONAL OUTLINES

14-1 C11440-42U for C-mount



14-2 C11440-42U01 for F-mount

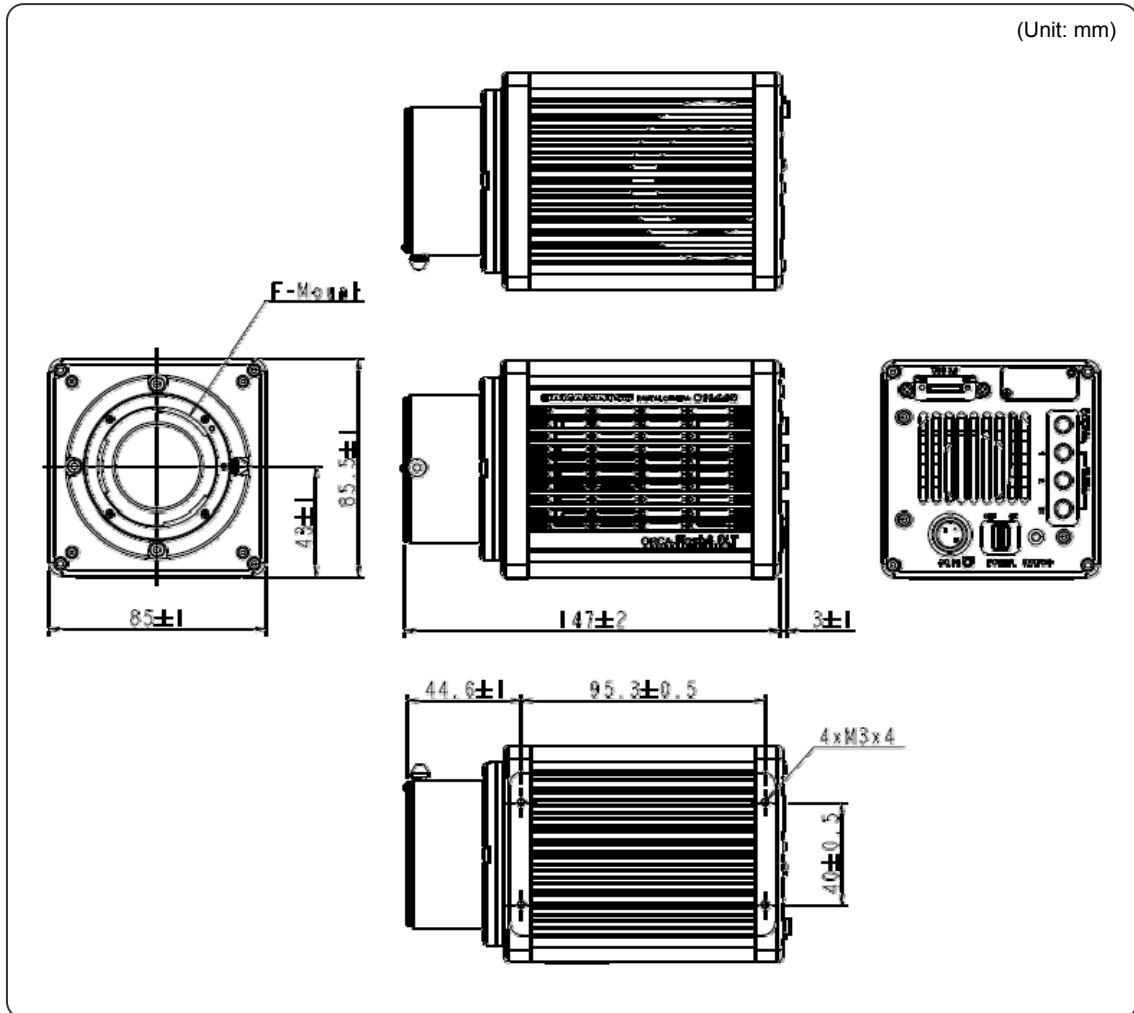

15. WARRANTY

Hamamatsu Photonics have fully inspected this system and checked that its performance conforms to specifications. In the unlikely event of breakdown or other malfunction, contact Hamamatsu subsidiary or local distributor.

- (1) Unless otherwise stated by Hamamatsu subsidiary or local distributor, this system is under warranty for 24 months from the delivery date.
 - Degradation with cosmic rays, the radiation (X-rays, gamma rays, UV light, etc.) of FL-400 is excepted.
- (2) The warranty only covers defects in the materials and manufacturing of the system. You may be liable for repairs during the warranty period in the event of a natural disaster or if you handle the system contrary to the instructions in this manual, use it without due caution, or try to modify it.
- (3) We will repair the system or replace it, subject to availability, free of charge within the terms of the warranty.

REPAIRS

- (1) If you notice anything wrong with the camera, confirm whether or not it is malfunctioning by referring to the troubleshooting checklist in this instruction manual. You must first clarify the symptoms in order to avoid any misunderstanding or error.
- (2) If you have any trouble or are unclear about anything, contact Hamamatsu subsidiary or local distributor giving the product name, serial number and details of the problem. If Hamamatsu Photonics consider the problem to be a malfunction, we will decide whether dispatch an engineer or have the camera returned to us for repairs.

16. CONTACT INFORMATION

HAMAMATSU PHOTONICS K. K., Systems Division

812 Joko-cho, Higashi-ku, Hamamatsu City, 431-3196, Japan
Telephone (81) 53-431-0124, Fax: (81) 53-435-1574
E-mail: export@sys.hpk.co.jp

U.S.A. and Canada

Hamamatsu Corporation

360 Foothill Road, Bridgewater, N.J. 08807-0910, U.S.A.
Telephone: (1) 908-231-0960, Fax: (1) 908-231-0852
E-mail: usa@hamamatsu.com

Germany

Hamamatsu Photonics Deutschland GmbH

Arzbergerstr. 10, D-82211 Herrsching am Ammersee, Germany
Telephone: (49) 8152-375-0, Fax: (49) 8152-265-8
E-mail: info@hamamatsu.de

France

Hamamatsu Photonics France S.A.R.L.

19, Rue du Saule Trapu, Parc du Moulin de Massy, 91882 Massy Cedex, France
Telephone: (33) 1 69 53 71 00, Fax: (33) 1 69 53 71 10
E-mail: infos@hamamatsu.fr

United Kingdom

Hamamatsu Photonics UK Limited

2 Howard Court, 10 Tewin Road, Welwyn Garden City Hertfordshire AL7 1BW, United Kingdom
Telephone: (44) 1707-294888, Fax: (44) 1707-325777
E-mail: info@hamamatsu.co.uk

North Europe

Hamamatsu Photonics Norden AB

Smidesvågän 12, SE-171 41 Solna, Sweden
Telephone: (46) 8-509-031-00, Fax: (46)8-509-031-01
E-mail: info@hamamatsu.se

Italy

Hamamatsu Photonics Italia S.R.L.

Strada della Moia, 1/E 20020 Arese (Milano), Italy
Telephone: (39) 02-935 81 733, Fax: (39) 02-935 81 741
E-mail: info@hamamatsu.it

China

Hamamatsu Photonics (China) Co., Ltd.

1201 Tower B, Jiaming Center, 27 Dongsanhuan Beilu, Chaoyang District, Beijing 100020, China
Telephone: (86)10-6586-6006, Fax: (86)10-6586-2866
E-mail: hpc@hamamatsu.com.cn

- *The contents of this manual are subject to change without notice.*
- *The unauthorized reproduction or distribution of parts or all of this manual is prohibited.*
- *If one of the following problems occurs, please contact Hamamatsu Photonics. (See the CONTACT INFORMATION.) We will deal with the problem immediately.*
 - *Some contents of the manual are dubious, incorrect or missing.*
 - *Some pages of the manual are missing or in the wrong order.*
 - *The manual is missing or dirty.*