



ACCU-SCOPE®

MICROSCOPY & IMAGING SOLUTIONS

3000-LED
Clinical Microscope



Empowering Discovery. Advancing Results.

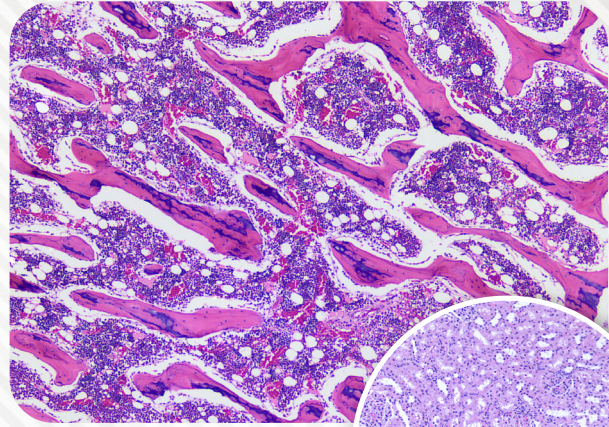

Brightfield Observation

The 3000-LED series delivers brilliant and crisp brightfield images thanks to its Abbe condenser, 3W color-balanced LED illumination, and standard Plan Achromat objectives. Contrast can be easily adjusted using the condenser iris diaphragm.

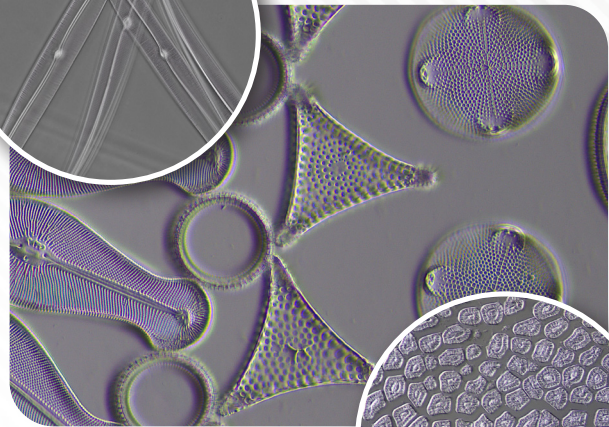
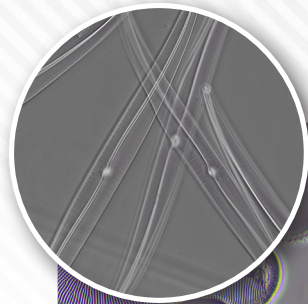
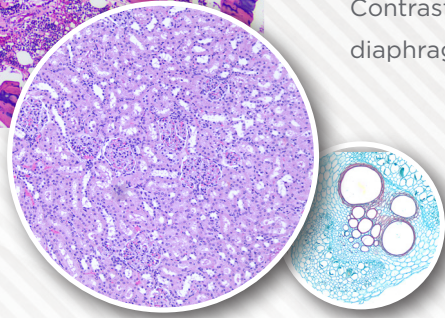

Phase Contrast

Phase contrast observation is available for 10x, 20x, 40x, and 100x objective magnifications. Pre-centered phase contrast annuli (10x/40x and 20x/100x) are mounted in sliders that slide easily into the slot in the Abbe condenser. A green filter provides additional contrast.

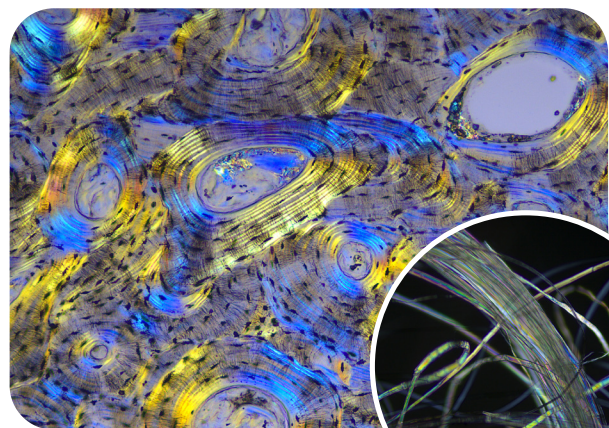

Simple Polarization

Easily add simple polarization to your 3000-LED series microscope. Place the rotatable polarizer on top of the LED illumination housing (requires field iris upgrade). The analyzer sets in the top of the microscope body below the viewing head. Rotate the polarizer until the field is black, then enjoy the colors! A gout polarizer is also available.

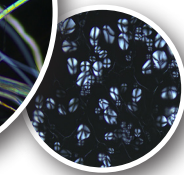
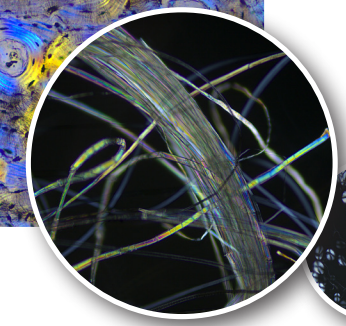



Choose Your Model



3000-LED



3000-LED-SPH



3000-LED-DM



3001-LED



3001-LED-SPH



3001-LED-HD

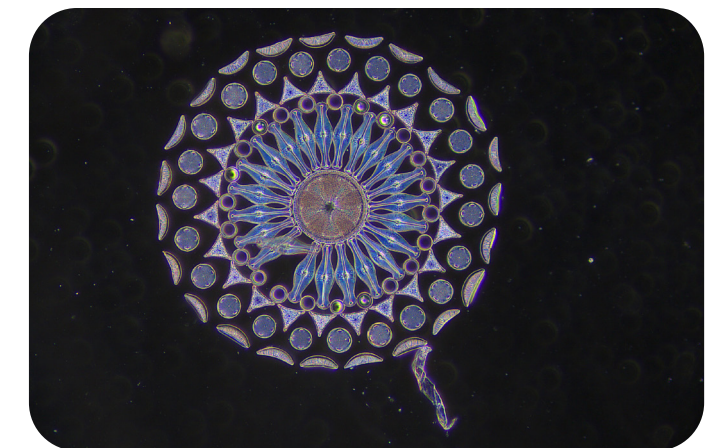
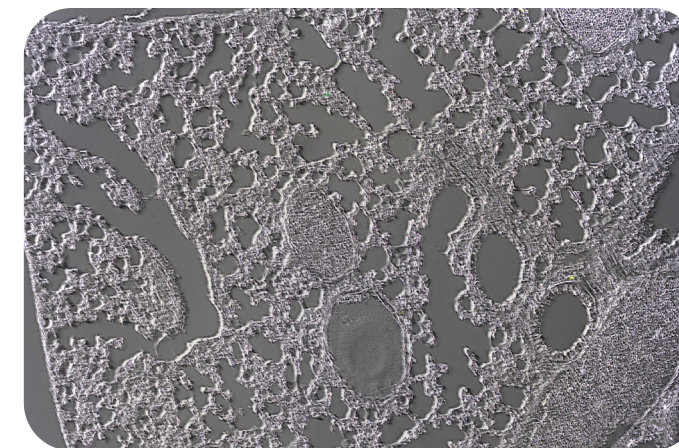
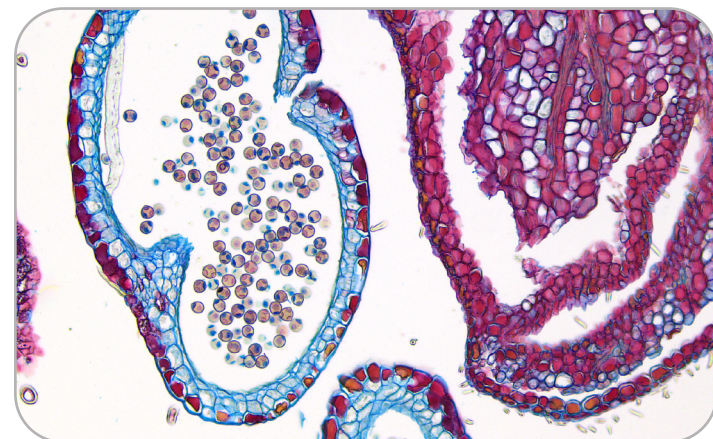
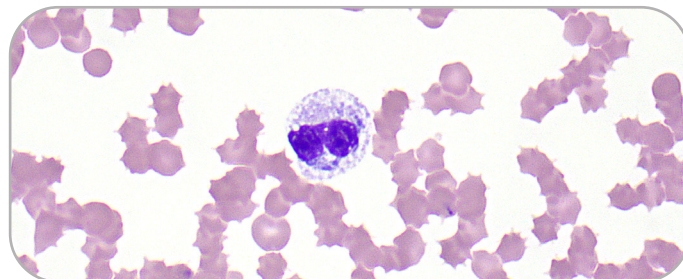
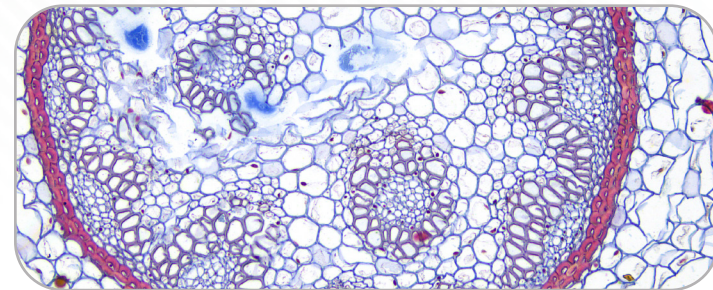
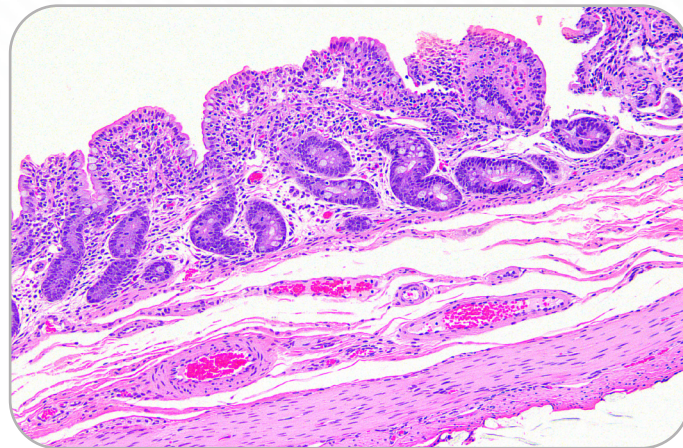

3000-LED: Dependable Routine Clinical Microscope

The ACCU-SCOPE® 3000-LED Microscope Series delivers excellent optical performance, value and resolution to meet the exacting standards of life science professionals and students. With a best-in-class 20mm field of view and super-bright LED illumination, the 3000-LED Series produces high contrast images with outstanding resolution. Several models accept digital cameras for documentation, instruction and even greater ergonomics.

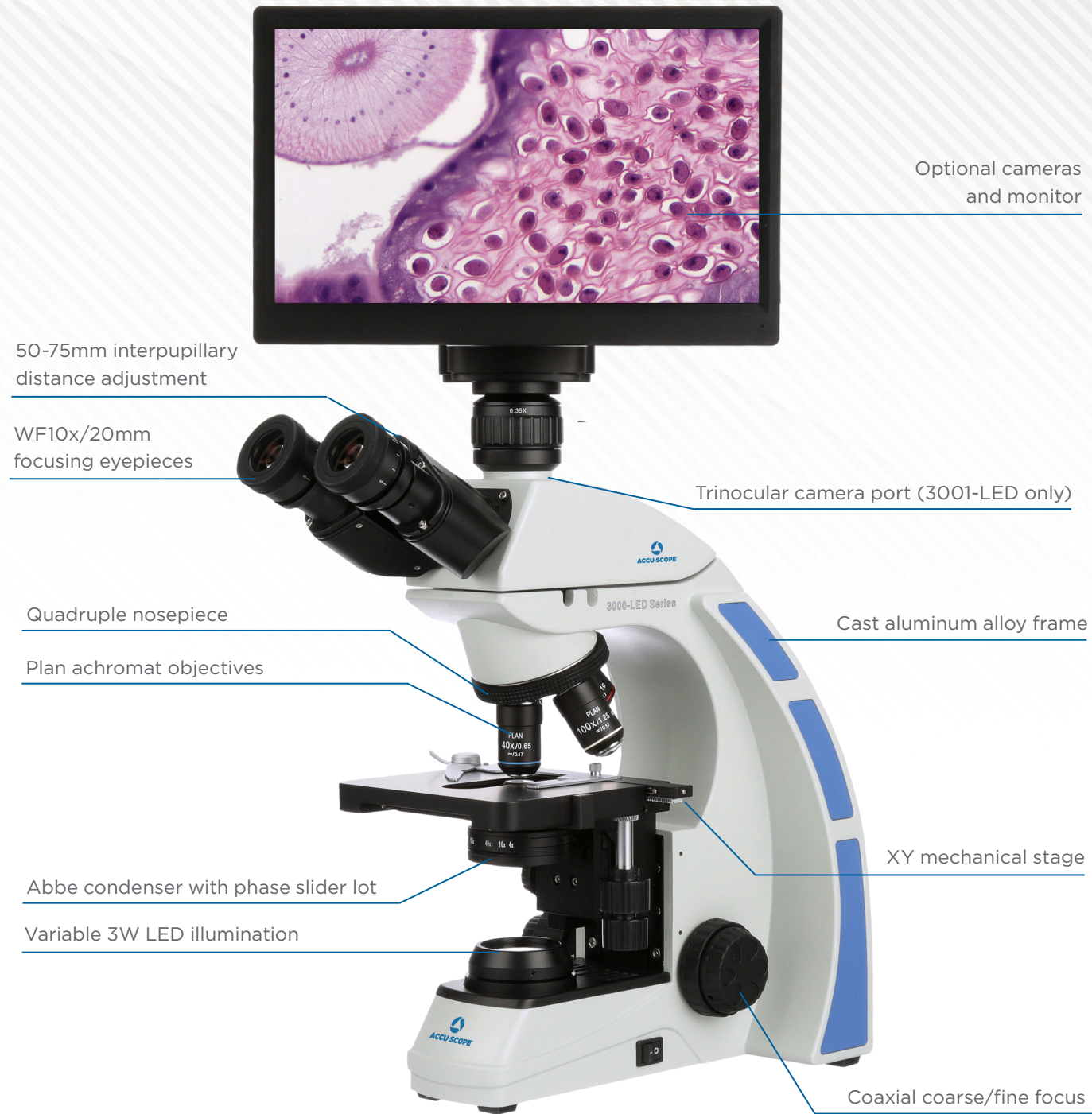

SPECIFICATIONS

Viewing Body	Binocular or trinocular (fixed 50:50 light split) Siedentopf type viewing head, inclined 30°; rotatable 360°; interpupillary distance adjustment 50-75mm
Optical System	Infinity optical system, f = 180mm, anti-mold
Objectives	Plan Achromat 2x, 4x, 10x, 20x, 40xR*, 50xR* oil, 60xR*, 100xR* water, 100xR* oil; Plan Phase 10x, 20x, 40xR*, 100xR* oil <i>*Spring-loaded</i>
Eyepieces	WF10x/20mm eyepieces w/diopter, locked in to prevent tampering, accepts 20.5mm reticle; optional eyepieces include WF10x/18mm, WF10x/20mm (no diopter), WF10x/20mm (w/diopter and 10mm/100 division reticle w/crossline), WF10x/20mm (w/eyepiece pointer)
Nosepiece	Rear facing quadruple, ball bearing nosepiece with positive click stops to ensure parcentration; optional quintuple nosepiece
Focusing System	Coaxial focusing system with adjustable tension control and upper limit stop to prevent accidental damage to slides; all metal gears, brass for fine focus gear
Stand	Cast aluminum alloy
Stage	Stage size 140mm x 132mm with X-Y movement range of 76mm x 50mm
Condenser	Abbe condenser NA 1.25 (with slot for sliders) with iris diaphragm
Illumination	3 watt LED with variable intensity control; LED bulb is rated for over 25,000 hours of continued use; universal power supply 110-240v
Accessories	Dust cover, instruction manual included
Optional Accessories	Slider phase contrast set; darkfield slider (4x - 40x); field iris upgrade; simple polarizer/analyzer; gout polarizer; reticles; cameras and adapters; microscope carry case
Warranty	5 year limited warranty for parts, labor, and electronic components; 1 year warranty on LED bulb

Dimensional Diagrams (in mm)

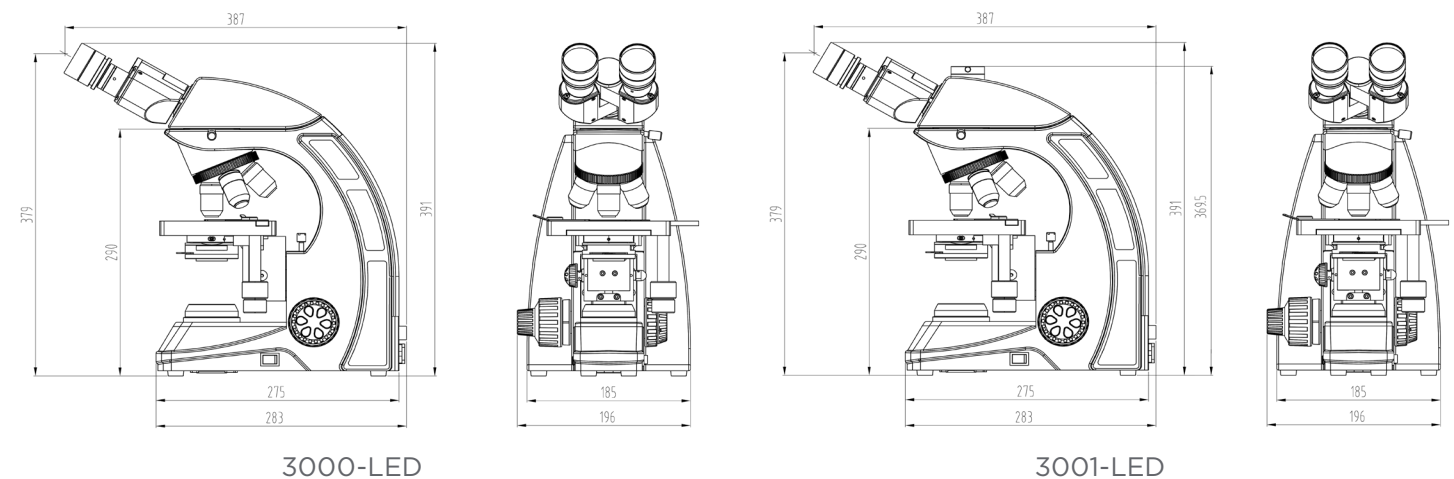



MICROSCOPY & IMAGING SOLUTIONS

WWW.ACCU-SCOPE.COM

73 Mall Drive, Commack, NY 11725
info@accu-scope.com • 631-864-1000



Copyright © 2023 ACCU-SCOPE Inc. All rights reserved. Printed in the U.S.A.
ACCU-SCOPE Inc. reserves the right to change and improve specifications
without notice due to technological or manufacturing advances.

v062823