

CUTSHEET

Front View

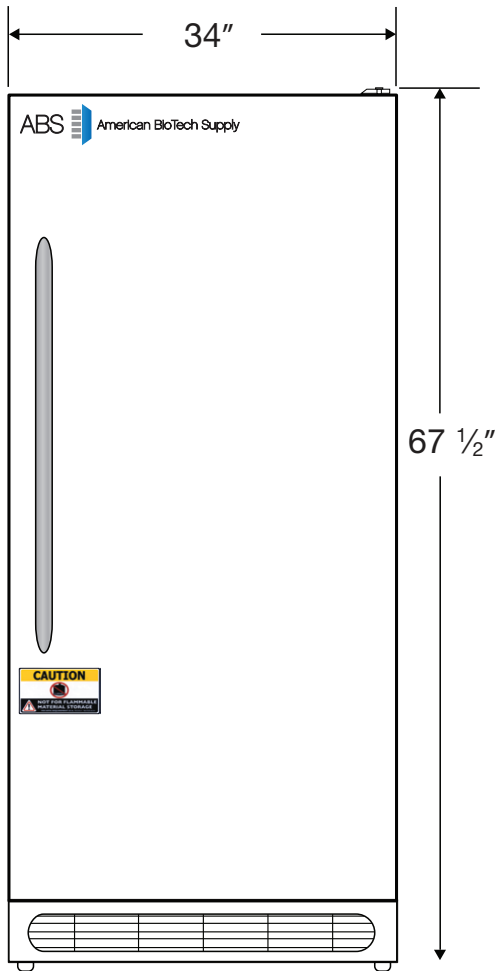

Side View

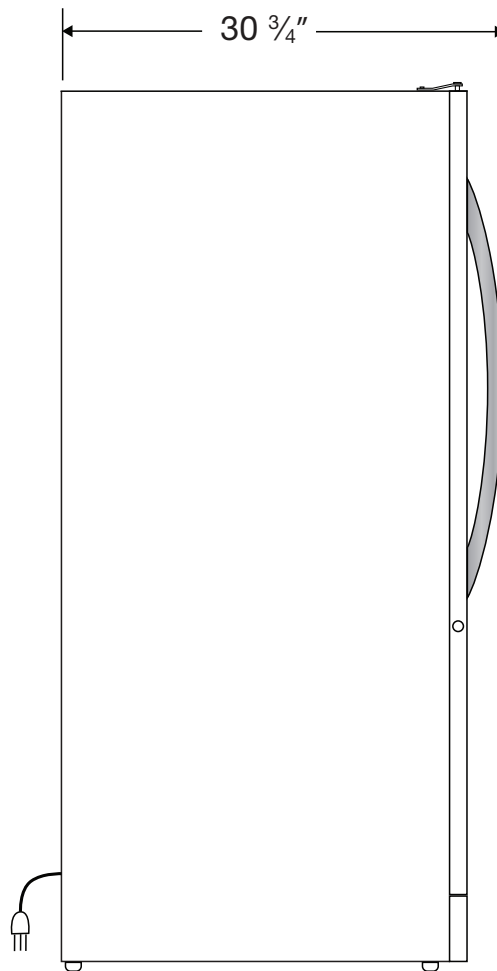

Top View

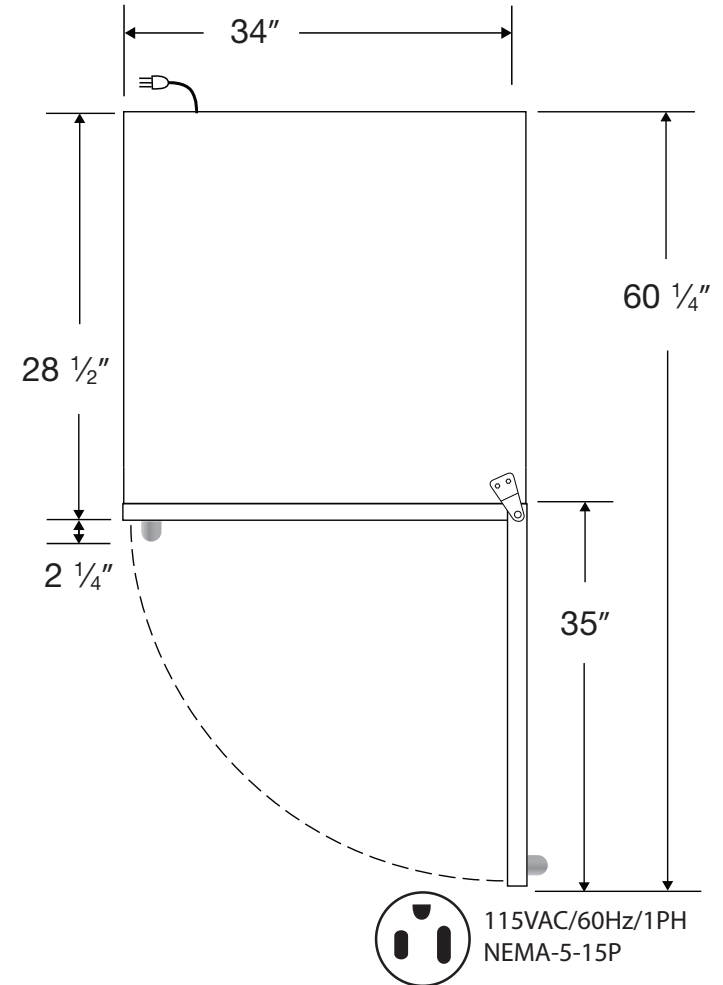

115VAC/60Hz/1PH  
NEMA-5-15P

Cu. Ft	Defrost	Door	Int Door	Shelves	W"	D"	H"	Refrigerant	H.P.	Amps	Weight
17	Manual	1 Solid	0	3 Fixed	34	30 3/4	67 1/2	R134a	1/3	5	167 lbs.