

CUTSHEET

Front View

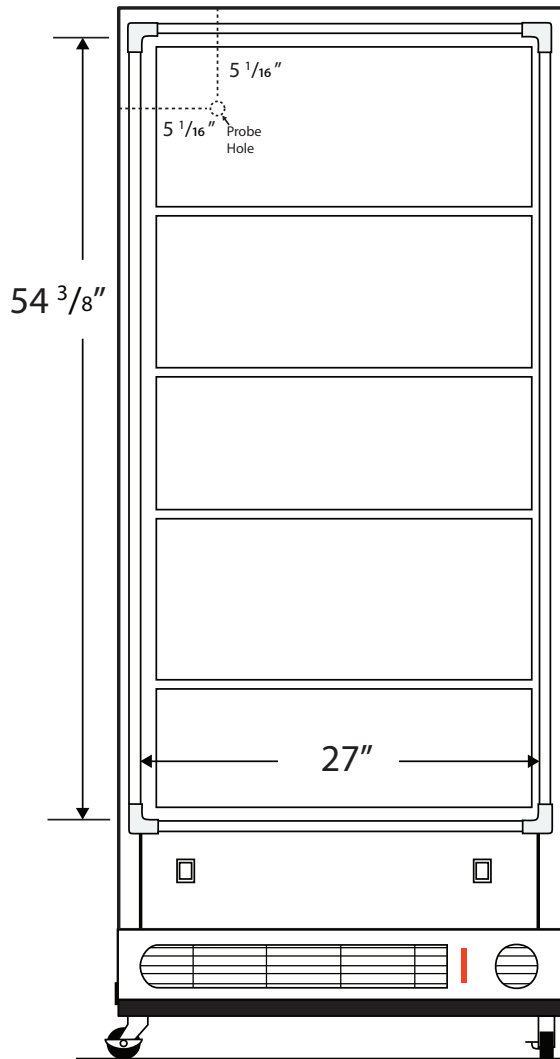

Side View

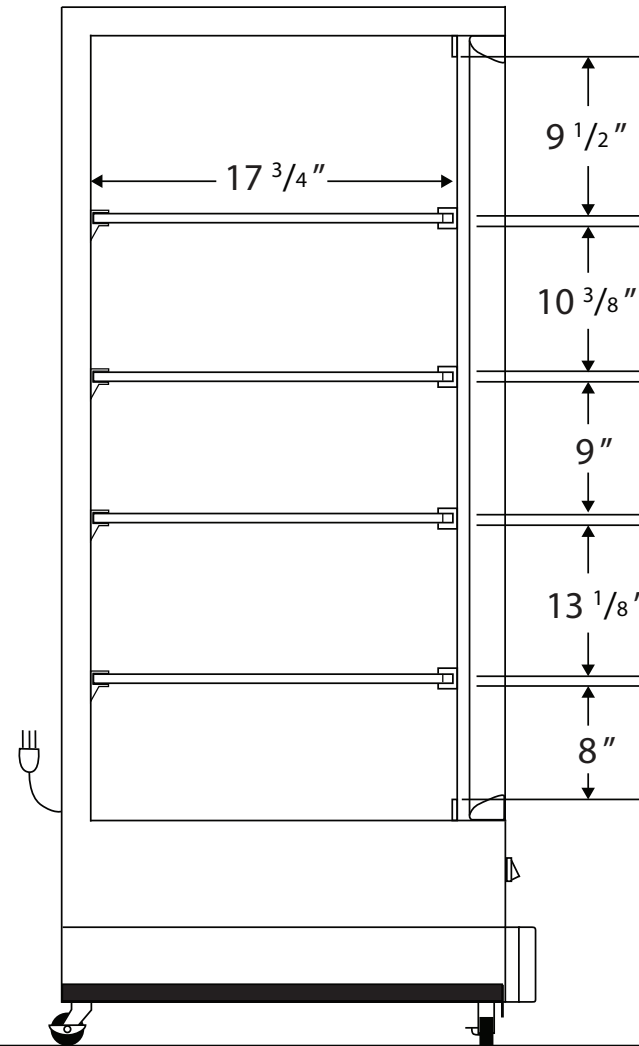

Cu. Ft	Defrost	Door	Int Door	Shelves	Interior Dim.			Refrigerant	H.P.	Amps	Weight
					W"	D"	H"				
20	Manual	1 Solid	5	4 Fixed	27	17 3/4	54 3/8	R134a	1/3	5	254 lbs.

Note: Interior dimensions are estimates and subject to change without notice