

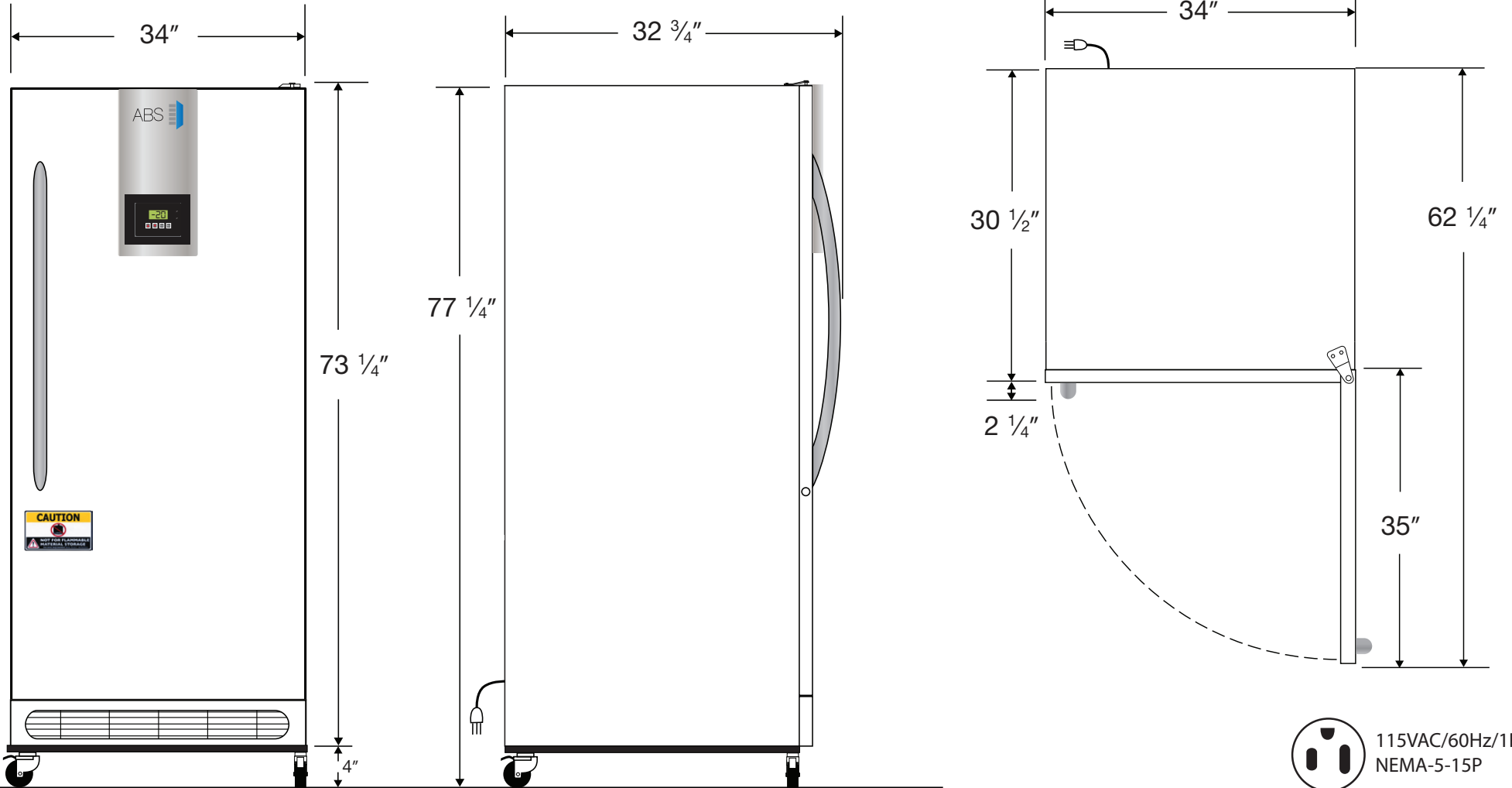

CUTSHEET

Front View

Side View

Top View



 115VAC/60Hz/1PH
NEMA-5-15P

Cu. Ft	Defrost	Door	Int Door	Shelves	W"	D"	H"	Refrigerant	H.P.	Amps	Weight
20	Manual	1 Solid	5	4 Fixed	34	32 3/4	77 1/4	R134a	1/3	5	254 lbs.