

CUTSHEET

Front View

Side View

Top View

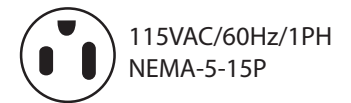
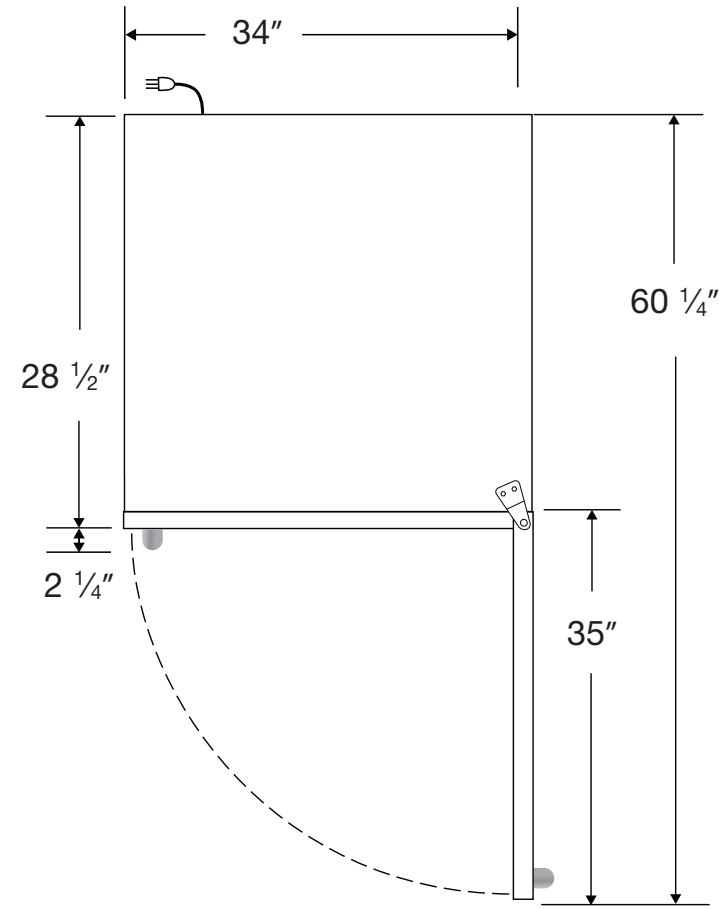
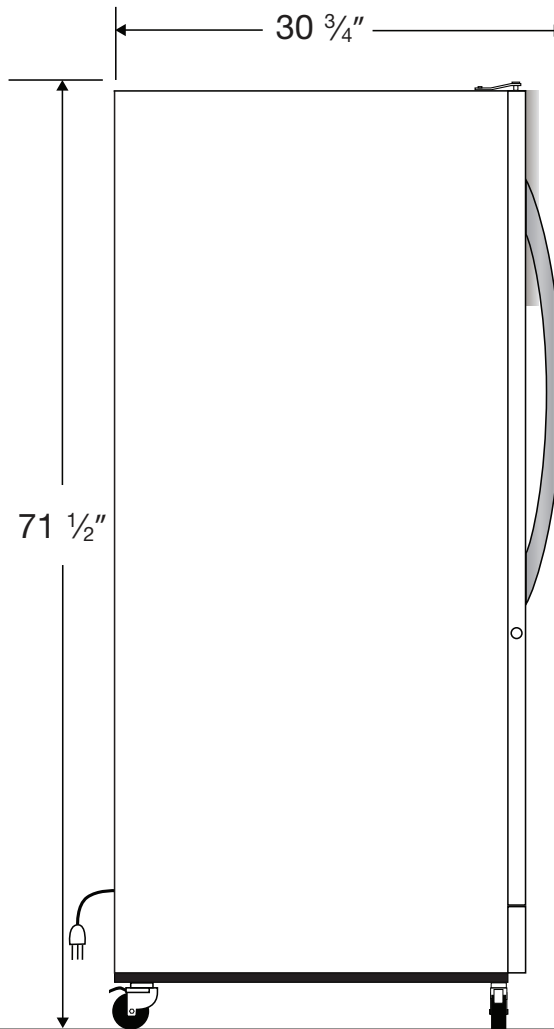
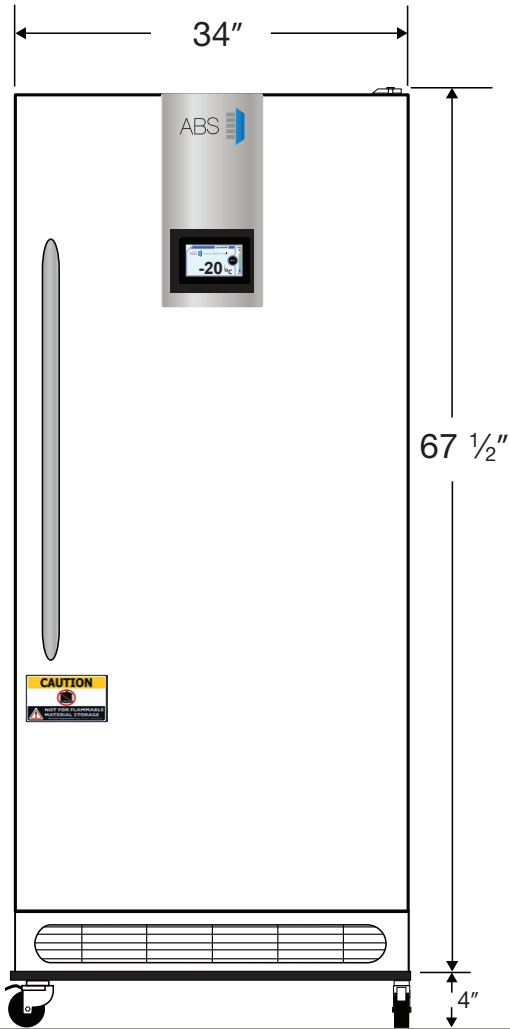

Cu. Ft	Defrost	Door	Int Door	Shelves	W"	D"	H"	Refrigerant	H.P.	Amps	Weight
17	Manual	1 Solid	4	3 Fixed	34	30 3/4	71 1/2	R134a	1/3	5	205 lbs.