

CUTSHEET

Front View

Side View

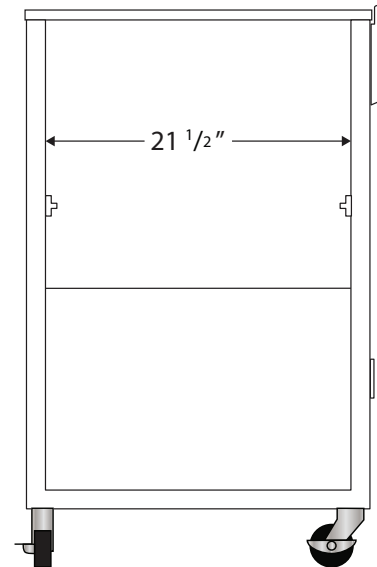
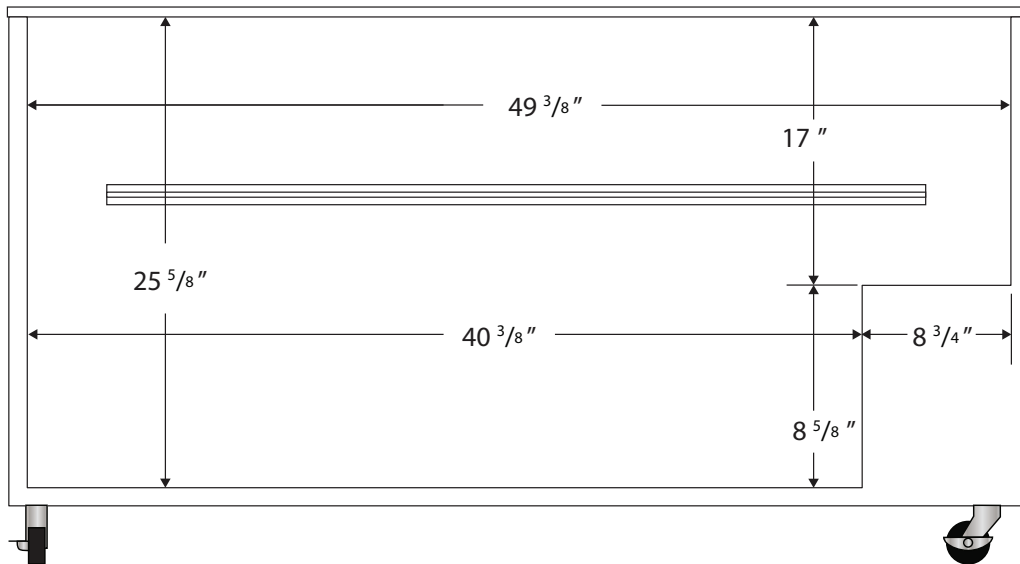

Cu. Ft	Defrost	Door	Int Door	Shelves	Interior Dim.			Refrigerant	H.P.	Amps	Weight
					W"	D"	H"				
15	Manual	1 Solid	0	2 Baskets	49 3/8	21 1/2	25 5/8	R134a	1/4	5	137 lbs.

Note: Interior dimensions are estimates and subject to change without notice