

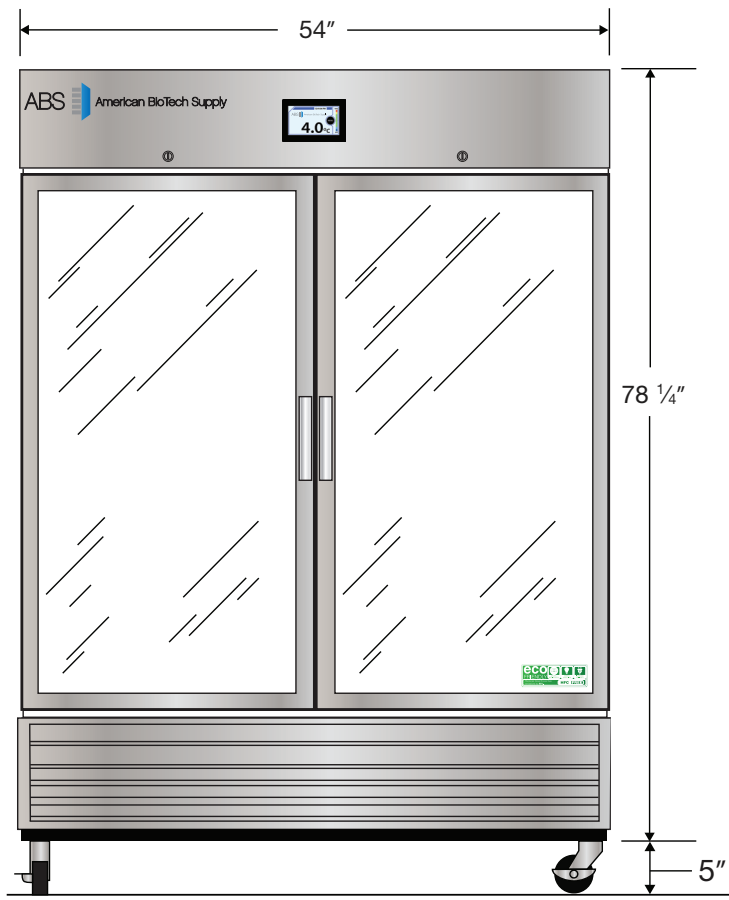

Front View

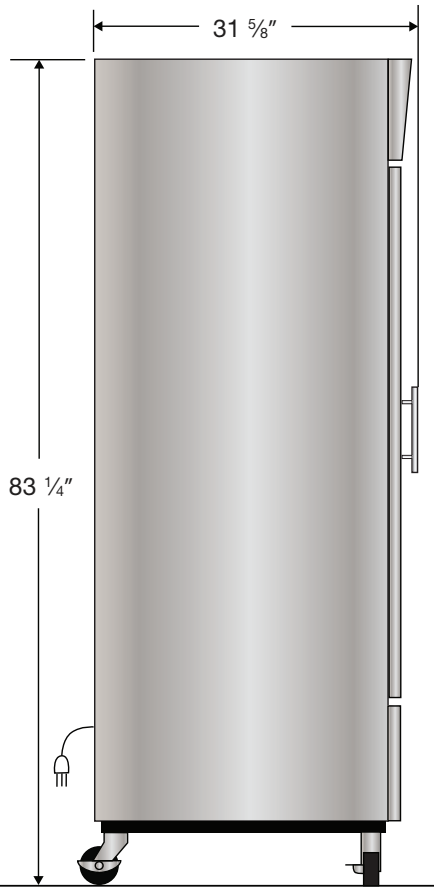

Side View

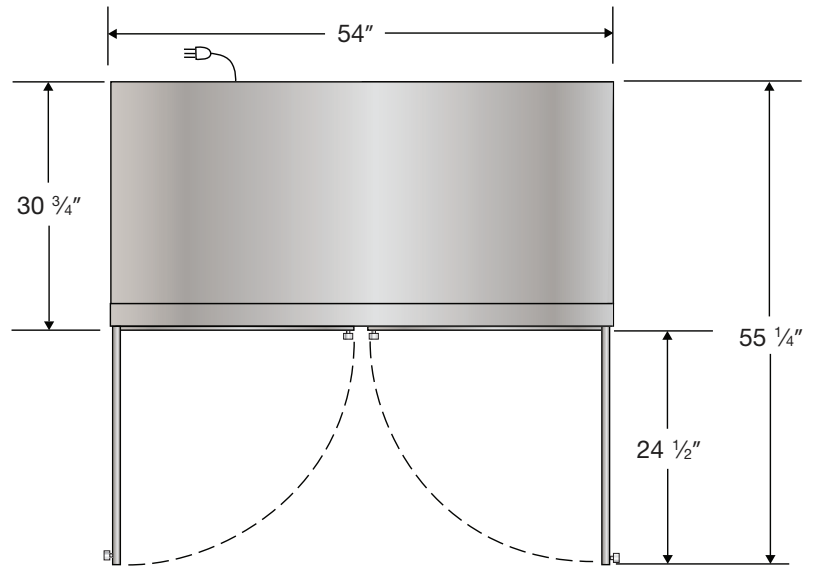

Top View

115VAC/60Hz/1PH
NEMA-5-15P

Cu. Ft	Defrost	Door	Int Door	Shelves	W"	D"	H"	Refrigerant	H.P.	Amps	Weight
49	Cycle	2 Glass	0	6 Adj.	54	31 5/8	83 1/4	R290	1/2	5.4	435 lbs.