

CUTSHEET

Front View

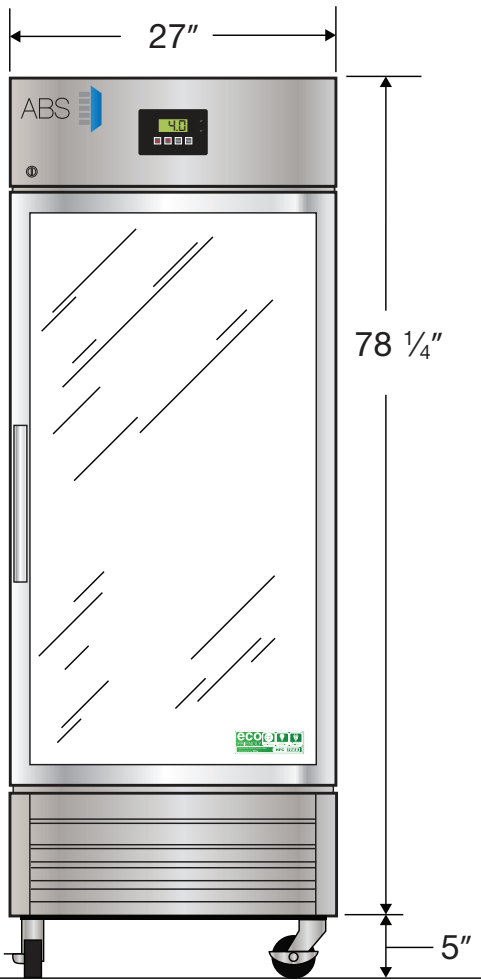

Side View

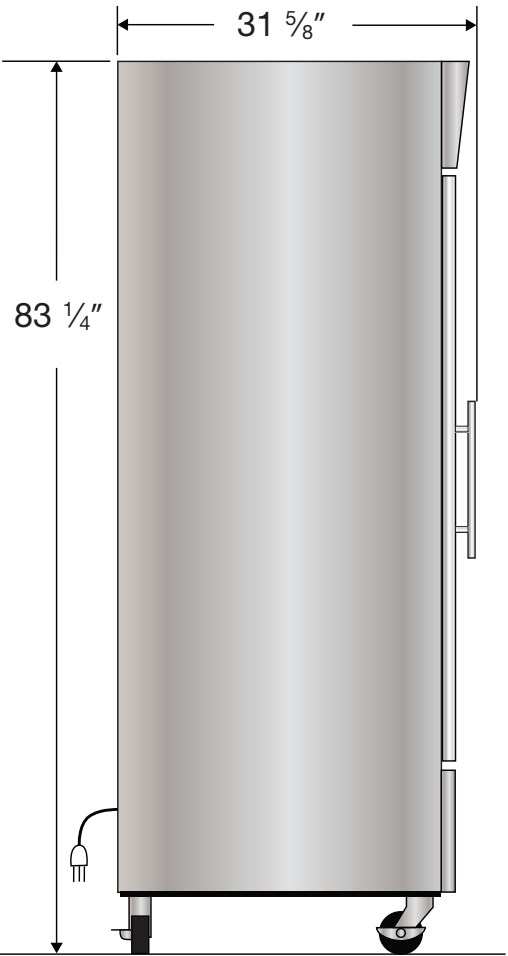

Top View

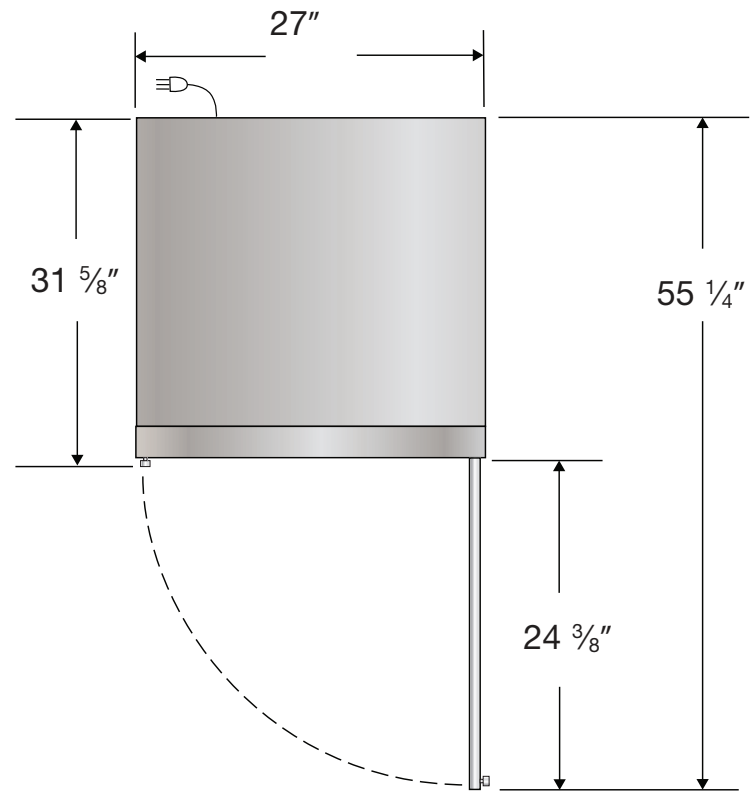

115VAC/60Hz/1PH
NEMA-5-15P

Cu. Ft	Defrost	Door	Int Door	Shelves	W"	D"	H"	Refrigerant	H.P.	Amps	Weight
23	Cycle	1 Glass	0	3 Adj	27	31 5/8	83 1/4	R290	1/4	2.2	290 lbs.