

CUTSHEET

Front View

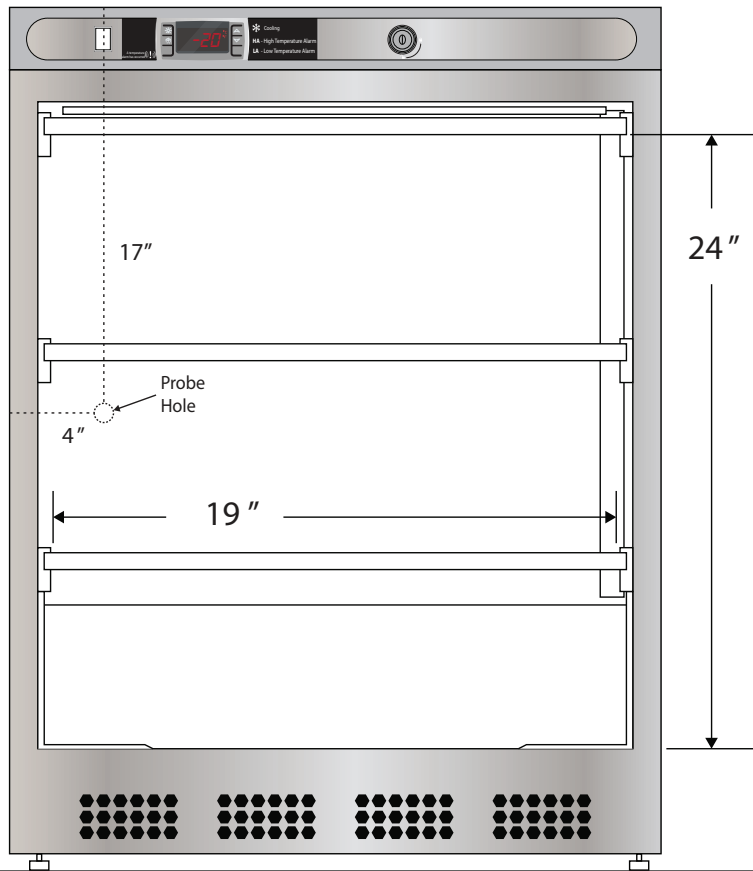

Side View

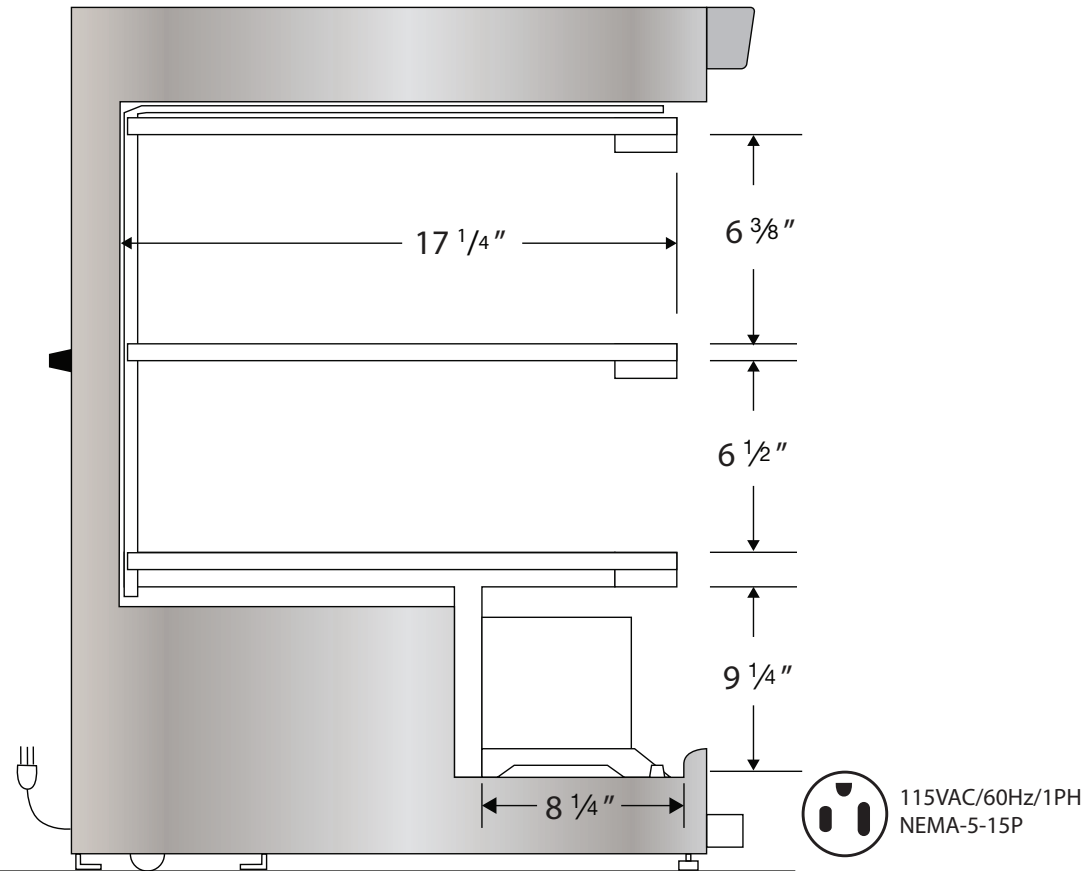

Cu. Ft	Defrost	Door	Int Door	Shelves	Interior Dim.			Refrigerant	H.P.	Amps	Weight
					W"	D"	H"				
4.2	Manual	1 Solid (Reversible)	0	2 Fixed	19	17 1/4	24	R600a	1/8	1.5	100 lbs.

Note: Interior dimensions are estimates and subject to change without notice