

CUTSHEET

Front View

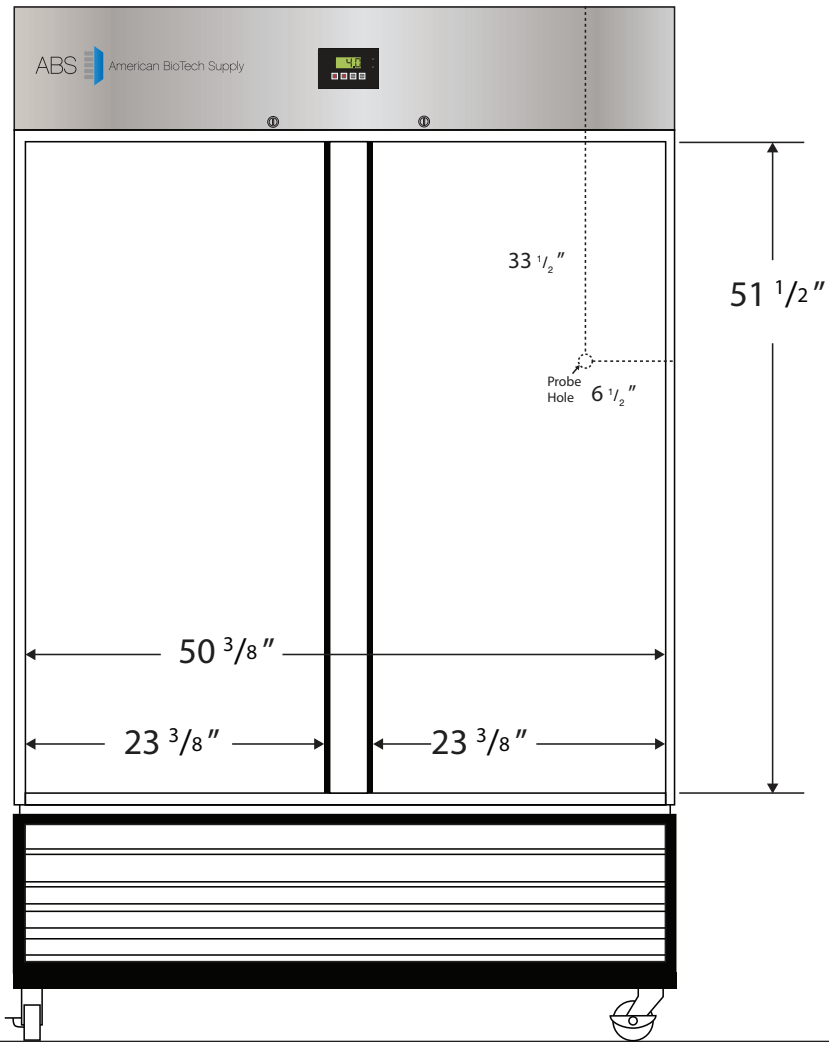

Side View

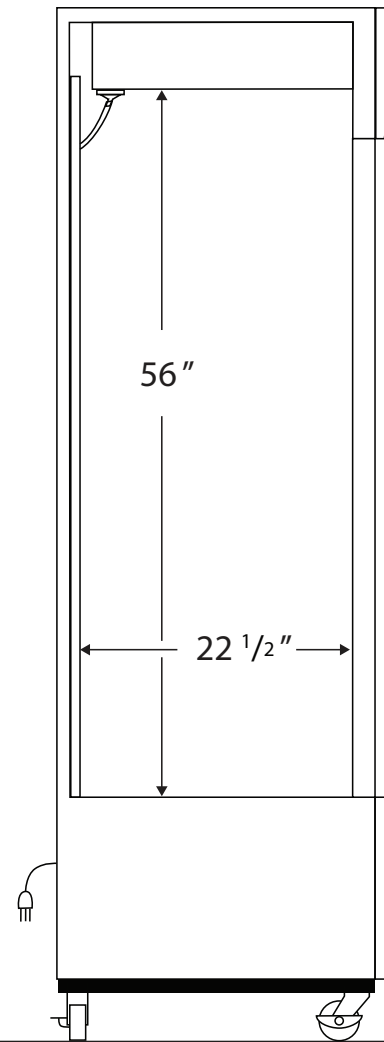

Cu. Ft	Defrost	Door	Int Door	Shelves	Interior Dim.			Refrigerant	H.P.	Amps	Weight
					W"	D"	H"				
49	Cycle	2 Glass	0	8 Adj	50 3/8	22 1/2	56	R290	1/2	8.5	445 lbs.

Note: Interior dimensions are estimates and subject to change without notice