

CUTSHEET

Front View

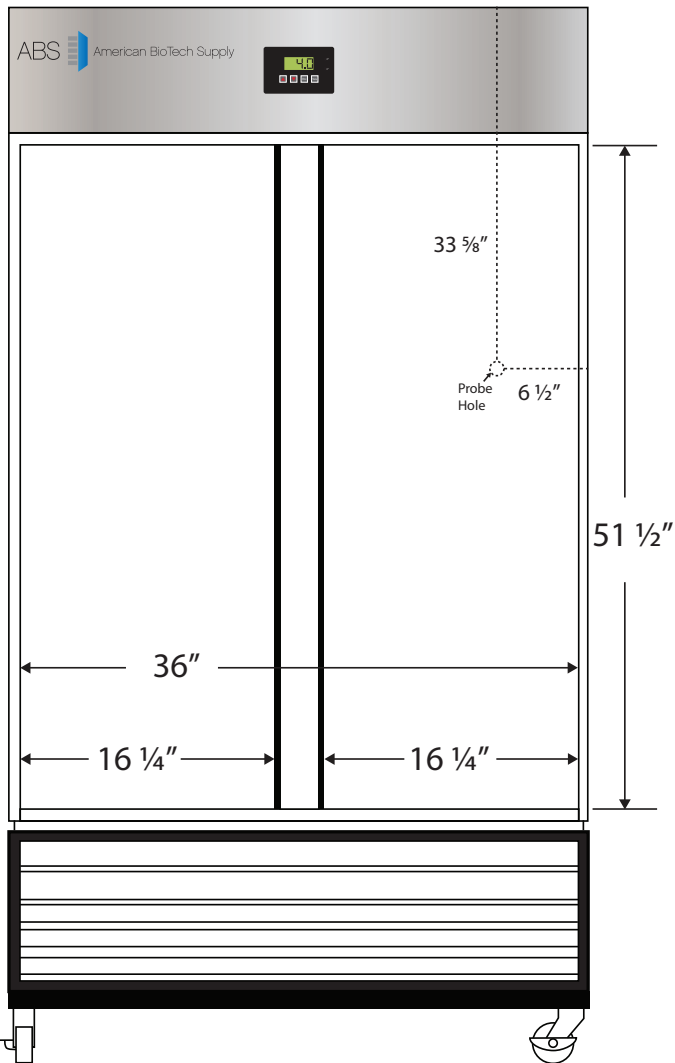

Side View

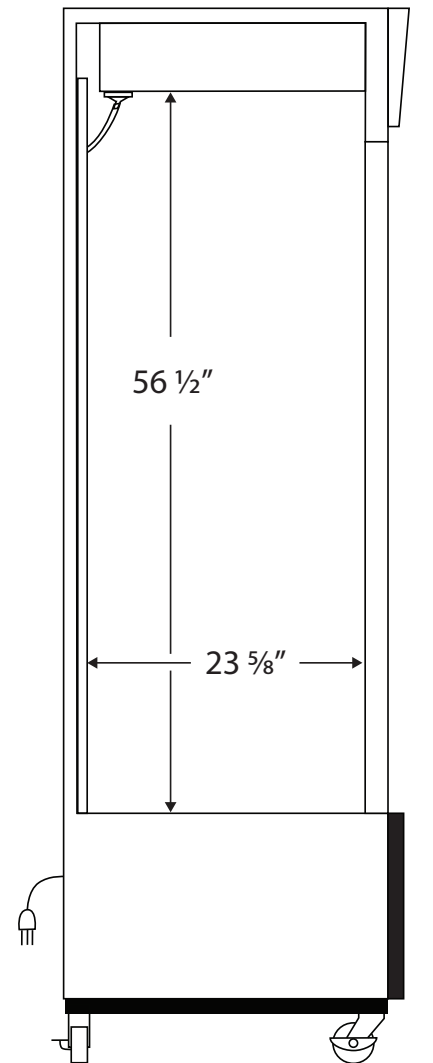

Cu. Ft	Defrost	Door	Int Door	Shelves	Interior Dim.			Refrigerant	H.P.	Amps	Weight
					W"	D"	H"				
35	Cycle	2 Glass	0	8 Adj	36	23 5/8	56 1/2	R290	1/3	6.2	357 lbs.

Note: Interior dimensions are estimates and subject to change without notice