

CUTSHEET

Front View

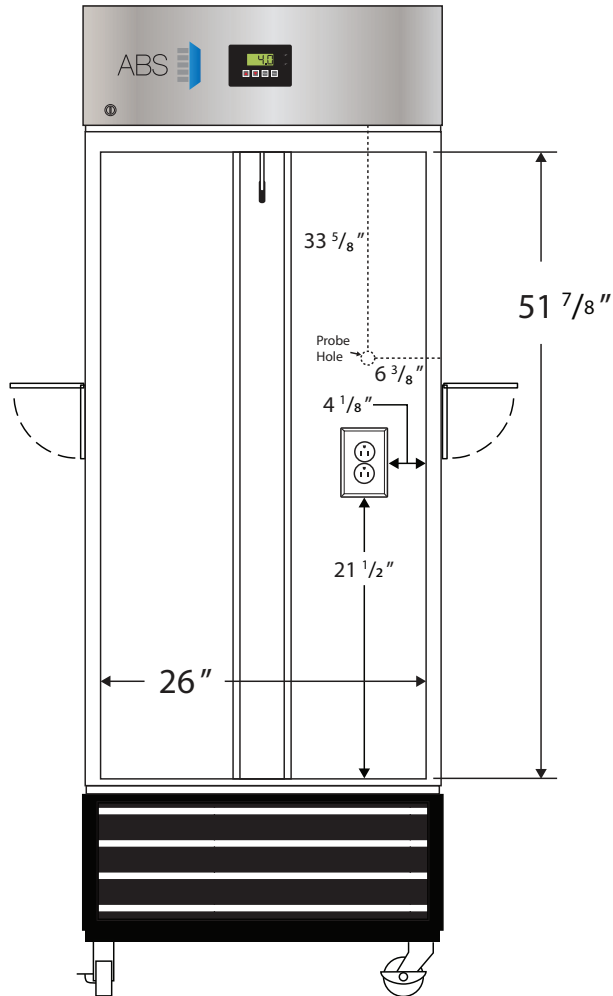

Side View

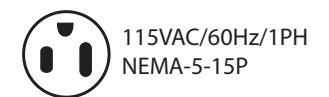
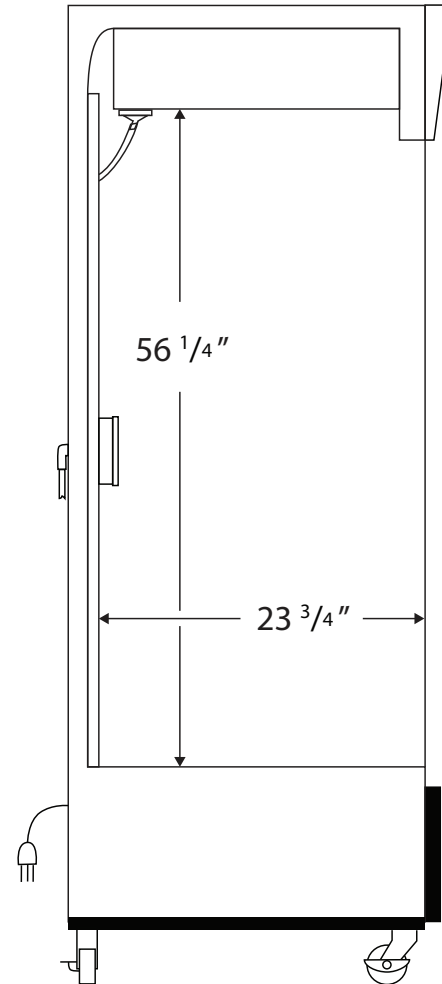

Cu. Ft	Defrost	Door	Int Door	Shelves	Interior Dim.			Refrigerant	H.P.	Amps	Weight
					W"	D"	H"				
26	Cycle	1 Glass	0	4 Adj	26	23 3/4	56 1/4	R290	1/3	5.4	305 lbs.

Note: Interior dimensions are estimates and subject to change without notice