

CUTSHEET

Front View

Side View

Top View

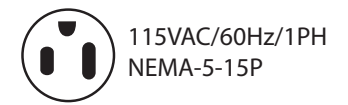
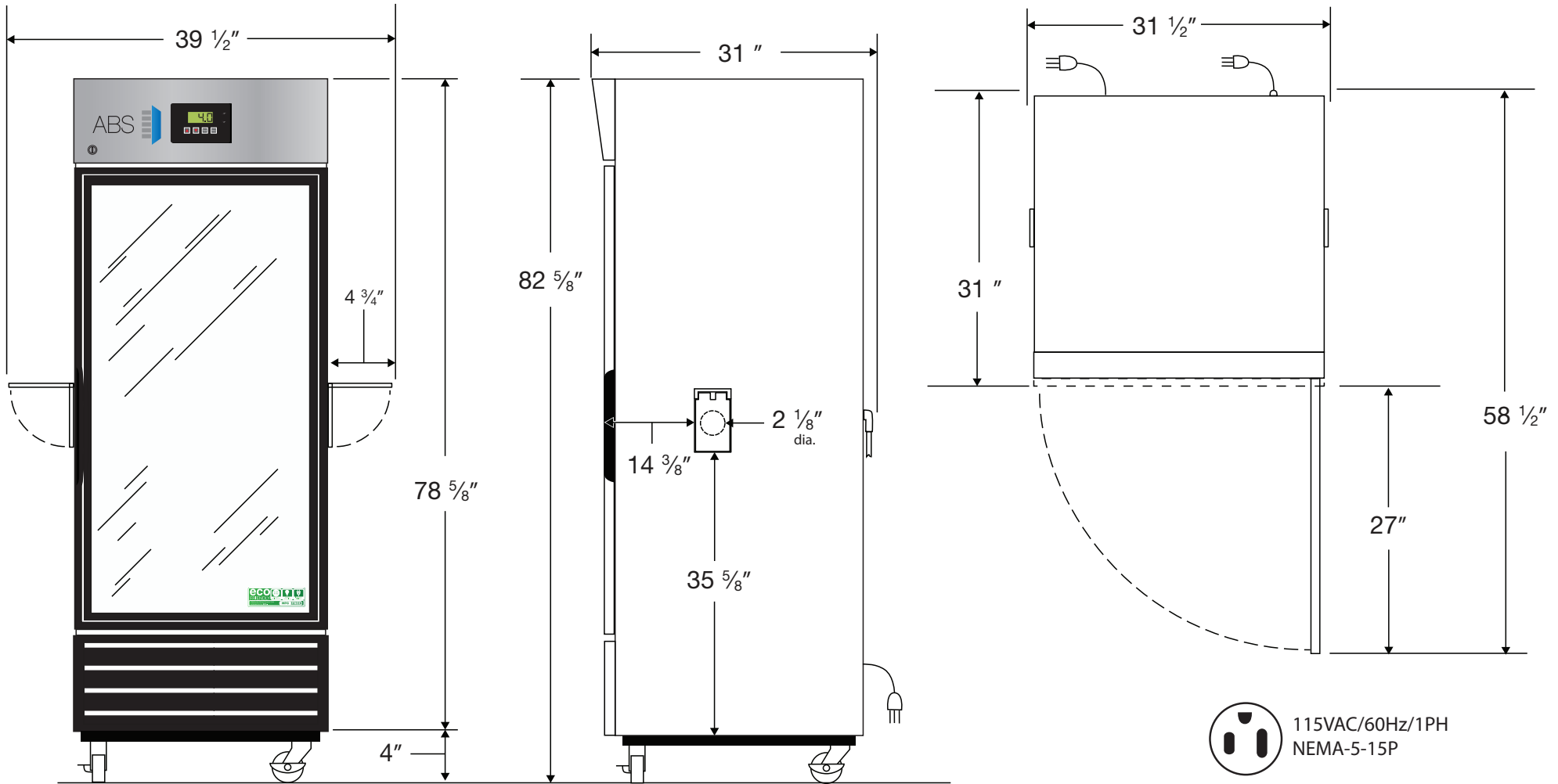

Cu. Ft	Defrost	Door	Int Door	Shelves	W"	D"	H"	Refrigerant	H.P.	Amps	Weight
26	Cycle	1 Glass	0	4 Adj	31 1/2	31	82 5/8	R290	1/3	5.4	305 lbs.