

CUTSHEET

Front View

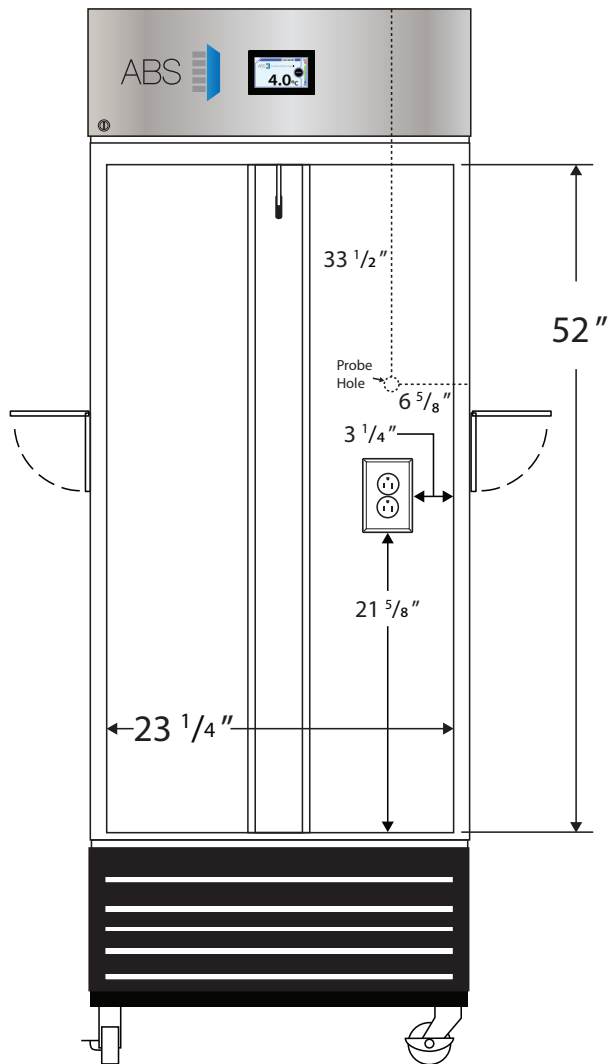

Side View

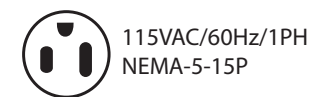
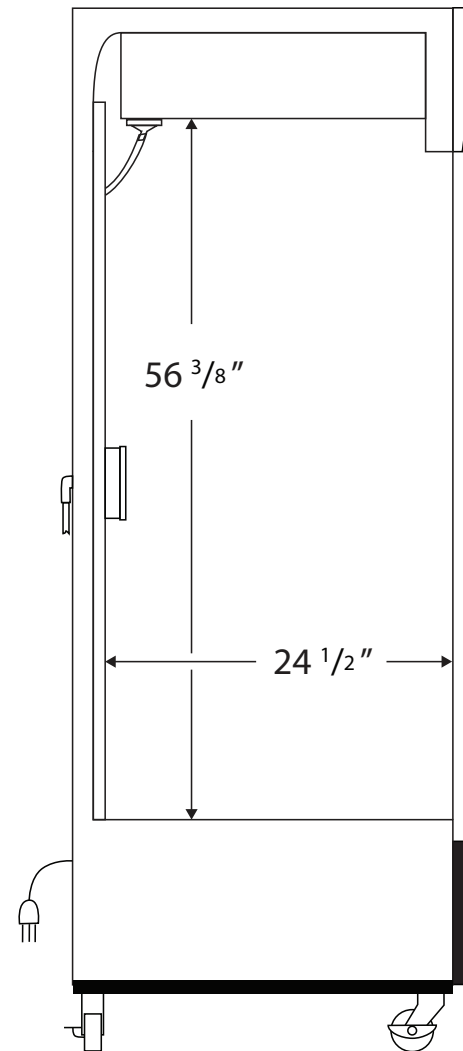

Cu. Ft	Defrost	Door	Int Door	Shelves	Interior Dim.			Refrigerant	H.P.	Amps	Weight
					W"	D"	H"				
23	Cycle	1 Glass	0	4 Adj	24 1/4	24 1/2	56 3/8	R290	1/3	5.4	335 lbs.

Note: Interior dimensions are estimates and subject to change without notice