

CUTSHEET

Front View

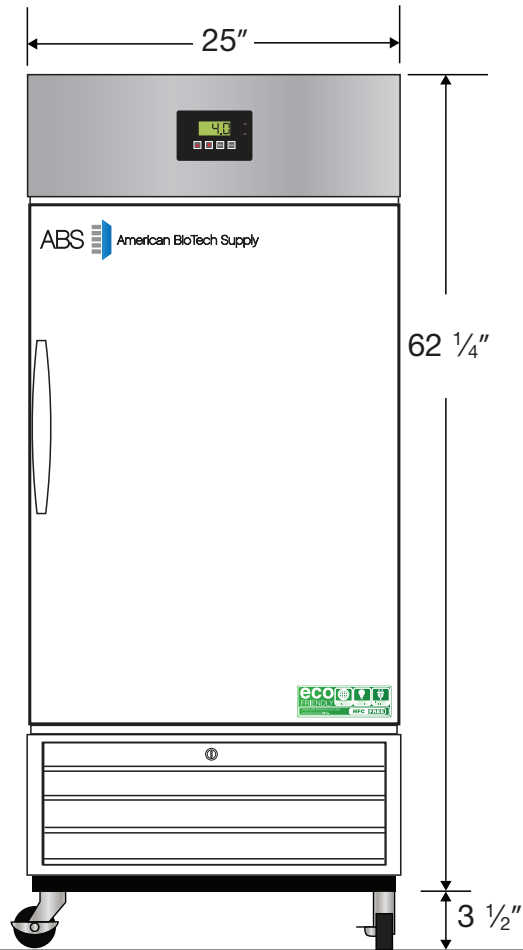

Side View

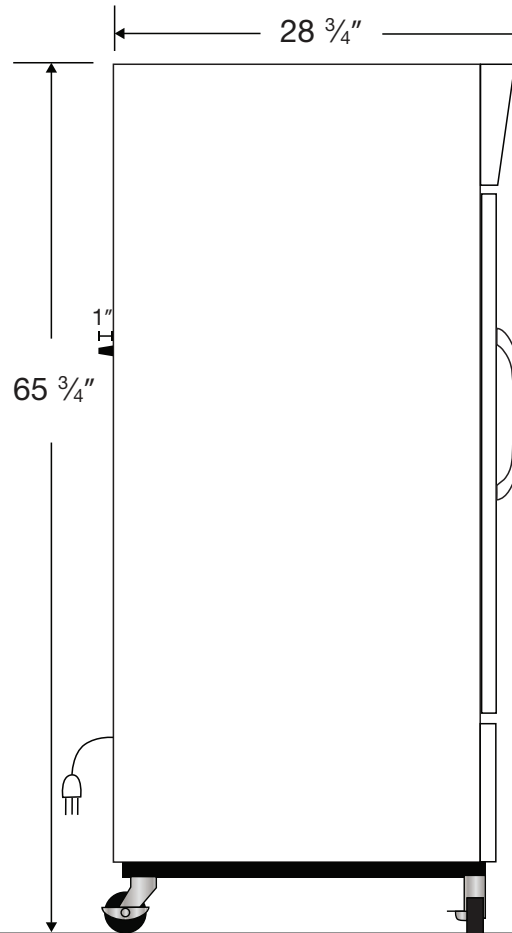

Top View

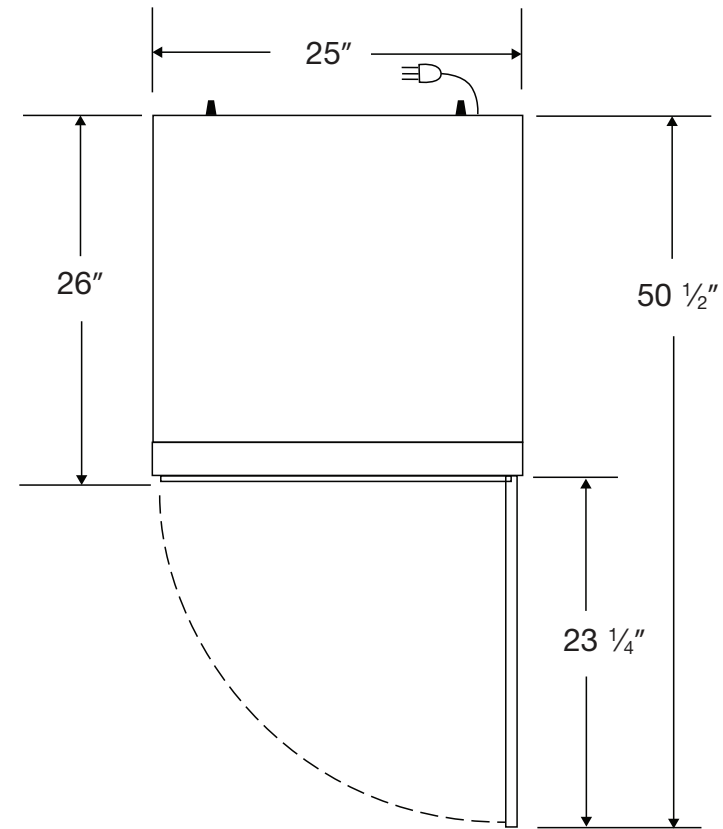

115VAC/60Hz/1PH
NEMA-5-15P

Cu. Ft	Defrost	Door	Int Door	Shelves	W"	D"	H"	Refrigerant	H.P.	Amps	Weight
12	Cycle	1 Solid	0	3 Adj.	25	29 3/4	65 3/4	R290	1/5	3	187 lbs.