

CUTSHEET

Front View

Side View

Top View

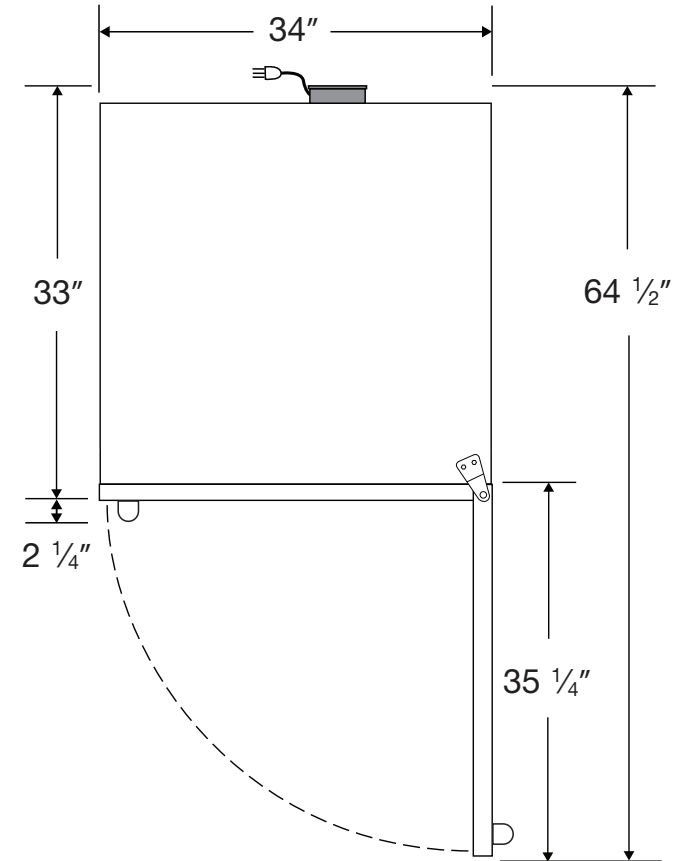
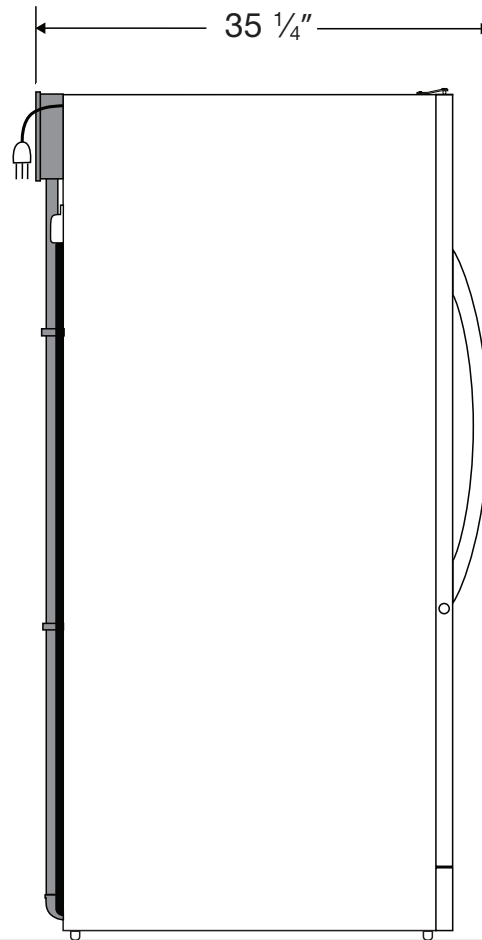
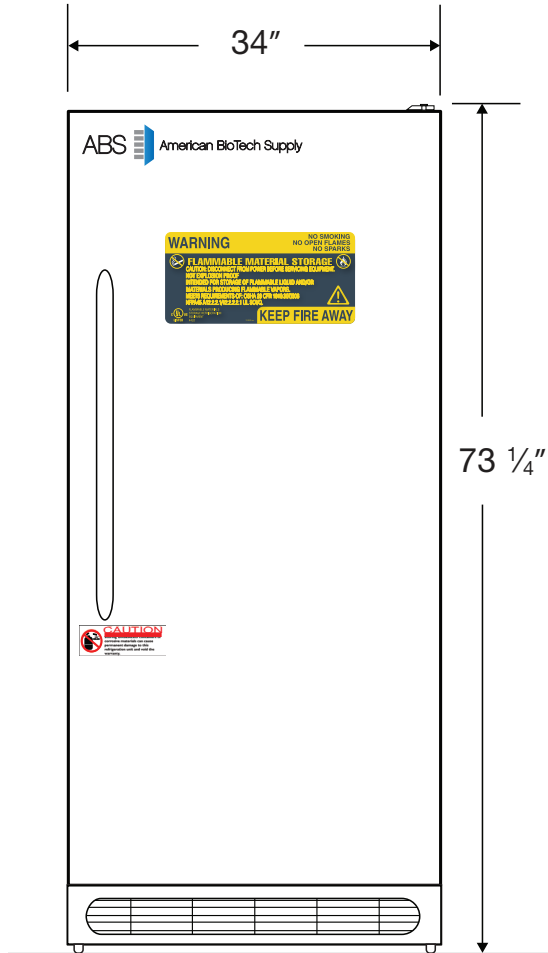

115VAC/60Hz/1PH
NEMA-5-15P

Cu. Ft	Defrost	Door	Int Door	Shelves	W"	D"	H"	Refrigerant	H.P.	Amps	Weight
20	Cycle	1 Solid	0	1 Adj/3 Fixed	34	35 1/4	73 1/4	R134a	1/3	5	256 lbs.