

CUTSHEET

Front View

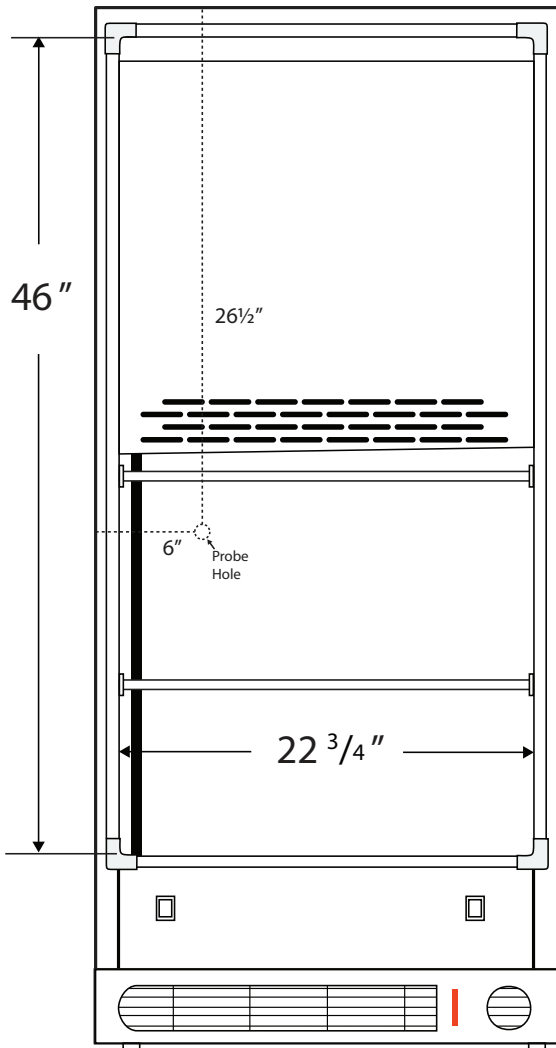

Side View

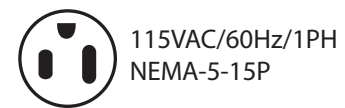
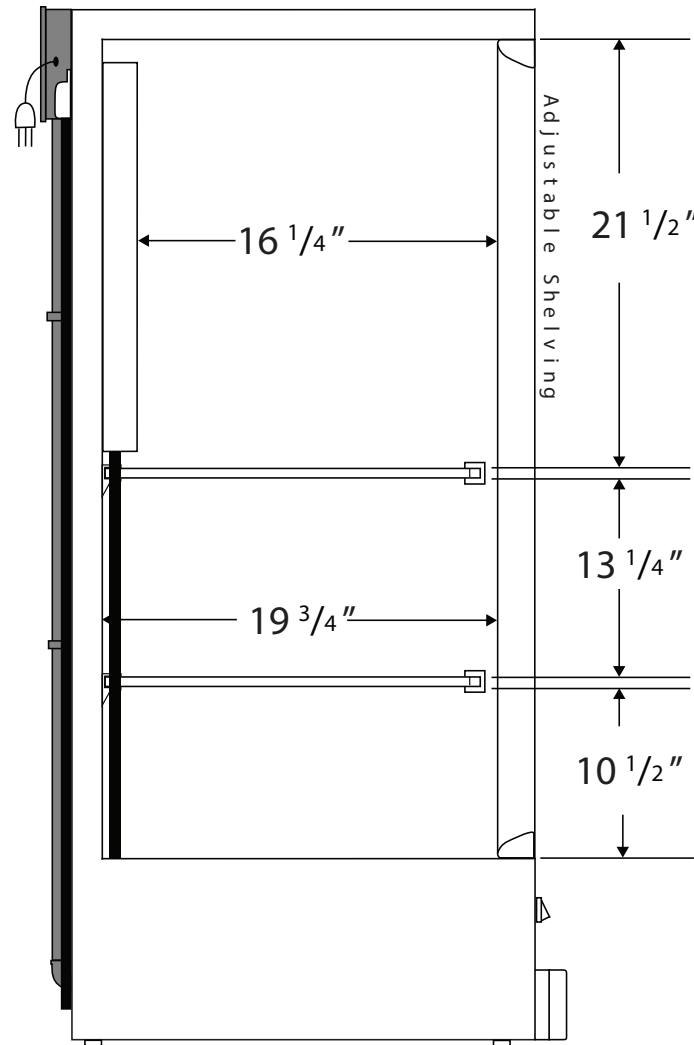

Cu. Ft	Defrost	Door	Int Door	Shelves	Interior Dim.			Refrigerant	H.P.	Amps	Weight
					W"	D"	H"				
14	Cycle	1 Solid	0	1 Adj/2 Fixed	22 3/4	19 3/4	46	R134a	1/3	5	176 lbs.

Note: Interior dimensions are estimates and subject to change without notice