

CUTSHEET

Front View

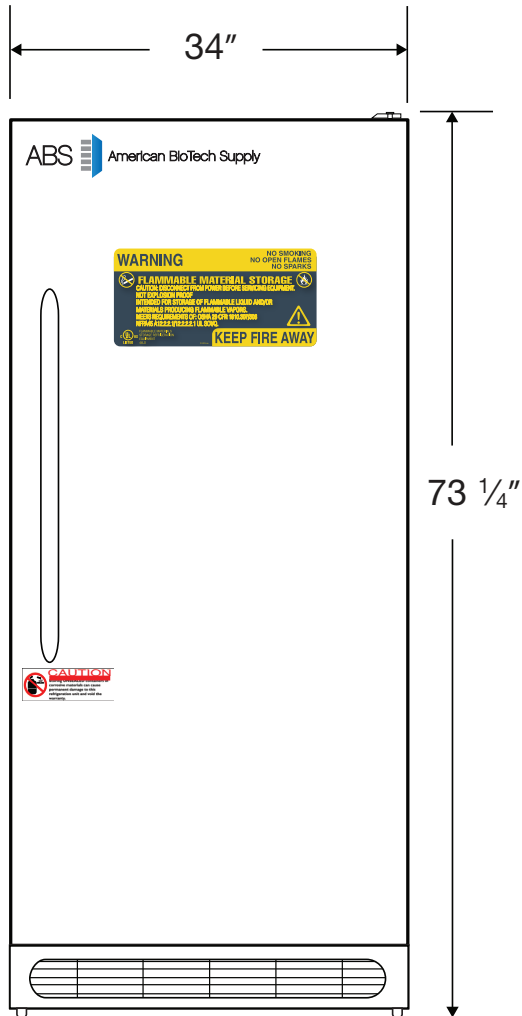

Side View

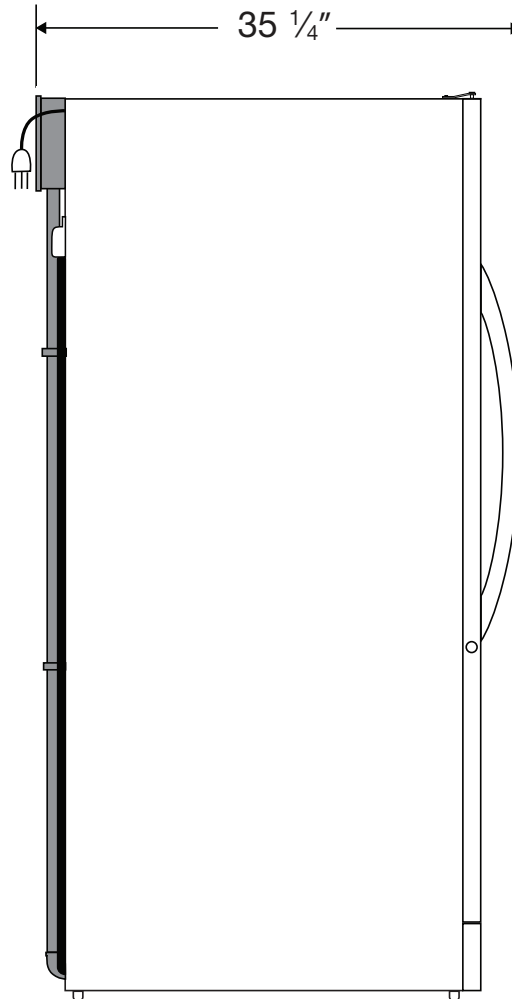

Top View

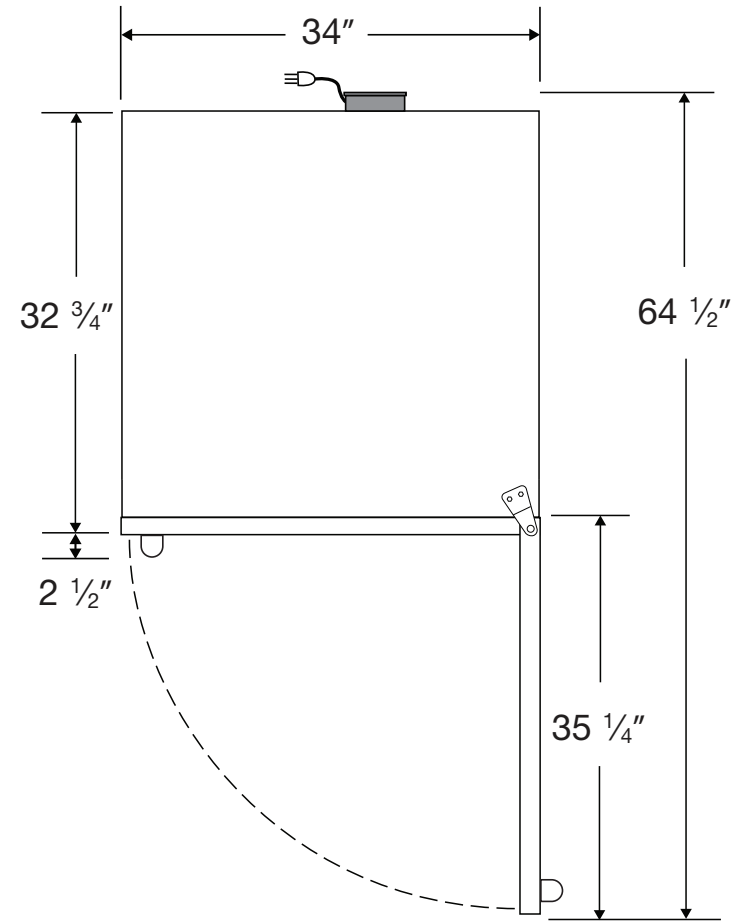

115VAC/60Hz/1PH
NEMA-5-15P

Cu. Ft	Defrost	Door	Int Door	Shelves	W"	D"	H"	Refrigerant	H.P.	Amps	Weight
20	Manual	1 Solid	0	4 Fixed	34	35 1/4	73 1/4	R134a	1/3	5	253 lbs.