



PureAire Dual O₂ / CO₂ Monitor

Instruction Manual

Part Number 99143, 99144
Oxygen range 0-25%
CO₂ range 0-50,000ppm



1140 Ensell Road
Lake Zurich, Illinois 60047
Phone: 847-726-6000
Fax: 847-726-6051
Toll-Free: 888-788-8050
pureairemonitoring.com
Rev 4.10 September 2022

Welcome to PureAire Monitoring Systems

I would like to thank you for investing in our continuous life safety and process control toxic gas monitoring systems.

PureAire offers an unbeatable combination of experience and innovation in solving the safety and environmental needs of our customers. We can provide small systems of a few points to a total multi-point turnkey computerized package.

PureAire's proprietary sensor cell technology and state-of-the-art electronics are designed to interface with the latest distributive or PLC based control systems. We believe that our experience, innovative products, and commitment to service will satisfy your specific monitoring needs now and in the future.

Our growth is a result of our total commitment to supporting our customers. We are available 24 hours a day, 7 days a week to help you when you need us. Our 24 hour Emergency phone number is 1-847-420-3814. We can provide field service, preventative maintenance programs and training to your technicians in the operation of our equipment. Our goal is to provide the best after sale service and support in the industry. That is just one way PureAire takes that extra step to ensure your complete satisfaction.

Thank you again for investing in PureAire Monitoring Systems for your monitoring needs and I am proud to welcome you to our family of valued and satisfied customers.

Sincerely,

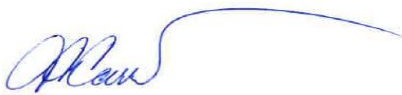

**Albert A. Carrino
President**

Please Read Before Installation

The following will damage the Air Check Oxygen monitor.

1. The Dual O₂/CO₂ monitor requires **24 VDC regulated power**. **Please Do Not connect** the monitor to any voltage that exceeds 24 Volts DC, or **Any AC Voltage**.
2. Do not power the Dual with the oxygen sensor or carbon dioxide sensor unplugged from the main PC board. **Do Not Connect** the O₂ or CO₂ sensor to the PC board while the monitor is powered. This Will Damage the sensors.
3. The oxygen sensor cell is matched to the electronics. **Never exchange** the electronics with an oxygen sensor from a different monitor.
4. When calibrating or challenging the Dual O₂/CO₂ monitors,
 - a. Do not expose the monitor to flow rates that exceed ½ liter per minute, (500 cc per minute) flow.
 - b. Expose the monitor to span gas blends that consist of Oxygen, Nitrogen or Carbon Dioxide only. **Do Not expose the monitor to any combustible gas**, i.e., Methane, Hydrogen, etc. Exposure to combustible span gases can damage the oxygen zirconium sensor cell.
5. Do not expose the Dual O₂/CO₂ monitor to silicone compounds. They can cause a loss of sensitivity.
6. Do not expose the monitor to high flow air or install it directly in front of fans. The high air flow can cool the oxygen sensor and cause an inaccurate reading.
7. When using the Dual O₂/CO₂ monitor, do not expose the oxygen sensor directly to a water stream. In areas requiring wash downs, cover and protect the monitor and power supply. Contact PureAire for details on a waterproof enclosure.
8. Please refer to section 6.3 of this manual regarding the CO₂ sensor. **YOU MUST** choose a calibration method before use.

Table of Contents

1: Introduction	4
1.1 Key Features	4
1.2 Component identification	6
2: Specifications.....	11
2.1 Performance Specifications	11
2.2 Gas Detection System.....	11
2.3 Signal Outputs	12
2.4 Electrical Requirements.....	12
2.5 Physical Characteristics	12
2.6 System Default Factory Settings	13
3: Installation	14
3.1 Site Requirements	14
3.2 Mounting.....	14
3.3 Wiring	15
3.4 Initial Startup	16
4: Normal Operation	17
4.1 Signal Outputs	17
4.2 Instrument Faults	17
4.3 Routine Maintenance Schedule	18
4.4 Loss of Power Indicator.....	18
4.5 Alarm Reset	18
5: Dual O ₂ /CO ₂ Monitor Programming.....	20
5.1 Joystick Operation	20
5.2 Program Flowchart	21
5.3 Entering the Password	25
5.4 Changing the User Password	26
5.5 Entering the Menus.....	29
5.5.1 Set 4-20mA Loop	29
5.5.2 Set Formats	31
5.5.3 Set Alarm Threshold Polarity	34
5.5.4 Set Latching	35
5.5.5 Resetting a Latching Alarm	37
5.5.6 Set Alarm Delay	37
5.5.7 Set Zero Suppression	38
5.5.8 Set Alarm Thresholds	38
5.5.9 Set Alarm Hysteresis	40
5.5.10 Set Sensor Adjust.....	41
5.5.11 Auto Calibrate.....	42
5.5.12 Main Operation Mode.....	43
6: Maintenance & Cell Verification	44
6.1 Sensor Verification, O ₂	44
6.2 Sensor Verification Procedure, O ₂	45
6.3 Sensor Calibration, CO ₂	48
7: Appendix	50

1: Introduction

The **Dual O₂/CO₂** Monitor is a compact gas monitoring system that is ideal for the continuous monitoring of inert gas storage areas, confined spaces, and other locations where low oxygen levels may pose a hazard to personnel. Unlike electrochemical sensor cells the **Dual O₂/CO₂** zirconium oxygen cell and patented NDIR CO₂ cell provides stable readings even in areas where temperature and humidity levels are changing. The PureAire **Dual O₂/CO₂** Monitor is suitable for either indoor or outdoor use. Factory calibrated against a NIST traceable reference standard and Ce approved.

The heart of the monitoring system is a long lasting zirconium sensor for oxygen and NDIR self-calibrating carbon dioxide sensor. The oxygen cell responds to low oxygen conditions within seconds and provides accurate measurements over a wide temperature and humidity range. The zirconium O₂ sensor cell will operate continuously for 10 or more years and requires an absolute minimum of maintenance. There are no zero or span calibration pots to adjust and when compared to disposable type sensors, our long life zirconium O₂ sensor can save up to hundreds of dollars in annual maintenance.

Ideal for continuously monitoring oxygen levels in confined spaces or areas where inert gases are used, the **Dual O₂/CO₂** Monitor does not drift or lose sensitivity when the weather or temperature changes. The electronics are housed in a Nema 3 housing.

Each system consists of a long life zirconium oxide sensor cell and three-wire transmitter. The **Dual O₂/CO₂** monitor may be used as a stand-alone gas detector, linked to optional PureAire single and multipoint controllers, or connected to your own centralized control and surveillance system. This manual covers the installation, operation, and maintenance of the **Dual O₂/CO₂** monitor.

1.1 Key Features

The **Dual O₂/CO₂** monitor incorporates several user-friendly features designed to simplify installation, operation, and maintenance.

1.1.1 Long Life Zirconium Oxide O₂ Sensor

The system's O₂ sensor cell has a life of well over 10 years of continuous operation. Unlike concentration O₂ cells, PureAire's exclusive zirconium oxide sensor cell does not need an oxygen reference gas for proper operation. The **Dual O₂/CO₂** monitor can detect low oxygen levels in confined spaces and process tools without the need of a reference gas.

1.1.2 NDIR CO₂ IR sensor

The system's CO₂ sensor cell is a patented Non Dispersive Infrared, (NDIR) cell designed to detect continuous levels of CO₂. It is fast responding and has a built-in auto calibration feature that adjusts the sensor to ambient every 180 hours.

1.1.3 Smart Electronics

The *Dual O₂/CO₂* monitor incorporates a special electronic circuit that continuously monitors sensor operation. With the addition of the alarm relay option, any cell degradation or complete failure will immediately be detected. This smart circuitry alerts the user to sensor faults and other electrical problems that may interrupt surveillance through the standard mA output signal or through the optional fault relay option.

1.1.4 Calibration O₂

The *Dual O₂/CO₂* monitor incorporates a stable zirconium oxide sensor that rarely requires calibration. Changing barometric pressure changes or changes in temperature and humidity do not affect the zirconium oxide oxygen cell. The earth is a wonderful source of calibrated oxygen at 20.9% therefore under ambient conditions verification of the *Dual O₂/CO₂* monitor to 20.9% oxygen is constantly being performed. There are no zero or span pots to adjust. The O₂ monitor only requires periodic testing with nitrogen to verify the cells response to low oxygen levels. See Section 6.2 for the testing procedure to nitrogen.

1.1.5 Calibration CO₂

The *Dual O₂/CO₂* monitor incorporates an NDIR CO₂ sensor that provides an accurate reading that is the difference between a reference baseline setting and the measured gas concentration. The sensor is factory calibrated and requires no user calibration but as typical with most NDIR sensors, long term drift can affect the baseline setting. Under normal conditions, the sensor provides automatic baseline adjustments, and no further action is required by the user. However, under certain conditions, manual adjustments may be required. See Section 6.3 for further explanation and procedures for adjusting the baseline setting.

1.2 Component Identification

1.2.1 Front View Exterior

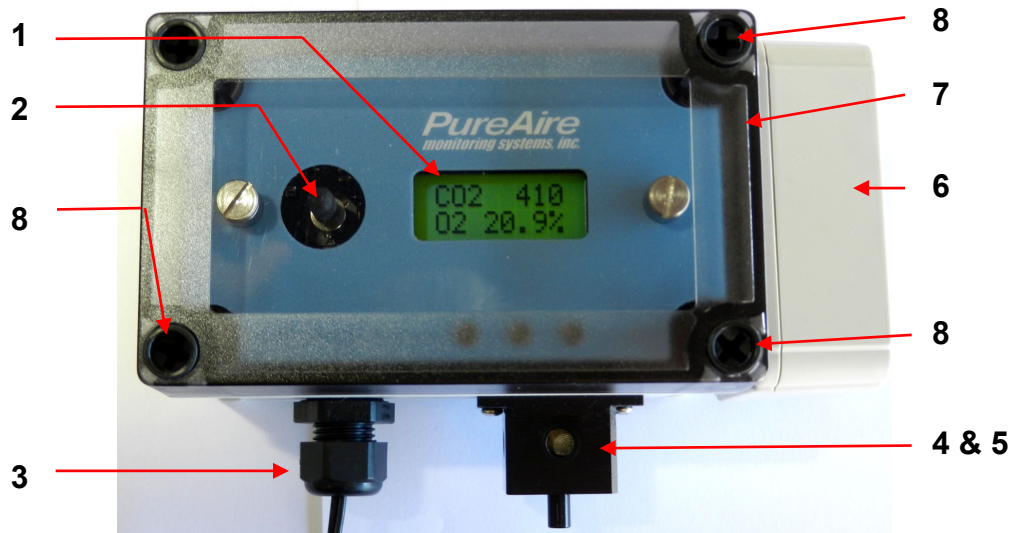

1. **Digital Display** — 3-digit backlit LCD digital display for showing the oxygen levels in percent.
2. **Joystick** — Used for selecting and adjusting the built-in menus.
3. **Cable Port** — This is the opening in the transmitter housing for connecting the 4-20 mA output and 24 VDC power cable.
4. **Sensor Protector**—The O₂ sensor is heated, and the sensor protector shields the cell as well as provides airflow to the cell.
NOTE: The sensor protector will feel HOT to the touch. This is normal.
5. **Oxygen Sensor** — A zirconium oxide sensor, which detects and measures the level of oxygen.
6. **CO₂ Sensor**— A NDIR sensor housed inside the cell protector.
7. **Transmitter Cover** — A removable cover that protects the interior of the transmitter.
8. **Transmitter Cover Fasteners** — There are 4 captive screws secure the transmitter cover in place.
9. **Electronics Fasteners** — These captive screws secure the electronics to the enclosure
10. **Mounting Feet** — There are 4 feet used to mount the oxygen monitor to a wall or other flat surface.

1.2.2 Front View Exterior with Relay Option

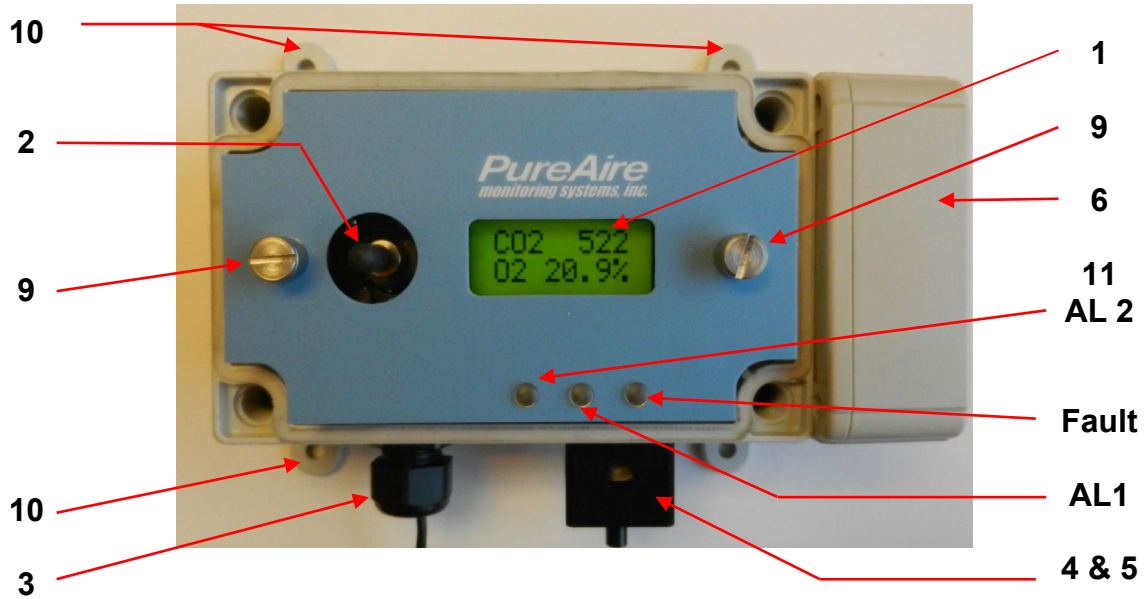

11. Alarm Indicators — 3 multicolored LED indicators for showing:

- | | |
|--------------------------------|------------|
| Alarm level 1, CO ₂ | Orange LED |
| Alarm level 2, O ₂ | Red LED |
| Fault Alarm | Yellow LED |

1.2.3 Side View Exterior with Audio Alarm

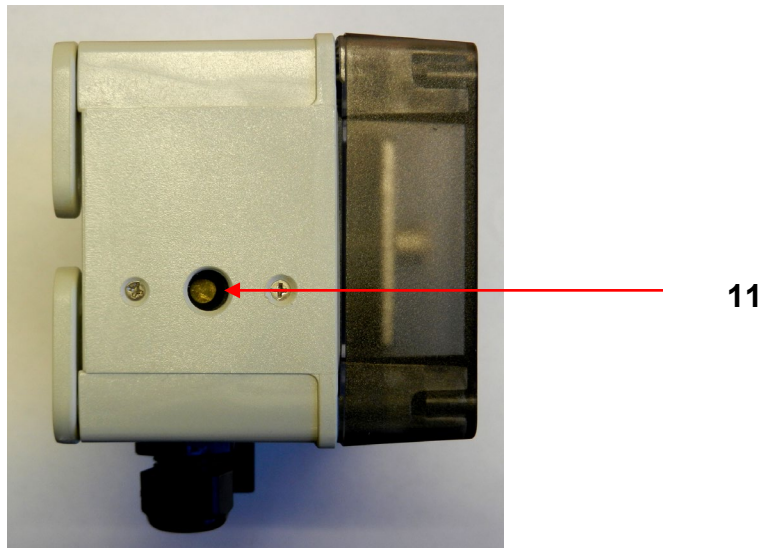

11. Audio Horn — This built-in horn is a 90dB high pitched audio sound will activate when either oxygen levels go below the selected alarm thresholds or CO₂ levels go above the selected alarm threshold. The audio alarm is non-latching and will automatically turn off when the alarm condition clears.

NOTE: The audio alarm is an immediate alarm. Alarm levels must recover to safe levels before the horn turns off. There is no audible alarm delay function available.

1.2.4 Side view of the CO₂ Sensor

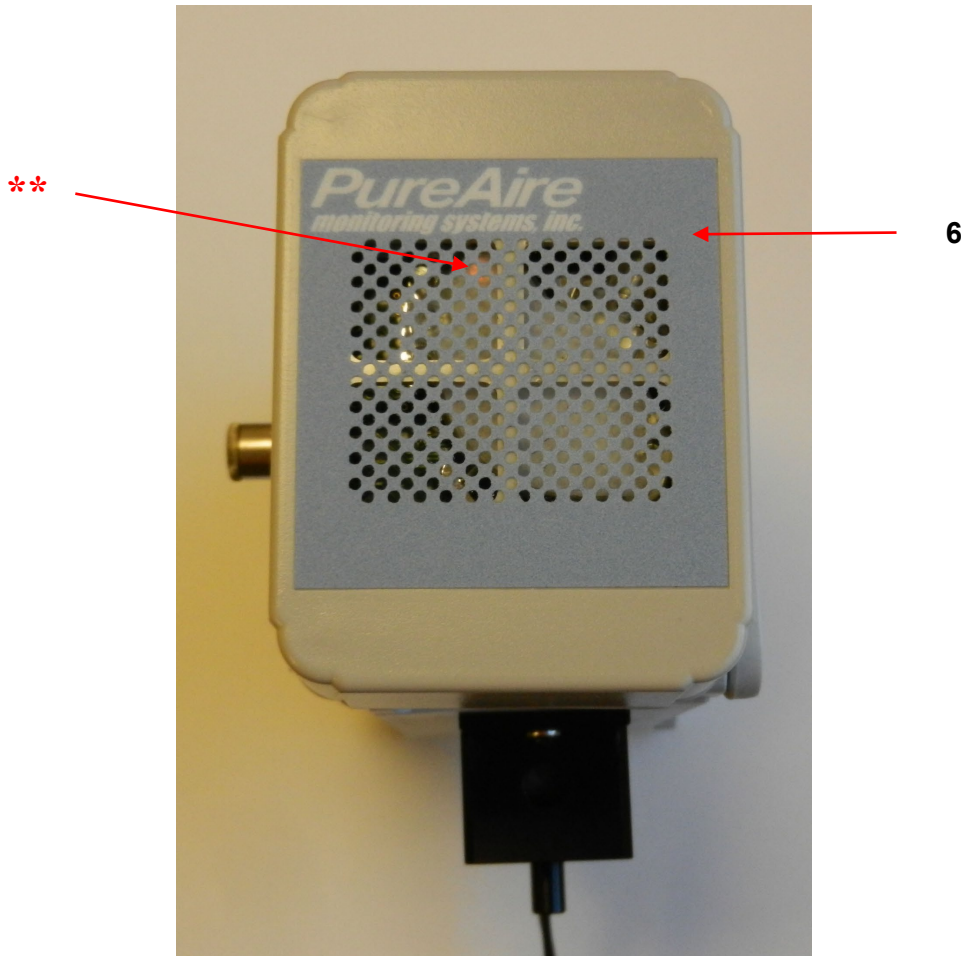

****NOTE:** The CO₂ sensor is an NDIR type that is continuously monitoring ambient levels. You will see a blinking orange LED flash approximately every 2 seconds. This is normal.

NOTE: The CO₂ sensor and sensor cable are hard wired directly to the main board.

1.2.5 Transmitter Interior

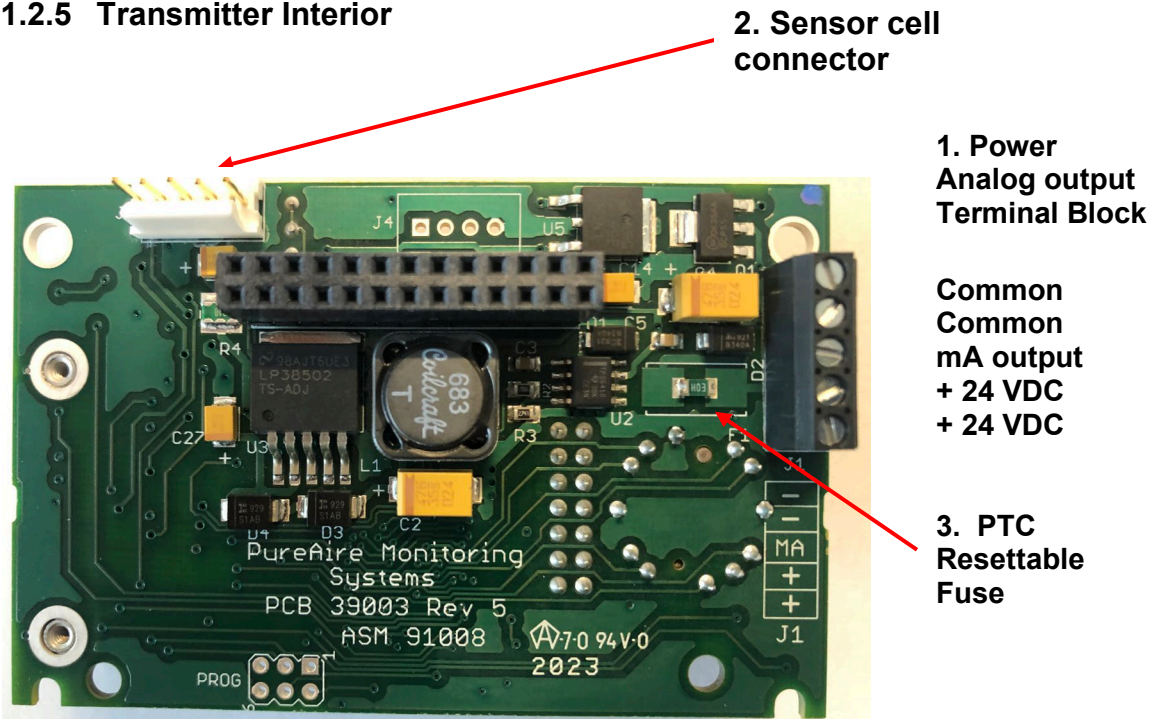

2. Sensor cell connector

1. Power Analog output Terminal Block

Common
Common
mA output
+ 24 VDC
+ 24 VDC

3. PTC Resettable Fuse

1. **Power Analog Terminal Block** — This terminal block is where the 24VDC power and 4-20 mA analog output connection is made.
2. **Sensor Cell Connector** — This connector is where the Oxygen sensor cell is connected. **NOTE: Never connect the oxygen sensor to this connector while the monitor is powered. This will damage the oxygen sensor**
3. **PTC Resettable Fuse** — The PCB is protected with a PTC Fuse that is resettable and Never needs to be replaced. If it trips, you will need to turn power off to the monitor. When power resumes the fuse will reset.

1.2.7 Alarm Relay Board

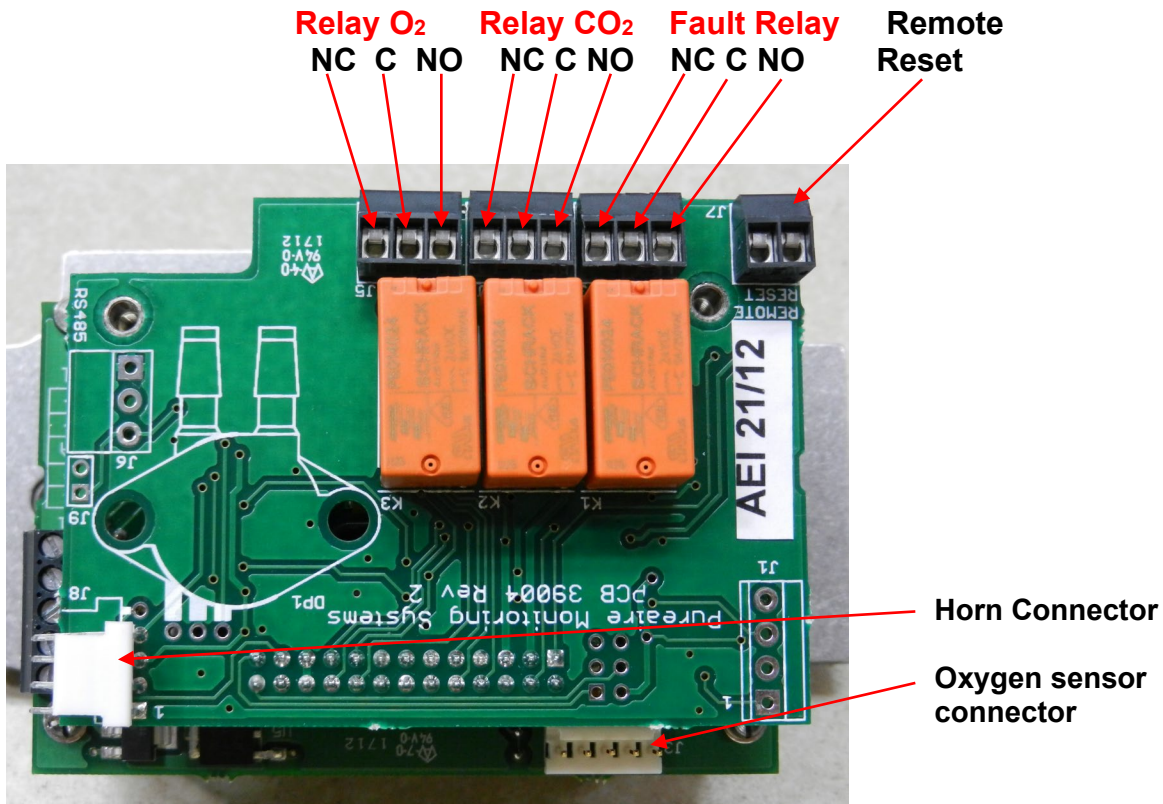

1.2.8 Enclosure Mounting Feet



Mounting Feet can be oriented in any direction

Feet can also be removed for mounting the Dual O₂/CO₂ monitor flush with a wall or other surface

2: Specifications

NOTE: For our continual product improvement, all specifications are subject to change without notice.

2.1 Performance Specifications Oxygen sensor

Sensor Type:	Long Life Zirconium Oxide Sensor Cell 0-25%
Response Time:	Within 1 second of any change in O ₂ .
Accuracy:	± 1% of full scale
Fault Indicators:	Loss of VDC power (analog signal drops to 0 mA). Sensor cell failure: Fault relay activated. (Must have Alarm relay option for cell failure to operate)
Operating Temp:	-40° to 134°F (-40° to +55°C); consult PureAire for lower or higher operating temperatures.
Humidity:	0 to 95% RH; consult PureAire for sensors which can operate in 100% condensing RH environments.
Environment:	Max. Altitude 2000 m, Pollution Degree 3, Intended for Indoor Use.
CE	EN 61000-3-2:2006 EMC, EN 61000-3-3:2008 EMC, EN61010-1-3-2013 LVD

2.2 Performance Specifications Carbon Dioxide sensor

Sensor Type:	Long Life NDIR Sensor 0-50,000ppm
Response Time:	Within 1 second of any change in CO ₂ .
Accuracy:	±300 ppm, ± 3% of measured value.
Fault Indicators:	Loss of VDC power (analog signal drops to 0 mA). Sensor cell failure: Fault relay activated. (Must have Alarm relay option for cell failure to operate)
Operating Temp:	32° to 122°F (0° to +50°C); consult PureAire for lower or higher operating temperatures.
Humidity:	0 to 95% RH.
Environment:	Altitude 2000 m, PSU only UL spec. Pollution Degree 3, Intended for Indoor Use.
CE	EN 61000-3-2:2006 EMC, EN 61000-3-3:2008 EMC, EN61010-1-3-2013 LVD

2.3 Gas Detection System

Transmitter:	Microprocessor electronics with built-in 3-digit backlit LCD display Joystick operated menus
--------------	---

2.3 Signal Outputs

Local Display: Digital display calibrated for Oxygen and Carbon Dioxide. The range is stated on the model label and can also be accessed via the joystick on the front panel. In the measurement mode pushing the joystick down will scroll the gas and range on the display. Push the joystick down again to stop the scrolling and display the gas again.

Standard Analog Output: DC 4-20 mA

Relay Output: Dual level user selectable alarm relays and one fault relay
Rated, 2amps @ 24VAC or 24VDC

2.4 Electrical Requirements

Power: 24 VDC external power. A regulated 24VDC power supply is required.

Consumption: Approximately 250mA

2.5 Physical Characteristics

Dimensions: 6.5 (W) x 3.15 (H) x 3.00 (D) inches; 165 x 80 x 76 mm (Max with feet)

Weight: 1.1 pounds (0.5 kg)

Enclosure Type: General purpose; not intended for explosive atmospheres.

2.6 Dual O₂/CO₂ System Default Factory settings

The *Dual O₂/CO₂* Monitor is shipped with factory defaults for the alarm relay settings. The following are the factory defaults:

Menu Function	Factory Default	Menu Defined
Set 4-20mA loop	The mA output is set at the factory using a calibrated Fluke meter.	Use this function to adjust the monitor's 4mA, (Zero) and 20mA, (Span) to your PLC or distributive control system.
Set Formats LED and alarm relay State **	Alarm 1 = Normal Alarm 2 = Normal Fault = Normal	Do you want the relays to energize, (normal) or de-energize, (fail safe) when the alarm activates?
Set Alarm Threshold Polarity	Alarm 1 = Normal Alarm 2 = Inverted Audio = Inverted	Do you want to alarm at a level higher, (normal) or lower, (inverted) than the alarm threshold?
Set Latching	Alarm 1 = Non-latching Alarm 2 = Non-latching Audio = Non-latching	Do you want the alarm to automatically reset? (non-latching) or do you want to manually reset the alarm? (latching)
Alarm Delay	Alarm = 5 seconds	How long do you want to wait until the alarms activate?
Zero Suppression	000 = 0.00% Refer to section 4.5.6	This function is Not Enabled on the Dual monitor.
Set Alarm Thresholds	Alarm 1 = 5,000ppm Alarm 2 = 19.5%	At what level do you want to alarm?
Set Alarm Hysteresis	Alarm 1 = 00 PPM Alarm 2 = 0.0 %	For use when using the O ₂ monitor for control of valves and process. See Section 5.4.8
Sensor Adjustment	O ₂ sensor set 20.9% CO ₂ set to autocal <u>on</u>	For use when dynamically gas calibrating the Oxygen and CO ₂ monitor. See Section 6.2
Manage Passwords	Factory default is 557	For use when changing the password from factory default to a new password of your choice.

NOTE: The built in relay settings may be changed by the user in the field. Refer to Section 5.5.2

**** NOTE:** The LED indicators on the front panel are connected directly to the alarm relays.

3: Installation

3.1 Site Requirements

The *Dual O₂/CO₂* monitor enclosure should be mounted in an area free of vibration and electrical noise or interference. If possible, avoid areas with high temperatures or condensing humidity.

The oxygen monitor covers an area of approximately 692 square feet when mounted on a wall and should be placed no more than 21 feet from potential leak sources such as gas lines, gas cylinders, or any areas where a gas leak might be expected to occur.

To ensure safety, the maximum distance between two monitors mounted to the same wall, should **not** exceed 30 feet.

WARNING: The *Dual O₂/CO₂* monitor is not designed for installation in hazardous areas. Consult PureAire for information on enclosures for use in hazardous environments.

3.2 Mounting

3.2.1 Transmitter Enclosure

The *Dual O₂/CO₂* monitor is designed primarily for wall mounting and should be installed at a height convenient for operation, maintenance, and viewing of the instrument display. The following is a drawing of the mounting dimensions.

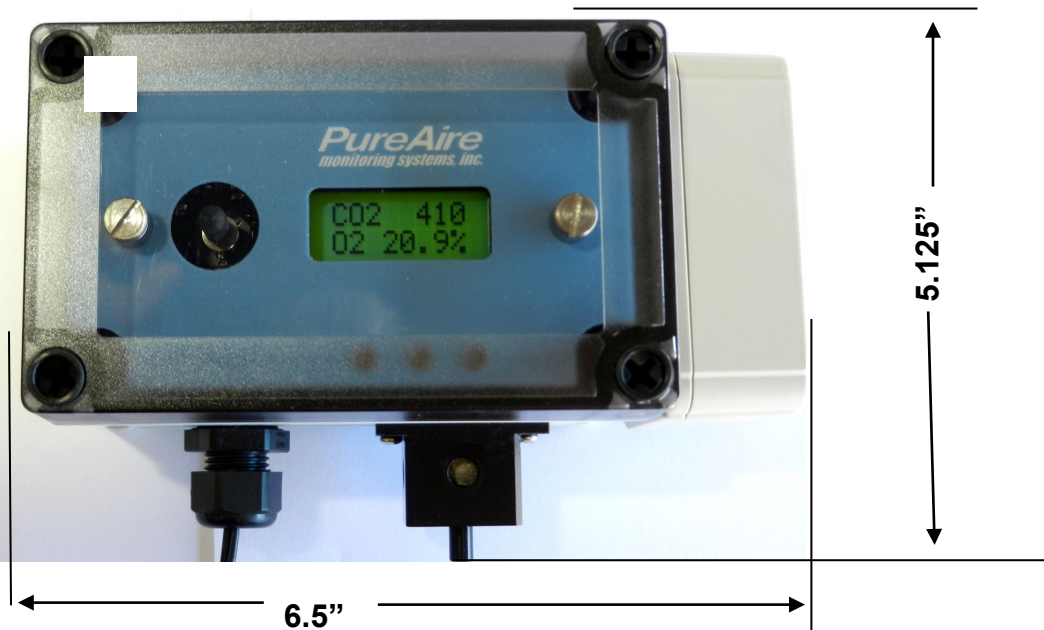

3.2.2 Dual O₂/CO₂ monitor

The transmitter and sensor should be installed in a location where gas leaks are likely to occur or where released gases may accumulate. It should be mounted no closer than 12 inches above floor level. **Airflow within the monitored area, the characteristics of the gas (lighter or heavier than air), and the position of workstations and personnel should all be considered in determining the most suitable installation location.**

3.3 Wiring

The **Dual O2/CO2** monitor requires a single, 3-wire shielded cable for analog output and 24 VDC power input. A three-wire shielded cable; 3-conductor, 18 AWG stranded General Cable E2203S.30.860, or equivalent is recommended for the connection. The analog out and VDC power in connections are made on the terminal block inside the transmitter housing.

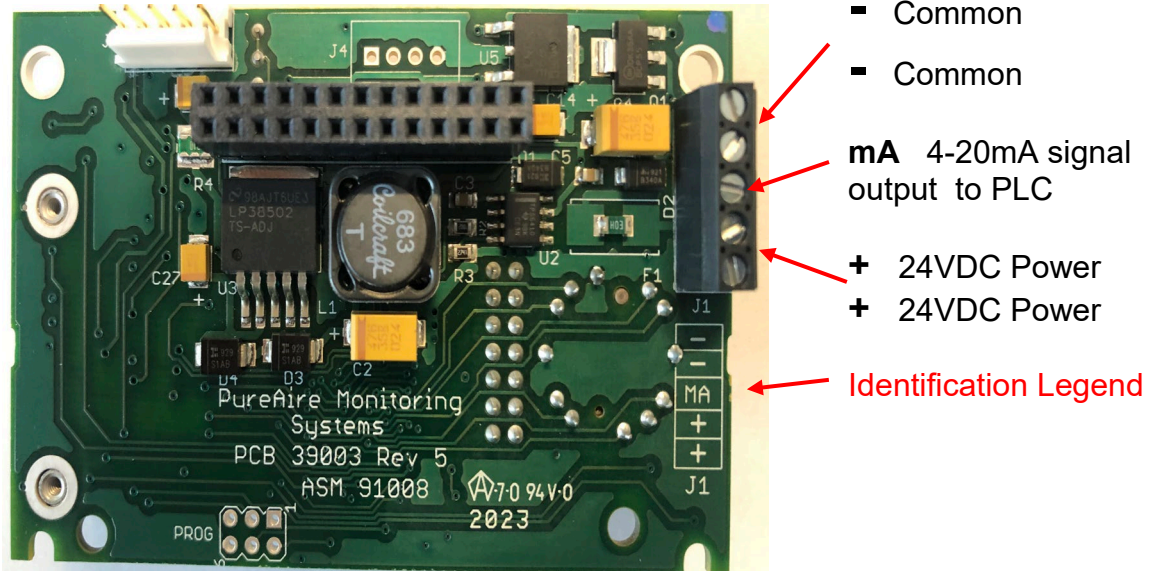

These connections are made as follows:

Pin #	Connection	Description
-	Common (Signal Ground)	0V
-	Common (Signal Ground)	0V
MA	Signal Out	DC 4-20mA Output
+	Power	DC + 24V Input
+	Power	DC + 24V Input

NOTE: *PureAire has added additional contacts for +24VDC power and Common to accommodate additional wiring for remote horns and strobes*

3.4 Initial Startup

Once installation of the gas detector has been completed, it is ready for startup. The following procedures should be performed before putting the instrument into operation:

1. Check the integrity of all wiring.
2. Apply 24 VDC power.

The instrument should now be powered up. Upon power up, the **Dual O₂/CO₂** monitor LCD displays the PureAire logo and then starts a 4-minute, (240 second) count down as the current to the zirconium oxide O₂ sensor stabilizes. The monitor will output a 4 mA signal during the entire warm-up period. After the countdown, the oxygen sensor will continue to reach its operating temperature for approximately 30 minutes and the reading displayed will slowly increase to ambient. **Do not make any adjustments to the reading until after the monitor has been powered for at least an hour.**

NOTE: The **Dual O₂/CO₂** monitor is supplied with an Audio Horn, it will activate momentarily at the completion of the warmup.

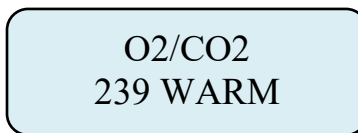

NOTE: The **Dual O₂/CO₂** monitor's oxygen reading may be adjusted to the ambient oxygen Level. The CO₂ sensor has an auto calibration feature. It also may be manually calibrated to span gas. See section 6.1 for instructions on adjusting.

4: Normal Operation

The *Dual O₂/CO₂* monitor is a single point monitor designed for the continuous detection and measurement of ambient oxygen and carbon dioxide concentration levels.

4.1 Signal Outputs

The *Dual O₂/CO₂* monitor outputs a continuous 4-20 mA analog signal proportional to the measured concentration of either oxygen or carbon dioxide. ***The 4-20mA output can only be used for gas.*** When oxygen is selected; 4 mA represents 0% O₂ and 20 mA represents 25% O₂ which is the full range for oxygen. When carbon dioxide is selected; 4mA represents 0ppm and 20mA represents 10,000ppm which is the full range for carbon dioxide. In the event of a system fault, a specific factory defined code will be displayed on the local digital display. This code will indicate the exact nature of the system fault.

4.2 Instrument Faults

The *Dual O₂/CO₂* monitor incorporates a several self-checking features to ensure reliable operation. In the event that a fault condition is detected, the analog output signal is altered: A few common error codes are displayed in the following table:

Condition	Analog Signal
**Supply Voltage Out of Range Fault code 16	Analog output drops to 2 mA Fault Relay activates
Transmitter cable cut	Analog output drops to 0 mA
O ₂ Cell complete failure Fault code 128	Analog output drops to 2 mA
O ₂ / CO ₂ System Warm Up	Analog output drops to 2 mA Fault Relay activates and turns off when system is in the monitoring mode
O ₂ Cell voltage fault Fault Code 64	Analog output drops to 2 mA Fault Relay activates
EEPROM Fault 08	Analog output drops to 2mA Fault Relay activates
CO ₂ sensor not responding Fault code F01	Analog output drops to 2mA Fault Relay activates

NOTE: All system faults are displayed on the front panel. Each fault has it'own specific code to identify the specific problem. Please contact PureAire whenever a fault is displayed.

**** When using your own power supply please ensure that the voltage is regulated to 24VDC +/- 0.5 volts. If the voltage is too low or high you will activate a "Supply Voltage Out of Range fault and disable the monitor.**

4.3 Routine Maintenance Schedule

Continuous gas detection systems depended upon to measure and detect hazardous gas leaks in the workplace requires periodic maintenance to ensure proper operation. The frequency with which this routine maintenance is required depends on the environment. The following table is intended to serve as a general guideline for routine maintenance. The conditions in your particular application, as well as your organization’s maintenance policies, will ultimately determine the best routine maintenance schedule for your equipment. Routine Visual Checks

Items to check	Check for power and proper operation
Condition / status when operating properly	Unit should be outputting a 17.4 mA signal when the oxygen level is at 20.9% or approximately 4.6mA when the carbon dioxide is at ambient 400ppm. The LCD digital display should also indicate 20.9% O ₂ and approximately 405 ppm level when the oxygen and carbon dioxide levels are at ambient.

4.3.2 Recommended Routine Maintenance Schedule

Routine Visual Checks	Every 6 - 12 months
Sensor Verification with nitrogen	Every 6 - 12 months**

** The ambient oxygen level is 20.9%; therefore, under ambient conditions verification of the **Dual O₂/CO₂** monitor to 20.9% oxygen is constantly being performed. The oxygen sensor only requires periodic testing with nitrogen to verify the cells response to low oxygen levels. **See Section 5.5.10 for how to make minor adjustments to the oxygen sensor.**

The ambient CO₂ level is 400ppm and the sensor provides automatic baseline adjustments to ambient levels on a regular time schedule. However, the CO₂ sensor can be manually calibrated by using span gas. See section 6.3 for how to manually calibrate the CO₂ sensor.

4.4 Loss of Power Indicator

In the event the **Dual O₂/CO₂** monitor loses 24VDC power, the 4-20 mA analog output signal drops to 0mA. The LCD display will also display a blank screen.

4.5 Alarm Reset

It the **Dual O₂/CO₂** monitor is supplied with individual alarm relays for each gas. Whenever the monitor’s alarms are activated, the built-in alarm relays, panel mounted LEDs and audio horn will also activate. When the relay settings are non-latching, the alarm relays, LEDs, and horn will automatically reset. If the relay settings are latching, then a manual reset of the alarms are required. Resetting the alarms can be performed through use of the joystick or through the use of the remote reset function.

Joystick – You must enter the password to enter the reset function. After the password is entered and accepted, push the joystick in; (enter) to reset the alarms.

Remote Reset – See section 1.2.7. The alarm relay board has a two-pin connector for wiring to a remote switch. When connected to a switch, this remote reset will bypass the joystick and a password will not be needed to reset the alarms.

NOTE: The oxygen levels must recover above the alarm thresholds before the horn can be reset from the remote reset switch or joystick.

5: Dual O2/CO2 Monitor Programming

The *Dual O2/CO2* monitor is supplied with user selectable settings to adjust the alarm settings, 4 and 20mA output and minor sensor adjustments. The settings are arranged in menus that are accessed by moving the joystick. To access the menus a factory set password is used.

NOTE: The *Dual O2/CO2* monitor will continuously monitor oxygen while accessing the menus. **The alarm, fault relays and mA output are all active and online while making any changes to the menus.**

5.1 Joystick Operation

The *Dual O2/CO2* monitor uses a 4-position joystick with a center pushbutton for selecting menus and changing values. The joystick is programmed to standard protocol as follows:

NOTE: *The joystick has a built-in delay to prevent accidental tampering of the menus. deliberate entries are required.*

CAUTION: *Only qualified personnel should perform programming, maintenance, and sensor verification*

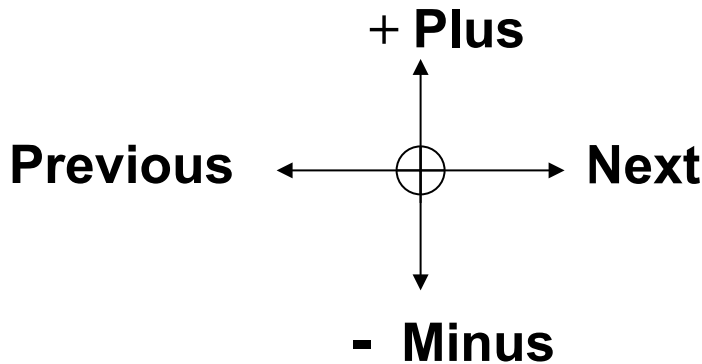

Plus – Pushing the joystick in this direction increases the value

Minus – Pushing the joystick in this direction decreases the value

Next – Pushing the joystick in this direction moves you to the next level of the menu hierarchy.

Previous – Pushing the joystick in this direction takes you out to the last level of menu hierarchy.

Enter – Pushing the joystick directly in the center enters the information into the microprocessor

5.2 Program Flowchart

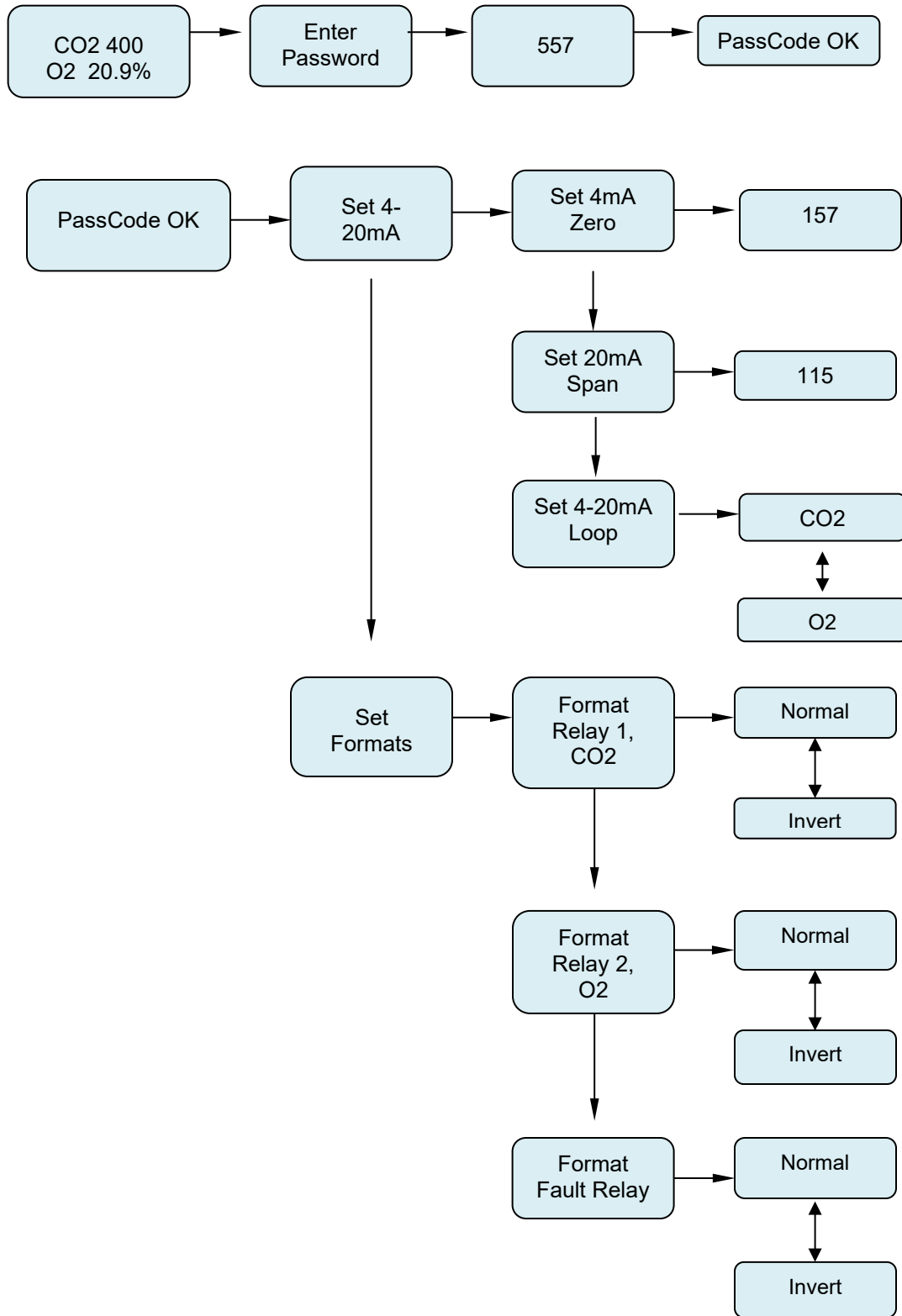

NOTE: All numerical values shown are only examples and are not Factory Defaults

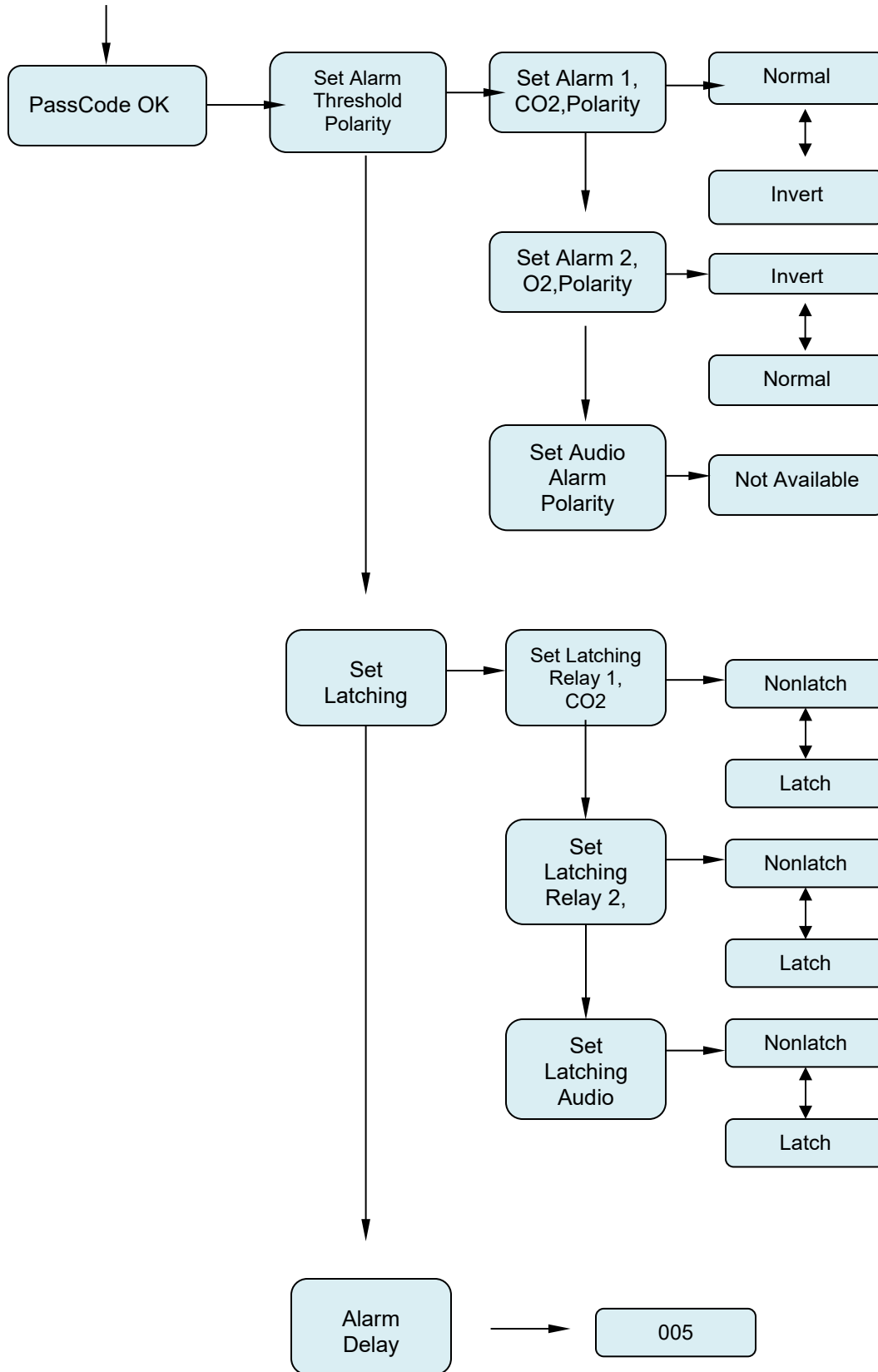

NOTE: Factory defaults are:

CO2 polarity is **Normal**

O2 polarity is **Invert**

The audio horn will activate when the polarity of either gas is changed.

NOTE: All numerical values shown are only examples and are not Factory Defaults

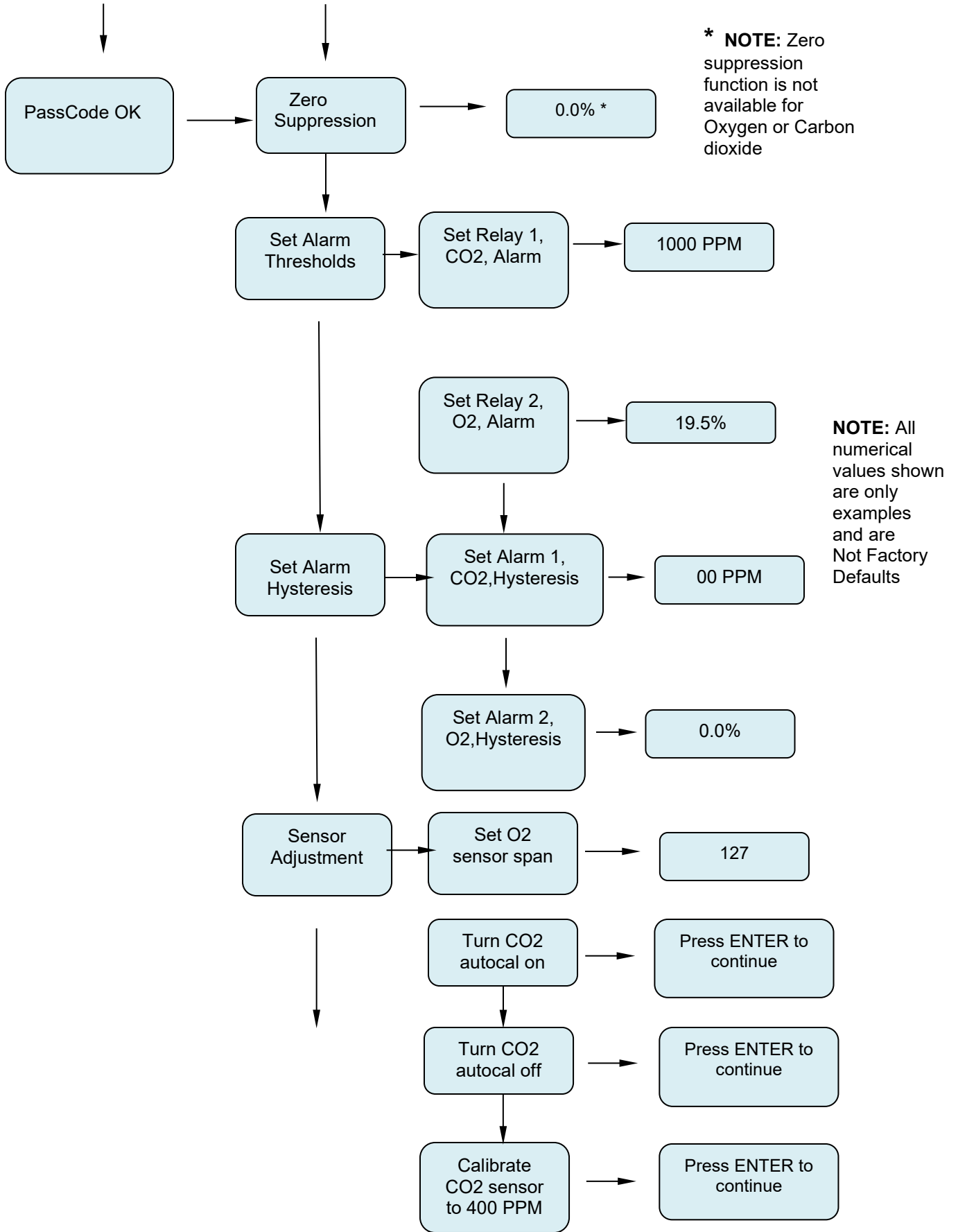

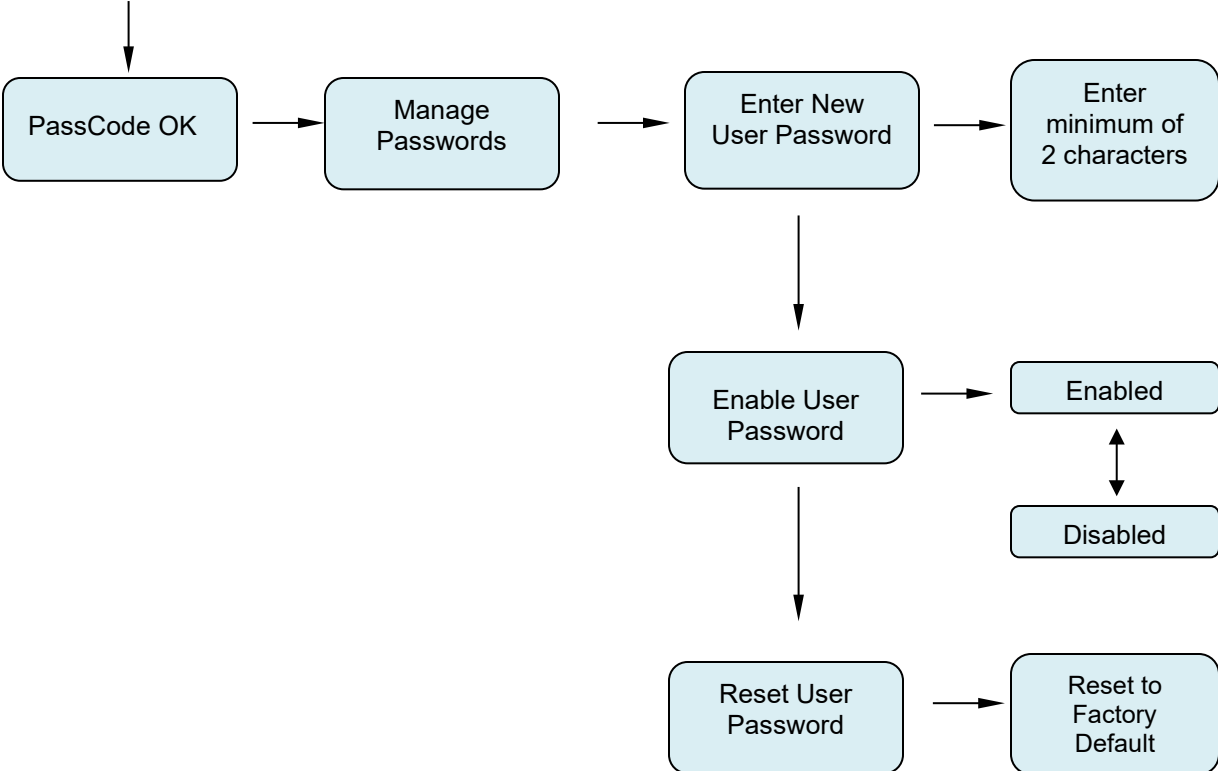

5.3 Entering the Password

The *Dual O2/CO2* Air Check monitor is supplied with a factory set password to prevent unauthorized access to the menus. **The Password is 557.** The following explains how to enter the password.

1. Push the joystick once to the right. **Enter Password** will scroll on the first line of the digital display. The second line will still display the current oxygen level.

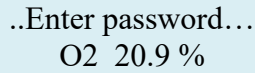

..Enter password...
O2 20.9 %

2. Push the joystick again once more to the right to enter the input screen. **The letter A will appear and flash.**

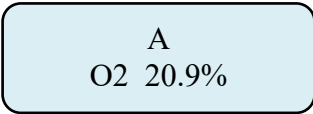

A
O2 20.9%

NOTE: *The display has characters that start with A through Z and 0 through 9. Pushing the joystick up or down will permit you to scroll through the alphanumeric characters.*

3. Push the joystick up or down to enter the first digit. The display is an alphanumeric display and toggles from A through Z followed by 0 to 9. The character to be entered will flash.

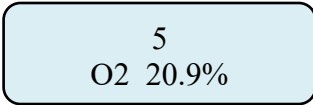

5
O2 20.9%

4. Push the joystick again to the right to select the second entry. Push the joystick up or down to select the second digit. The character being entered will flash and the first character entered will remain lit.

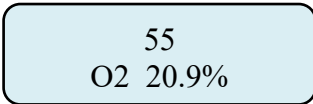

55
O2 20.9%

5. Push the joystick again to the right to select the third entry. Push the joystick up or down to select the third and final digit. The character being entered will flash and the first and second characters entered will remain lit. You are now ready to enter the 3-digit password.

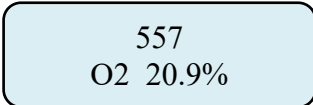

557
O2 20.9%

6. Push the joystick in the center to enter the password. If you entered it correctly the display will scroll **Password OK.**

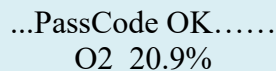

...PassCode OK.....
O2 20.9%

NOTE: If an incorrect password has been entered, the display will indicate **Password Failed.** Push the joystick to the left to access the monitoring mode. From this mode you can reenter the password again.

5.4 Changing the User Password

The **Dual O2/CO2** Air Check monitor is supplied with a factory set password to prevent unauthorized access to the menus. The user can change this password and the following explains how to change the password.

1. Push the joystick down to access the **Manage Passwords Menu**. **Manage Passwords** will scroll on the first line of the digital display. The second line will still display the current oxygen level.

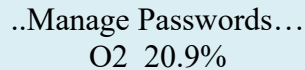

..Manage Passwords...
O2 20.9%

2. Push the joystick to the right to enter the input screen. **Enter New User Password** will scroll on the first line of the digital display

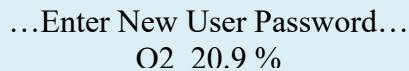

...Enter New User Password...
O2 20.9 %

3. Push the joystick to the right to enter the input screen. **The letter A will appear and flash.**

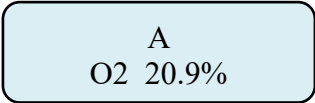

A
O2 20.9%

NOTE: *The display has characters that start with A through Z and 0 through 9. Pushing the joystick up or down will permit you to scroll through the alphanumeric characters.*

4. Push the joystick up or down to enter the first digit. The display is an alphanumeric display and toggles from A through Z followed by 0 to 9. The character to be entered will flash.

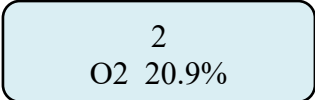

2
O2 20.9%

5. Push the joystick again to the right to select the second entry. Push the joystick up or down to select the second digit. The character being entered will flash and the first character entered will remain lit.

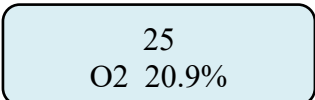

25
O2 20.9%

6. Push the joystick again to the right to select the third entry. Push the joystick up or down to select the third and final digit. The character being entered will flash and the first and second characters entered will remain lit. You are now ready to enter the 3-digit password.

253
O2 20.9%

7. Push the joystick in the center to enter the password. This will display the next command, **Re-Enter New Password**

...Re-Enter New Password...
O2 20.9 %

8. Push the joystick to the right to enter the input screen. **The letter A will appear and flash.**

A
O2 20.9%

9. Push the joystick up or down to enter the first digit. The display is an alphanumeric display and toggles from A through Z followed by 0 to 9. The character to be entered will flash.

2
20.9%

10. Push the joystick again to the right to select the second entry. Push the joystick up or down to select the second digit. The character being entered will flash and the first character entered will remain lit.

25
O2 20.9%

11. Push the joystick again to the right to select the third entry. Push the joystick up or down to select the third and final digit. The character being entered will flash and the first and second characters entered will remain lit. You are now ready to enter the 3-digit password.

253
O2 20.9%

12. Push the joystick in the center to enter the password. If you entered it correctly the display will scroll **“New Password Entry OK”**.

...New Password Entry OK...
O2 20.9%

NOTE: If on the second entry the password entered was different from the first, the display will take you back to the “Re-enter Password Screen”. You will need to repeat steps 2 through 11. If you do not enter the password correctly, the monitor remembers the last password that was properly input.

5.4.1 Enable User Password

This menu permits the user to activate or disable the password function on the Oxygen monitor. Push the joystick down. “**Enable User Password**” will scroll on the first line of the digital display

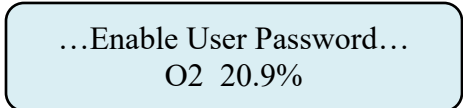

Push the joystick right to display the status. If enabled it will display “**Enabled**”

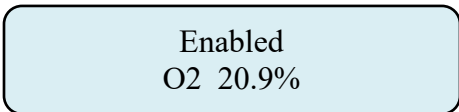

Push the joystick up or down to change the status. Once enabled or disabled is selected, Push the joystick in the center to enter the new status. If correctly entered the display will scroll “**Enable User Password**”

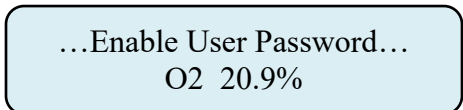

5.4.2 Reset User Password

This menu permits you to reset the password back to 557, as set at the factory.

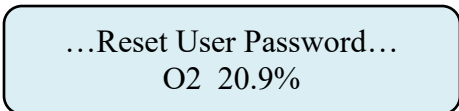

Push the joystick right to display the menu, “**Reset to factory Default**”.

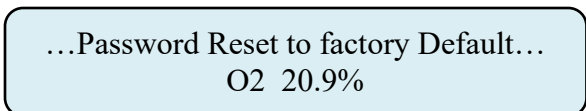

Push the joystick in, (like a doorbell) to reset the password back to 557.
Push the joystick left 4 times to go back to the measuring mode.

NOTE: If you lose your password please contact PureAire with your serial number or DTM number

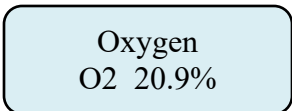

5.5 Entering the Menus

The *Dual O₂/CO₂* monitor is supplied with main menus with sub menus to adjust mA outputs, alarm relay settings, sensor adjustments and zero suppression for toxic and corrosive gas sensor cells.

NOTE: The *Dual O₂/CO₂* monitor can only output one analog mA signal. You must select either O₂ or CO₂. See the section :Set 4-20mA loop source.

5.5.1 Set 4-20mA loop

.Set 4-20mA loop..
O₂ 20.9%

This main menu will permit the adjusting of the 4mA and 20mA output from the *Dual O₂/CO₂* monitor for only one gas: oxygen or carbon dioxide. Once you select the gas this menu will provide the function that will send an actual output between 4mA and 20 mA to test any remote control and alarm system attached to the Dual O₂/CO₂ monitor.

NOTE: *To read the mA output, Dual O₂/CO₂ monitor must either be connected to a remote PLC controller or SCADA system. You can also connect the Dual O₂/CO₂ monitor to a DC ammeter to read the mA output. Please consult PureAire for more information.*

From this main menu, pushing the joystick to the right will select the sub menu and the digital display will scroll the following:

..Set 4mA zero...
O₂ 20.9%

This is the menu at which to adjust the 4mA output being sent from the Dual O₂/CO₂ Monitor.

To change this value, push the joystick right to display the 4 mA setting. The display will indicate a value between 0 and 255 counts. Pushing the joystick up increases the value and pushing the joystick down decreases the value. The 4mA output being sent from the Dual O₂/CO₂ monitor will change as the number on the digital display changes.

255
O₂ 20.9%

Push the joystick to the left to enter the value and bring you back to the pervious Main menu. The digital display will scroll the following:

...Set 4mA zero.....
O₂ 20.9%

Push the joystick down to access the next sub menu; **Set 20mA Span will scroll.**

...Set 20mA Span...
O2 20.9%

This is the menu at which to adjust the 20mA output being sent from the Dual O2/CO2 Monitor.

To change this value, push the joystick right to display the 20mA span setting. The display will indicate a value between 0 and 255 counts. Pushing the joystick up increases the value and pushing the joystick down decreases the value. The 20mA output being sent from the Dual O2/CO2 monitor will change as the number on the digital display changes.

255
O2 20.9%

Push the joystick to the left to enter the value and bring you back to the pervious Main menu. The digital display will scroll the following:

...Set 20mA span.....
O2 20.9%

Push the joystick down to access the next sub menu; **Set 4-20 mA loop source.**

..Set 4-20 Loop source..
O2 20.9%

This is the sub menu used to select the individual gas; (i.e., O₂ or CO₂) that will output the 4-20mA analog signal to your PLC or SCADA system.

To select the gas, push the joystick right once. The first gas to display is O2.

O2
O2 20.9%

If Oxygen is the gas that you wish to send the 4-20mA signal from, push the joystick left once to set this gas and bring you back to the previous Main menu. The digital display will scroll the following:

..Set 4-20 Loop source..
O2 20.9%

To select CO₂ gas, push the joystick right once. The first gas to display is O₂.

O₂
O₂ 20.9%

Push the joystick Down once to display CO₂

CO₂
O₂ 20.9%

If CO₂ is the gas that you wish to send the 4-20mA signal from, push the joystick left once to set this gas and bring you back to the previous Main menu. The digital display will scroll the following:

..Set 4-20 Loop source..
O₂ 20.9%

After selecting the gas, Push the joystick left once to get you back to the next menu. The display will scroll the following:

..Set 4-20 Loop ..
O₂ 20.9%

5.5.2 Set Formats

This is the menu at which to adjust the relay states for the two gas alarm relays and the individual instrument fault relay.

Push the joystick down to access the next main menu, **Set Formats**. The display will scroll the following:

...Set Formats...
O₂ 20.9%

This menu will permit the setting of the two alarm relays and the fault relay settings from normally de-energized state, **Normal**, to normally energized state, **Inverted**.

From this main menu, pushing the joystick to the right will select the sub menu and the digital display will scroll the following:

..Format Relay 1 CO₂...
O₂ 20.9%

This is the menu at which to adjust the CO2 alarm relay state on the Dual O2/CO2 Monitor.

To change this value, push the joystick right to display the relay state. The display will indicate **NORMAL**. This is the factory default state for the alarm relay. Pushing the joystick down will change the relay state from INVERT to NORMAL.

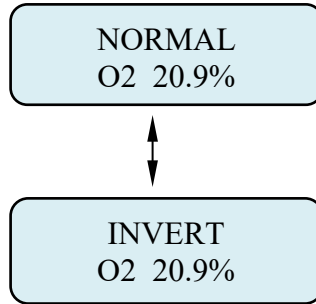

NOTE: When the CO2 relay state is changed to INVERT, the internal horn and Orange alarm LED will illuminate.

After entering the relay state push the joystick left to enter the setting. The display will scroll the following:

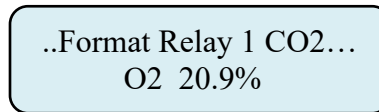

From this main menu, pushing the joystick down will select the next sub menu to adjust the O2 alarm relay state. The digital display will scroll the following:

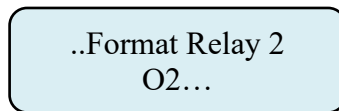

To change this value, push the joystick right to display the relay state. The display will indicate **NORMAL**. This is the factory default state for the alarm relay. Pushing the joystick down will change the relay state from NORMAL to INVERT.

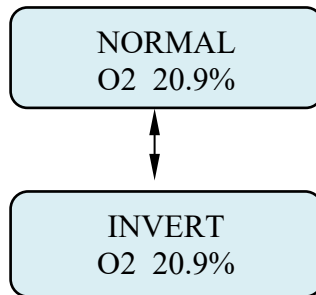

NOTE: When the O2 relay state is changed to INVERT, the internal horn and Red alarm LED will illuminate.

After entering the relay state push the joystick left to enter the setting. The display will scroll the following:

... Format Relay 2 O2..
O2 20.9%

From this main menu, pushing the joystick down will select the next sub menu to adjust the Fault alarm relay state. The digital display will scroll the following:

..Format Fault Relay...
O2 20.9%

To change this value, push the joystick right to display the relay state. The display will indicate **NORMAL**. This is the factory default state for the fault relay. Pushing the joystick down will change the relay state from **NORMAL** to **INVERT**.

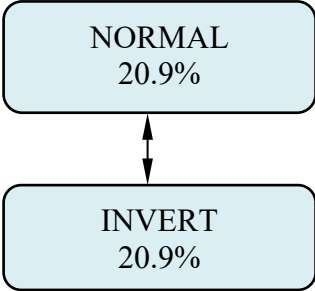

NOTE: When the Fault relay state is changed to INVERT, the internal horn and Yellow alarm LED will illuminate.

After entering the relay state push the joystick left to enter the setting. The display will scroll the following:

..Format Fault
Relay... O2 20.9%

Push the joystick left again to get back to the next menu. The display will scroll the following:

...Set Formats...
O2 20.9%

5.5.3 Set Alarm Threshold Polarity

Alarm Threshold Polarity determines if an alarm concentration is set above or below a threshold value. For example, if an alarm of 19.0% for Oxygen is selected, the Alarm Threshold Polarity must be set to **Invert** for the monitors alarm to activate when the reading goes below 19.0%. For CO₂ gases selecting a **Normal** setting for the Alarm Threshold Polarity means that the system will alarm when the gas concentration exceeds, goes above, an alarm set point. This menu will permit the selection of the alarm polarity. To access this menu from the “Set Formats” menu, push the joystick down to display the **Set Alarm Threshold Polarity** adjustment menu. This will scroll on the digital display.

..Set Alarm Threshold Priority..
O2 20.9%

Push the joystick right to access the first sub menu; **Set Alarm 1 CO₂ Polarity** will scroll on the display. This is the menu at which to adjust the CO₂ alarm polarity state on the Dual O₂/CO₂ Monitor.

..Set Alarm 1, CO₂, Polarity...
O2 20.9%

To change this value, push the joystick right to display the relay state. The display will indicate **NORMAL**. Pushing the joystick down will change the relay state from **NORMAL** to **INVERT**.

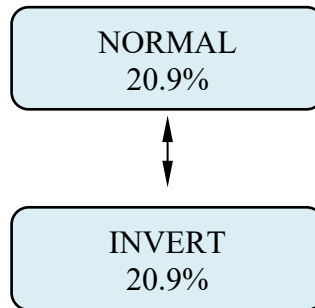

NOTE: When the CO₂ relay state is changed to INVERT, the internal horn and Orange alarm LED will illuminate.

After entering the polarity push the joystick left to enter the setting. The display will scroll the following:

..Set Alarm 1, CO₂, Polarity..
O2 20.9%

Push the joystick down to access the next sub menu; **Set Alarm 2, O₂, Polarity** will scroll on the display. This is the menu at which to adjust the second level alarm polarity state on the Dual O₂/CO₂ Monitor.

..Set Alarm 2, O2, Polarity ..
O2 20.9%

To change this value, push the joystick right to display the relay state. The display will indicate **INVERT**. Pushing the joystick down will change the relay state from INVERT to NORMAL.

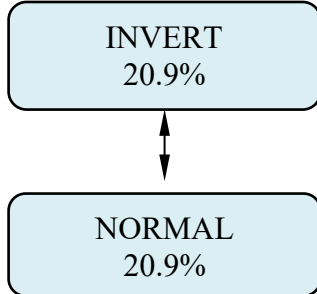

NOTE: When the O2 relay state is changed to NORMAL, the internal horn and Red alarm LED will illuminate.

After entering the polarity push the joystick left to enter the setting. The display will scroll the following:

..Set Alarm 2, O2, Polarity..
O2 20.9%

NOTE: The Set Audio Alarm Polarity is not available on the Dual O2 / CO2 monitor

5.5.4 Set Latching

This is the menu at which to adjust the relay alarm state for both O₂ and CO₂ alarm relays and the individual instrument fault relay. The selection permits setting the relays to a latching or non-latching state. In a latching state, the relay will remain activated until the user manually selects the Enter Key. In a non-latching state, the alarm relay will automatically reset once the gas concentration has returned to 20.9% for oxygen.

...Set Latching...
O2 20.9%

From this main menu, pushing the joystick to the right will select the sub menu and the digital display will scroll the following:

..Set Latching Relay 1, CO2...
O2 20.9%

This is the menu at which to adjust the CO₂ alarm relay state on the Dual O₂/CO₂ Monitor.

To change this value, push the joystick right to display the relay state. The display will indicate **NONLATCH**. Pushing the joystick down will change the relay state from NONLATCHING to LATCHING.

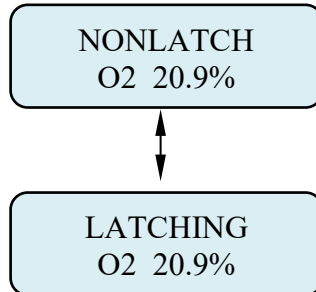

After entering the relay setting push the joystick left to enter the setting. The display will scroll the following:

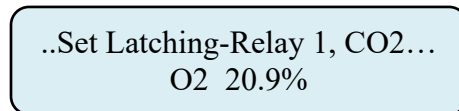

Push the joystick down to access the next sub menu; **Set Latching-Relay 2, O₂**, will scroll on the display. This is the menu at which to adjust the O₂ alarm relay state on the Dual O₂/CO₂ Monitor.

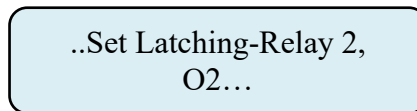

To change this value, push the joystick right to display the relay state. The display will indicate **NONLATCH**. Pushing the joystick down will change the relay state from NONLATCH to LATCHING.

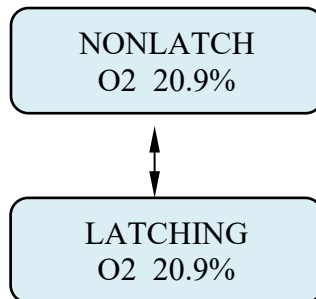

After entering the relay setting push the joystick left to enter the setting. The display will scroll the following:

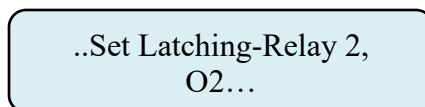

Push the joystick down to access the next sub menu; **Set Latching-Audio Alarm** will scroll on the display. This is the menu at which to adjust the Audio alarm relay state on the Dual O₂/CO₂ Monitor.

..Set Latching-Audio Alarm..

To change this value, push the joystick right to display the relay state. The display will indicate **NONLATCH**. Pushing the joystick down will change the relay state from NONLATCH to LATCHING.

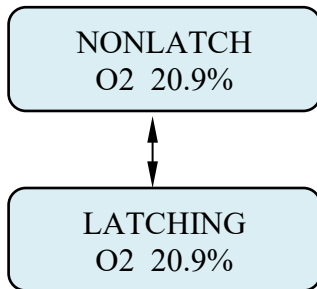

After entering the relay setting push the joystick left to enter the setting. The display will scroll the following:

..Set Latching-Audio Alarm..

5.5.5 Resetting a Latching Alarm

To reset a latching alarm relay, you must enter the password correctly and then push the joystick down to enter the reset command. The Dual O₂/CO₂ monitor also has an internal 2-pin terminal block for connecting a remote reset switch. (See Alarm Relay board, section 1.2.7)

5.5.6 Set Alarm Delay

Push the joystick down to access the next main menu, **Alarm Delay**. The display will scroll the following:

...Alarm Delay...
O2 20.9%

This is the amount of time an alarm level concentration of either oxygen or carbon dioxide must be present before the instrument's gas concentration alarms will be activated. This menu will permit setting a user selected time delay for activating the O₂ and CO₂ alarm.

You can select from 0 seconds up to 255 seconds after an alarm level has been exceeded Before the alarm relays to activate.

To change this value, push the joystick right to display the time screen. The display will indicate a value between 0 and 255 seconds. Pushing the joystick up increases the value and pushing the joystick down decreases the value

005
O2 20.9%

After entering the relay setting push the joystick left to enter the setting. The display will scroll the following:

...Alarm Delay...
O2 20.9%

NOTE: *The alarm delay is only available for O2 and CO2 alarms 1 and 2. There is no delay for the fault relay. Any system fault will immediately activate the Fault Relay.*

5.5.7 Set Zero Suppression

This function not used on the Dual O2/CO2 monitor. It is only used to decrease the sensitivity of selected toxic and corrosive gas sensors. It is totally disabled in the Dual monitor.

5.5.8 Set Alarm Thresholds

..Set Alarm Thresholds..
O2 20.9%

This main menu will permit adjusting the Oxygen concentration percentage and Carbon Dioxide ppm level that will activate their respective alarm relays. It will also activate the internal audio horn.

From this main menu, pushing the joystick to the right will select the first sub menu and the digital display will scroll the following: **Set Relay 1, CO2, Alarm Threshold.**

..Set Relay 1, CO2, Alarm Threshold...
O2 20.9%

This is the gas concentration at which the CO₂ level must be displaying to activate the alarm. To change the displayed value, push the joystick to the right to display the CO₂ level alarm setting. The display will indicate a value between 0 ppm and 10,000 ppm.

Pushing the joystick up increases the value and pushing the joystick down decreases the value.

2500
O2 20.9%

After entering the alarm setting push the joystick left to enter the setting. The display will scroll the following:

..Set Relay 1, CO2, Alarm Threshold...
O2 20.9%

Push the joystick down to access the next sub menu; **Set Relay 2 Alarm Threshold**, will scroll on the digital display.

..Set Relay 2, O2, Alarm Threshold...
O2 20.9%

This is the gas concentration at which the O₂ level must be displaying to activate the alarm. To change the displayed value, push the joystick to the right to display the O₂ level alarm setting. The display will indicate a value between 0 % and 25%.

Pushing the joystick up increases the value and pushing the joystick down decreases the value.

19.50%
O2 20.9%

After entering the alarm setting push the joystick left to enter the setting. The display will scroll the following:

..Set Relay 2, O2, Alarm Threshold...
O2 20.9%

Push the joystick left once to return to the **Set Alarm Thresholds menu**. The display will scroll the following:

..Set Alarm Thresholds..
O2 20.9%

5.5.9 Set Alarm Hysteresis

PureAire’s Dual O2/CO2 monitor may be used as a control system. When used to regulate oxygen or carbon dioxide levels the need of a dead band, “hysteresis” may be required for the alarm relays. This menu will permit the setting of the alarm hysteresis to a desired concentration of both Oxygen and Carbon Dioxide. When using hysteresis, the alarm set point now becomes an average alarm setting for an action to occur. When adding the hysteresis value to the alarm set point, this then defines the alarm and dead band for an action to occur.

For example, if you require a valve to close at 14.9% oxygen level and to reopen again at 15.5% oxygen level, you will set the Alarm Threshold at 15.2% and set the hysteresis value at 0.3%.

Average Alarm set point = 15.2% - Hysteresis 0.3% = 14.9%, Valve Off
Average Alarm set point = 15.2% + Hysteresis 0.3% = 15.5%, Valve On

To access this menu, push the joystick down to display the **Set Alarm Hysteresis** menu. This will scroll on the digital display.

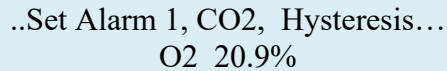

..Set Alarm 1, CO2, Hysteresis...
O2 20.9%

Push the joystick right to access the **Set Alarm 1, CO2, Hysteresis**. It will display a value 00 PPM, (factory default). Pushing the joystick up increases the CO₂ PPM up to a maximum value of 500 PPM. Adjust the digital display until the desired hysteresis value is selected.

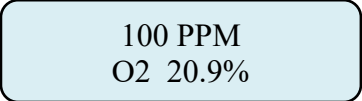

100 PPM
O2 20.9%

After entering the alarm setting push the joystick left to enter the setting. The display will scroll the following:

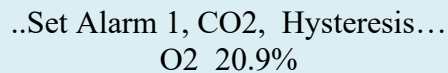

..Set Alarm 1, CO2, Hysteresis...
O2 20.9%

Push the joystick down to access the next sub menu; **Set Alarm 2, O2, Hysteresis**. on the digital display.

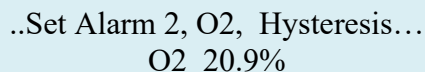

..Set Alarm 2, O2, Hysteresis...
O2 20.9%

Pushing the joystick again to the right will display a value 0.0%. Pushing the joystick up increases the percentage up to a maximum value of 2.5%. Adjust the digital display until the desired hysteresis value is selected.

0.0 %
O2 20.7%

After entering the alarm setting push the joystick left to enter the setting. The display will scroll the following:

..Set Alarm 2, O2, Hysteresis...
O2 20.9%

5.5.10 Set Sensor Adjust (Menu used to adjust both Oxygen and Carbon Dioxide)

Set O2 sensor span

NOTE: It is recommended to warm up the Air Check Oxygen monitor for two hours before making any adjustments to the sensor.

This menu will permit fine-tuning of the oxygen readout to a known concentration of Oxygen. It is recommended to adjust the oxygen display to ambient oxygen levels of 20.9%. To access this menu, push the joystick right to display **Set O2 sensor span**. This will scroll on the digital display.

..Set O2 sensor span...
O2 20.9%

Push the joystick right to access the sensor span. The display will indicate a value between 0 and 255 counts. Pushing the joystick up increases the counts and decreases the percent oxygen value displayed on the Air Check. Pushing the joystick down decreases the counts and increases the oxygen value displayed on the Air Check. As the counts increase and decrease the percent oxygen displayed will also increase and decrease. Adjust the digital display until 20.9% +/- 0.1% is displayed. The actual oxygen reading will fluctuate from 20.8% to 21.0%.

133
O2 20.9%

After entering the alarm setting push the joystick left to enter the setting. The display will scroll the following:

..Set O2 sensor span...
O2 20.9%

5.5.11 Auto Calibrate feature for CO₂ NDIR sensor

The CO₂ sensor can be set to automatically calibrate itself to the ambient carbon dioxide level on earth. The ambient CO₂ level is 400 PPM. The Dual O₂/CO₂ monitor has a menu that permits you to activate this feature by “turning on” this feature. If the Dual O₂/CO₂ monitor is not exposed to constant high levels of CO₂, the sensor will automatically adjust the baseline setting and there is no further action required by the user. The sensor is factory calibrated and requires no user calibration.

To access this menu, go to the Sensor Adjustment main menu.

..Sensor Adjustment..
O2 20.9%

Press the joystick right to access the **Set O₂ sensor span** sub menu.

..Set O2 sensor span..
O2 20.9%

Push the joystick down to access the **Turn CO₂ autocal on** menu. The display will scroll the following:

..Turn CO2 autocal on..
O2 20.9%

To turn ON this feature push the joystick right. The display will scroll the following:

..Press ENTER to continue..
O2 20.9%

Push the joystick in, (like a doorbell) to activate the autocal feature. The audio horn and CO alarm LED will activate momentarily. Every week the CO₂ sensor will automatically adjust back to 400PPM which is the ambient level on earth.

NOTE: DO NOT use the auto calibration feature if you are monitoring continuous levels of CO₂ for control of grow rooms. The monitor needs to be in ambient levels for the autocal feature to operate properly.

You can also disable or “turn off” the auto calibration feature. If the Dual O₂/CO₂ monitor is exposed to constant high levels of CO₂, the user **MUST** inhibit, “turn off” the autocal feature and preform a manual baseline adjustment approximately every six months or more often if desired. To turn OFF the auto calibration feature, push the joystick down to access the menu.

The display will scroll the following:

..Turn CO2 autocal off..
O2 20.9%

To turn OFF this feature push the joystick right. The display will scroll the following:

..Press ENTER to continue..
O2 20.9%

Push the joystick in, (like a doorbell) to activate the autocal feature. The auto calibration feature has now been disabled. You can now **manually** calibrate the CO₂ sensor to ambient 400 PPM one demand. *Refer to section 6.3, Sensor calibration CO₂.*

5.5.12 Main Operation Mode

To select the main menu from any sub menu, push the joystick left until the Main Menu appears. The digital display will indicate the following:

CO2 572
O2 20.9%

6: Maintenance & Sensor Verification

Only qualified personnel should perform maintenance and sensor verification

6.1 Sensor Verification, O₂

The earth is a wonderful source of calibrated oxygen at 20.9%, therefore under ambient conditions; verification of the *Air Check* ✓ O₂ monitor to 20.9% oxygen is constantly being performed. As the oxygen sensor ages over time, it may require a slight adjustment to 20.9%. The O₂ monitor also requires periodic testing with nitrogen to verify the cells response to 0% oxygen.

6.1.1 Sensor Verification Gas

For testing the *Air Check* ✓ O₂ monitor, PureAire recommends the use of nitrogen. This can be purchased from your gas supplier or from the gas supplier listed below.

6.1.2 Sensor Verification Equipment

This can be purchased from your gas supplier or from the gas supplier listed below:

Part Number	Description	Quantity
Calgaz/Air Liquide	Nitrogen 103 liter cylinder, 99.99% p/n CZF6D400281	1
Calgaz/Air Liquide	Regulator, Model 715 500 cc per minute flow p/n CZF7R000255	1

NOTE: If the instrument is connected to a controller, set the controller to the standby mode to avoid accidental alarms.

NOTE: If your safety protocol requires, you may subject the Air Check monitor to different concentrations of oxygen span gas.

*Air Liquide can be reached at 800-638-1197

6.2 Sensor Verification Procedure, O₂

CAUTION: *Be sure to observe all safety guidelines when generating and nitrogen.*

Under ambient non-oxygen deficient environments, **Air Check ✓ O₂** monitor will indicate a display reading of 20.9%. As the sensor ages, the reading may decrease in value. **It is recommended to adjust the reading back to ambient annually.** The following procedure should be used to adjust the reading to 20.9%.

- 1) Ensure that the **Air Check ✓ O₂** monitor is in a clean non-oxygen deficient environment. *(It is also permissible to challenge the monitor to a cylinder of zero air if the monitor is in an oxygen deficient environment)*
- 2) Enter the password. **Refer to Section 5.3**
- 3) Select the **Sensor Adjust** menu.

This menu will permit fine-tuning of the oxygen readout to a known concentration of Oxygen. It is recommended to adjust the oxygen display to ambient oxygen levels of 20.9%. To access this menu, push the joystick down to display the **Sensor Adjustment** menu. This will scroll on the digital display.

NOTE: It is recommended to warm up the Air Check Oxygen monitor for two hours before making any adjustments to the sensor.

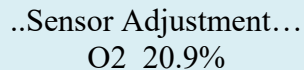

..Sensor Adjustment...
O2 20.9%

Push the joystick right to access the first sub menu; **Set Sensor Span** will scroll on the display. This is the menu that will permit fine adjustment of the ambient oxygen reading to 20.9%.

Push the joystick right to access the first sub menu; **Set Sensor Span** will scroll on the display. This is the menu that will permit fine adjustment of the ambient oxygen reading to 20.9%.

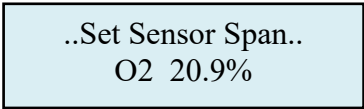

..Set Sensor Span..
O2 20.9%

Push the joystick right to access the sensor span. The display will indicate a value between 0 and 255 counts. Pushing the joystick up increases the counts and decreases the percent oxygen value displayed on the Air Check. Pushing the joystick down decreases the counts and increases the oxygen value displayed on the Air Check. As the counts increase and decrease the percent oxygen displayed will also increase and decrease. Adjust the digital display until 20.9% + / - 0.2% is displayed.

093
O2 20.9%

Press **ENTER** to accept this value. The digital display will revert back to **Set Sensor Span**.

..Set Sensor Span..
O2 20.9%

Press the joystick to the left to revert back to the **Sensor Adjustment** menu.

...Sensor adjustment..
O2 20.9%

6.2.1 Sensor Verification to Nitrogen

PureAire recommends challenging the O₂ monitor with nitrogen every 6 to 12 months. The sensor protector has a ¼" male tube fitting designed for connecting sample tubing from a Nitrogen cylinder. Expose the O₂ cell to N₂ at a flow rate of 500 cc/min. The reading will drop off to 1% or below in less than one minute when the O₂ sensor is exposed to pure N₂. The system will recover to 20.9% when the nitrogen is removed.

NOTE: The Sensor Protector has four air relief holes that will prevent the complete exposure of nitrogen to the oxygen sensor. To see a true zero oxygen level, the entire Air Check ✓O₂ monitor needs be completely immersed into a zero oxygen environment. Covering the holes will help to prevent dilution of the span gas to ambient air.

6.2.2 Sensor Verification to a known concentration of Oxygen

When testing the O₂ monitor to a known concentration of oxygen, the sensor inlet has a ¼" compression tube fitting designed for connecting the sample tubing. You can connect ¼" OD sample tubing from a cylinder filled with Zero Grade air directly to the sensor protector and expose the O₂ cell directly at a flow rate of 500 cc/min.

Expose the monitor for 1 minute and then adjust the reading to 20.9% when using Zero Grade air. Turn off the regulator and remove the Zero grade air from the monitor. The final reading should be within ± 0.3% of the span gas concentration.

To see the exact span gas concentration the entire Dual O₂/CO₂ monitor needs to be completely immersed into the span gas environment.

NOTE: The Dual monitor should be tested in an upright position to allow the span gas to fully saturate the sensor cell.

CAUTION: For best results, the Oxygen monitor should be protected from wind and high airflow when gas calibrating with test gas.

NOTE: To see a true zero, the entire Air Check ✓ O₂ monitor needs to be completely immersed into a zero oxygen environment.

O₂ monitor Connected to gas cylinder



6.3 Sensor Calibration, CO₂

PureAire incorporates the use of an NDIR (Non Dispersive InfraRed) CO₂ sensor in the Dual O₂/CO₂ Monitor. The sensor is factory calibrated and will always provide an accurate reading that is the difference between a baseline setting and the actual CO₂ measurement. As typical with most NDIR sensors, long term drift can affect the baseline setting. To compensate for this drift, an automatic background calibration function is built into the sensor and is enabled by default from the factory. This calibration feature assumes that during a 24 hour period, the monitored CO₂ levels return to normal ambient conditions, such as in an office environment or spaces that are unoccupied during the evening.

If the monitor is constantly exposed to elevated levels of CO₂, for example, in an agricultural growing room, the auto calibration feature should be inhibited, “turned off” and a manual calibration preformed approximately every six months. See Section 5.5.11 to turn off the autocal feature.

CAUTION: DO NOT ADJUST the CO₂ sensor unless you are certain that the CO₂ level has returned to normal ambient conditions, such as in an outdoor environment or spaces that are unoccupied.

To perform a manual adjustment of the CO₂ sensor to ambient 400PPM, use the following procedure. joystick to enter the password, then push the joystick to the right and navigate to the “Sensor Adjustment” menu. The display will scroll

...Sensor adjustment..
O2 20.9%

Push the joystick right once and the display will scroll:

...Set O2 sensor span..
O2 20.9%

Push the joystick down three times to access the **Calibrate CO₂ sensor to 400 PPM** menu. The display will scroll

...Calibrate CO2 sensor to 400 PPM..
O2 20.9%

To manually adjust the baseline setting, expose the monitor to ambient air, either outside or in a well-ventilated room for about 5 minutes. Then push the joystick right to set the new ambient CO₂ ppm level. The display will scroll Press ENTER to continue.

...Press ENTER to continue..
O2 20.9%

Push the joystick in, (like a doorbell) to set the reading to 400PPM. You have now reset the CO₂ sensor to 400PPM. To exit the calibration menu, push the joystick left four times to display the monitoring mode.

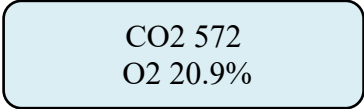

CO2 572
O2 20.9%

7.0 Appendix

CONTACTOR/FAN CONNECTION

EXTERNAL RELAY FOR LOADS >2A

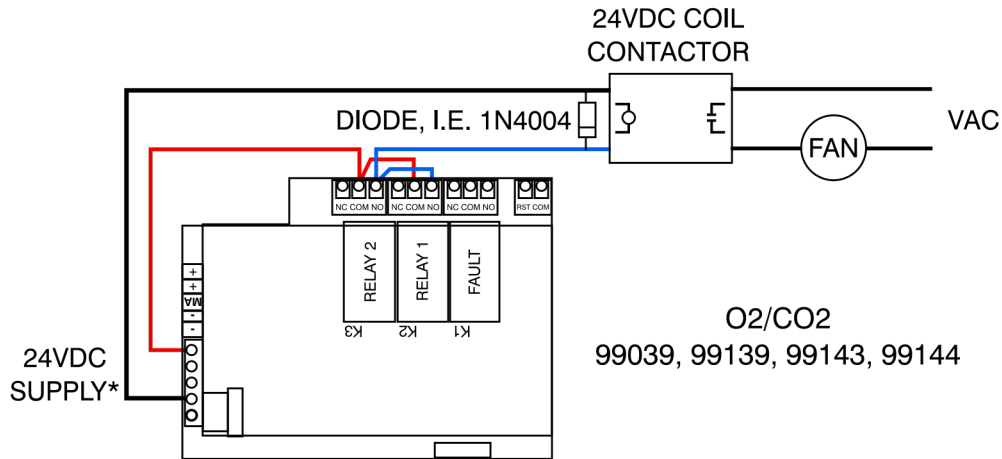
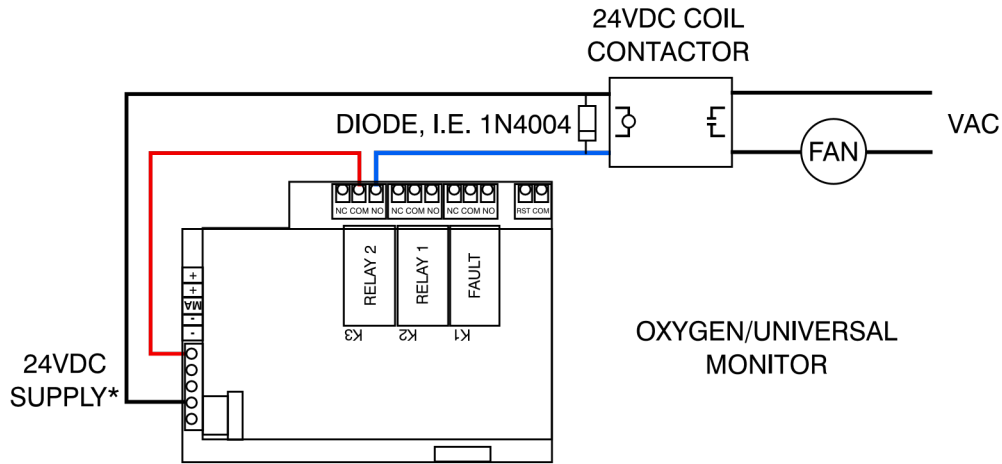

DIAGRAMS FOR 99016, 99029, 99129, 99028, 99145, 99097, 99141, 99035, 99128, 99020, 99045, UNLESS NOTED.

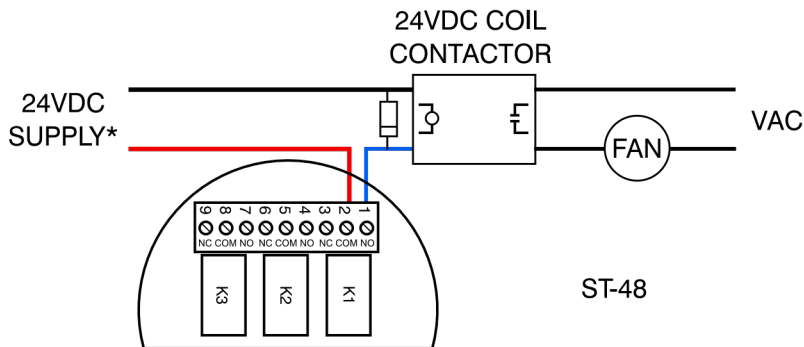

NOTE: ENSURE CONTACTOR CHOSEN HAS CORRECT COIL VOLTAGE AND IS CURRENT-RATED FOR YOUR LOAD

* OK TO USE EXTERNAL SUPPLY AS LONG AS VOLTAGE IS 24VDC/AC OR LESS

How to convert 4-20mA current output to a 1-5 VDC voltage output

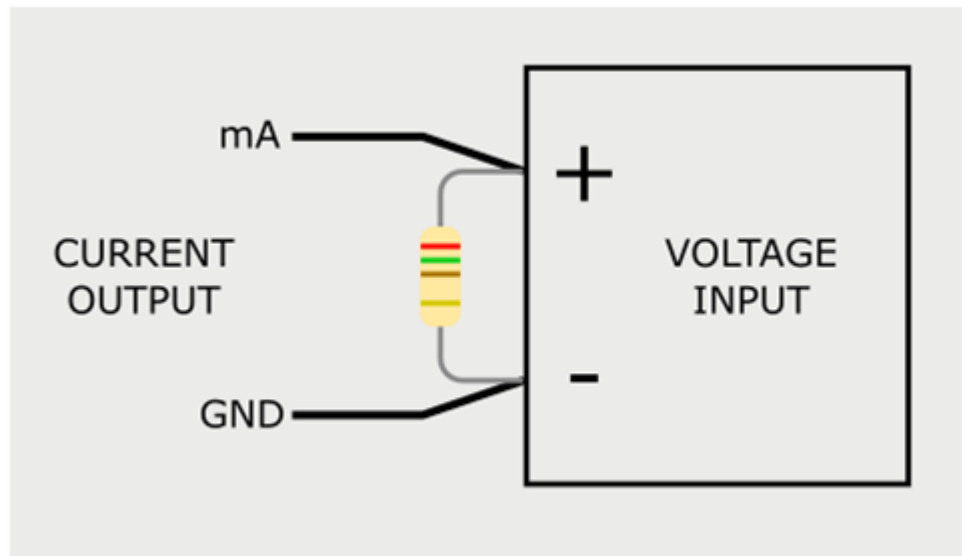
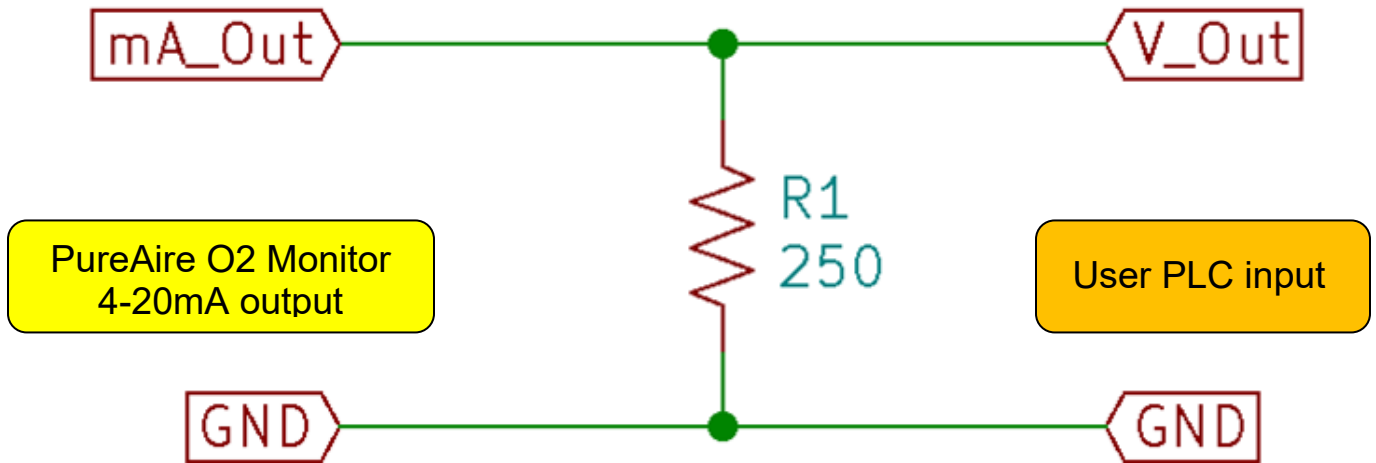

Attach 250-ohm resistor to the PLC or device input