



Operation Manual Round Vacuum Desiccators

Models :

F42400-2021, -2041, -2121, -2141, -2221, and -2241

Manual No. 942402021 Version 1.0



Table of Contents

1	Safety	1
1.1	Operation Manual.....	1
1.2	DANGER/CAUTION/NOTICE Alerts	1
1.3	Danger Alerts	1
1.4	Caution Alerts	3
2	Product Description	4
2.1	Introduction	4
2.2	Characteristics	6
2.3	Components	9
3	Unpacking and Installation.....	10
3.1	Checking Shipment Damage and Unpacking.....	10
3.2	Checking the Contents of the Package.....	10
3.3	Installation	11
3.3.1	Installation Environment.....	11
3.3.2	Installation location	11
4	Operation.....	12
4.1	Operation of the 3-way Valve.....	12
4.2	Vacuum Formation	14
5	Maintenance.....	16
6	Troubleshooting.....	17
7	Accessories.....	18
8	Appendix.....	19
8.1	Technical Specifications.....	19
8.2	Disposal of the Unit.....	20
8.3	Warranty and Disclaimer	20
8.4	After-sales Service and Customer Assistance	20

1 Safety



1.1 Operation Manual

This manual contains important safety and operation information. You must carefully read, understand, and follow all the instructions in this manual prior to operating this instrument. Keep this manual in a safe place nearby for reference and make it easily available to all users.

1.2 DANGER/CAUTION/NOTICE Alerts

This manual highlights DANGER/CAUTION/NOTICE alerts to prevent injury or property damage and also to achieve optimum performance of your instrument.

These alerts are classified into three types in this manual depending on the importance and the risk levels as described below:

Symbols	Meaning
	Ignoring this alert could cause serious or even fatal injury.
	Ignoring this alert could cause serious injury or property damage.
	Ignoring this alert could cause operational problems.

Ensure to read the danger and caution alerts in 1.3 and 1.4 carefully before use.

1.3 Danger Alerts

- ◆ **Never install or use this unit in explosive atmospheres.**



- ◆ **Never install this unit near to hazardous or flammable substances.**
- ◆ **Never disassemble, repair, or modify this unit on your own. Doing so will void your warranty and may result in injuries or product damages.**

1.4 Caution Alerts

 CAUTION
Ignoring the following cautions could cause serious injury or property damage.

- ◆ **Carefully read all the warning labels before using this unit. And do not remove or damage the warning labels.**

- ◆ **Do not move this unit during operation.**

- ◆ **Do not use this unit in wet or moist atmosphere or where water leakage is expected.**

- ◆ **Do not use this unit in contaminated atmosphere or where metallic dust exists.**

- ◆ **Do not expose this unit to any heat sources including direct sunlight.**

- ◆ **Do not allow moisture, organic solvent, dust, or corrosive gases to get into this unit.**

- ◆ **Do not use chlorine bleach, ammonia-based cleaners, abrasives, ammonia, or metal scouring pads. Wipe with a soft damp cloth or a sponge soaked in water or diluted neutral detergent.**



2 Product Description

2.1 Introduction

Congratulations of your purchase of our high-quality round vacuum desiccator which is specially designed to provide maximum benefit for your investment with respect to performance, safety, ease of use, and durability.

Currently six round vacuum desiccator models of are available from Bel-Art Products:

F42400-2021, -2041, -2121, -2141, -2221, and -2241

All models come standard with a vacuum gauge while the models ending in xx41 are amber-tinted and are UV blocking models. These UV blocking models are offered to minimize damages or discoloration of light-sensitive samples by using UV-blocking resin which completely blocks all ranges of UV and the blue spectrum of the visible light.

Being lightweight and yet shatter-resistant, Bel-Art's round vacuum desiccators are safer and more economical alternatives to conventional glass desiccators for both vacuum and non-vacuum applications.

The vacuum environment created by these desiccators provides a very low humidity, contamination-free, corrosion-free, and dust-free condition which is ideal for:

- ◆ drying at low pressure to minimize the heat effects.

- ◆ removing residual solvents or air bubbles



- ◆ cultivating anaerobic microbes

- ◆ minimizing the re-absorption of humidity and the exposure to air during the drying or the cooling stages of biological/medical/food/materials experiments

- ◆ conducting experiments at low pressure

- ◆ drying at low pressure to minimize the heat effects.



2.2 Characteristics

(1) Outstanding Vacuum Sustainment

This unit maintains a 1 Torr (133 Pa) vacuum for over 72 hours at room temperature and stays gastight allowing reliable experiments over extended periods.

(2) Molded Polycarbonate Body and Base

The body and the base of this unit are made of shock-resistant, highly tensile, and transparent polycarbonate to provide extreme durability as well as convenient visual observation from outside.

The body is molded as a single piece requiring no adhesive and, therefore, allows virtually no leakage.

(3) Viton® 3-Way Valve

This unit comes standard with a leak-proof Viton® 3-way valve offering consistent and uniform vacuum draw, vacuum release, or gas exchange without the inconvenience of connecting and disconnecting pump hoses to the unit.

If needed, an additional 3-way valve can be attached to the port at the base.

(4) Locker



This unit is equipped with a locker which allows tight sealing for both vacuum and non-vacuum applications. In addition, this locker provides additional convenience and safety when moving the unit.

(5) Wide Range of Models

Currently six different models of are available: **F42400-2021, -2041, -2121, -2141, -2221, and -2241**. These models come in three different capacities to suit the user's needs with the internal volume of 6, 10 or 20 liter .

(6) Easy Vacuum Level Checking

The vacuum gauge installed on top of the body allows convenient checking of the vacuum level. All models include a vacuum gauge.

(7) UV Blocking

These UV blocking models (**F42400-2041, -2141, and -2241**) are offered to minimize damages or discoloration of light-sensitive samples by using UV-blocking resin which completely blocks all ranges of UV and the blue spectrum of the visible light.

(8) High Quality Vacuum Seal

The silicone gasket ensures reliable vacuum formation and sustainment without using any grease. For easy cleaning and maintenance, the vacuum seal is specially designed



to fit snugly into the bottom groove of the body.

(9) Desiccant Tray

All models come with a desiccant tray. Desiccants are sold separately.

2.3 Components

Round Vacuum Desiccators

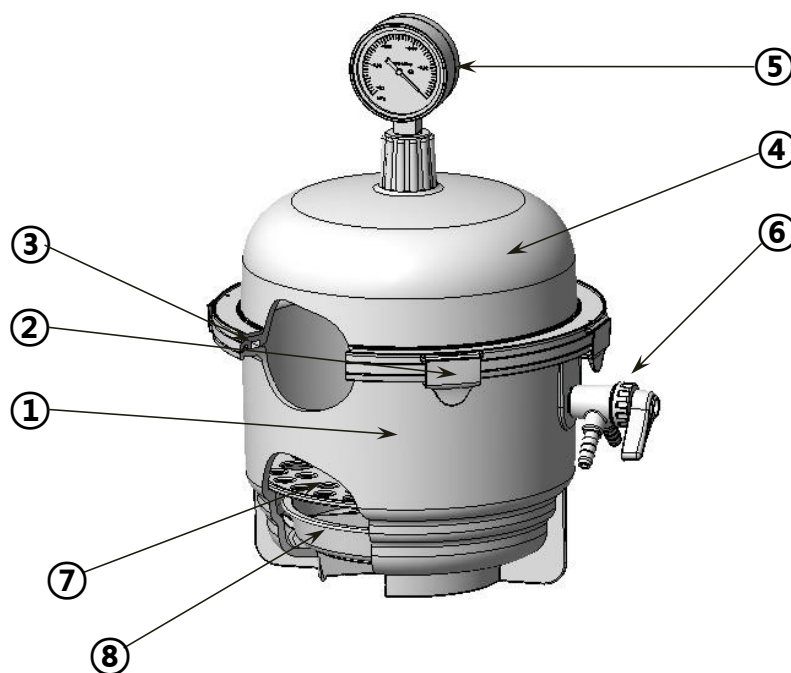

- (1) **Desiccator jar**
- (2) **Flange Locker**
- (3) **Silicone Gasket**
- (4) **Desiccator cover**
- (5) **Vacuum Gauge**
- (6) **3-Way Valve**
- (7) **Perforated Sample Tray**
- (8) **Desiccant Tray**





3 Unpacking and Installation

3.1 Checking Shipment Damage and Unpacking

Upon receiving the instrument, check to ensure that no damage has occurred during shipment. It is important that any damage that occurred during shipment is detected before unpacking. If you find such damage, the carrier must be notified immediately.

3.2 Checking the Contents of the Package

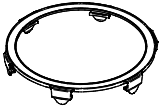
After unpacking, check to ensure that all the parts and accessories described below are included in the package. If not, contact your dealer immediately.

Item	Figure	Quantity
Main Body	-	1
3-Way Valve		1
Silicone Gasket		1
Flange Locker		1
Perforated Sample Tray	-	1
Desiccant Tray	-	1
User Manual		1

3.3 Installation

3.3.1 Installation Environment

NOTICE
Avoid exposure to any heat sources including direct sunlight.

This unit is designed for indoor use in laboratory environments. The conditions for proper installation are as follows:

Permissible Ambient Temperature	5 to 40°C (41 to 104°F)
Permissible Relative Humidity	Below 80%
Permissible Altitude	0 to 2,000 m (6,562 ft)

3.3.2 Installation Location



NOTICE
<ul style="list-style-type: none"> ● Install the unit on a level surface ● Install the unit at least 30cm away from other equipment

4 Operation

⚠ CAUTION

- Do not form a vacuum when airtight containers are inside the unit
- Note that this unit cannot be autoclaved
- When attaching an additional 3-way valve or some other equipment after removing the port plug, use a proper O-ring for tight sealing
- When putting high-temperature samples inside the unit, cool them thoroughly in advance or make sure that they are not in direct contact with the interior of the unit to avoid interior damage

4.1 Operation of the 3-Way Valve

ITEM	Front Nozzle	Rear Nozzle
 <div style="display: flex; justify-content: space-between; width: 100px; margin: 0 auto;"> Rear </div> <div style="display: flex; justify-content: space-between; width: 100px; margin: 0 auto;"> Front </div>	Open	Closed
	Closed	Open

	Closed	Closed
---	--------	--------

4.2 Vacuum Formation

The procedures for vacuum formation are as follows:

- (1) Connect the vacuum pump hose to one of the two nozzles of the 3-way valve
- (2) After activating the vacuum pump, turn the valve handle towards the nozzle to open it and read the vacuum gauge to check whether the vacuum is forming properly
- (3) When the desired vacuum level is achieved, turn the valve handle until it is perpendicular to the nozzle to close it and check the vacuum gauge whether there is any leakage
- (4) When releasing the vacuum, slowly turn the valve handle towards the opposite nozzle to return to the normal pressure

..

⚠ CAUTION

- Do not impact or drop the unit when a vacuum is formed inside
- When forming or releasing a vacuum, turn the valve handle slowly to avoid rapid pressure change. If not, the stored samples can be damaged or dispersed
- When forming a vacuum, install a cold trap in front of the vacuum pump. Moisture and chemicals from the samples may result in damages to the pump.
- Do not let the body of the unit into direct contact with acetone, benzene, toluene, chloroform, cresol, sodium hydroxide, highly concentrated nitric or sulfuric acid, acetic acids, or strong chlorine-based solvents
- Ensure that the silicone gasket is not damaged by strong acid or base. Damaged gasket can cause malfunction of the unit
- When a vacuum is formed inside the unit, do not apply excessive force to the 3-way valves, the vacuum gauge, or any of their vicinities. Any damages caused by external forces can cause malfunction of the unit
- When the unit is not forming a vacuum, keep the valve handle perpendicular to the nozzles
- When relocating the unit, do not carry by the protruded parts such as the vacuum gauge or 3-way valves

5 Maintenance

CAUTION

- If the unit is contaminated, wear chemicals-resistant gloves before cleaning
- Regularly check the 3-way valves, the vacuum gauge, or any of their vicinities for any damage
- Regularly check the vacuum seal as well as the surface where the body and the base are in contact and keep them always clean and undamaged
- Make sure to clean the silicone gasket regularly using diluted neutral detergent. For thorough cleaning, detach the seal from the lid
- Do not use chlorine bleach, ammonia-based cleaners, abrasives, organic solvents, or metal scouring pads when cleaning. Use a soft cloth all the time.

6 Troubleshooting

Problem	Cause	Corrective Action
Vacuum Malfunction	Contaminated surface between the body and the base	Thoroughly clean the surface with a soft cloth using diluted neutral detergent
	Damaged gasket	Replace the gasket
	Unsuitable room temperature	Check the temperature whether it is within the operating range
	Misplaced or damaged 3-way valve	Check whether the valve is properly set. If damaged, replace it with a new one
	Damaged vacuum gauge	Replace the gauge



7 Accessories

See enclosed addendum for Accessories Parts List

8 Appendix

8.1 Technical Specifications

Models F42400-		-2021 -2041	-2121 -2141	-2221 -2241
Internal Volume (L)		6	10	20
Vacuum	Gauge Range (MPa)	0 ~ -0.1 (Analog)		
	Max. Permissible	1.33 x 10 ⁻⁴ MPa (1Torr)		
	Nozzle Diameter (mm)	Ø 9.5		
Material	Cover/Jar	PC (Polycarbonate)		
	Tray, Flange Locker	PP (Polypropylene)		
	Vacuum Gasket	Silicone		
Dimensions (mm)	Overall(mm, WxH)	286 x 279 (286 x 354)	353 x 325 (353 x 400)	427 x 399 (427 x 475)
	Net weight(kg)	1.5(1.7)	2.5(2.6)	4.2(4.3)
Tray	Perforated Sample Tray(mm)	192	250	310
	Max load(Kg)	15	20	25
Color*		Clear		
UV Protection (Range)*		UV A,B,C 100% (200~450nm)		

*Note: Models F42400-2041, -2141, and 2241 are Amber color and have the UV blocking capabilities indicated above



8.2 Disposal of the Unit

Disposing of the unit must be done in an environmentally responsible way if it has been potentially exposed to bio-agents or radioactive samples. Failure to follow stringent requirements for appropriate disposal may lead to actions against you and your organization.

- (1) First, check with your laboratory or organization to ensure that you are following all the policies and procedures for disposal of laboratory equipments and wastes.
- (2) If not possible, contact your local governing body for regulations regarding disposal of laboratory equipments. Jeio Tech highly recommends you to find a local service provider that can properly dispose of your unit.

8.3 Warranty and Disclaimer

See enclosed Warranty Card for conditions and requirements.

8.4 After-sales Service and Customer Assistance

Our after-sales service responds to your questions concerning maintenance and repair of your unit as well as spare parts. In case of a warranty claim, repair or purchase of replacement parts or in case of queries or other problems, please contact your local dealer or Bel-Art Products representative.



- ◇ The contents of this manual can be changed or upgraded without prior notice.
- ◇ The copyright of this manual is reserved by Bel-Art Products.



Addendum to User Manual

Accessories Parts List for Round Model Desiccators

Bel-Art Accessory No.	Unit of Measure	Accessory Description	Used with Bel-Art Desiccator Number(s)
942402035	EA	Vacuum Gauge	F42400-2021, -2041, -2121, -2141, -2221, -2241
942402034	EA	Seal	F42400-2021, -2041
942402033	EA	Seal	F42400-2121, -2141
942402032	EA	Seal	F42400-2221, -2241
942402031	EA	Desiccant Tray	F42400-2021, -2041
942402030	EA	Desiccant Tray	F42400-2121, -2141
942402029	EA	Desiccant Tray	F42400-2221, -2241
942402028	EA	Perforated Shelves	F42400-2021, -2041
942402027	EA	Perforated Shelves	F42400-2121, -2141
942402026	EA	Perforated Shelves	F42400-2221, -2241
942402025	EA	Flange Locker	F42400-2021, -2041
942402024	EA	Flange Locker	F42400-2121, -2141
942402023	EA	Flange Locker	F42400-2221, -2241
942402022	EA	3-Way Valve (For Round)	F42400-2021, -2041, -2121, -2141, -2221, -2241
942402021	EA	User Manual - Round Models	F42400-2021, -2041, -2121, -2141, -2221, -2241

661 Route 23 South, Wayne, NJ 07470

TEL: 1-800-4BEL-ART • FAX: 973-694-7199 • www.belart.com

Scienceware® is a registered TM of Bel-Art Products.
 Bel-Art Products assumes no obligation or liability for any advice furnished by it, or for results obtained with respect to these products.
 All such advice is given and accepted at the buyer's risk.
 © 2012 Bel-Art Products. All Rights Reserved.

