

WELCH-ILMVAC

OWNER'S MANUAL FOR SELF-CLEANING DRY VACUUM SYSTEM™ MODELS: 2025, 2026, 2027 & 2028



2025
(9 Torr, 12 mbar)



2027
(2 Torr, 2.7 mbar)



2028
(2 Torr, 2.7 mbar)

2026
(2 Torr, 2.7 mbar)

Improved to better meet your laboratory needs.

- New electronics with an enhanced self-cleaning feature to help extend diaphragm life
- Superior vacuum level regulator for setting vacuum pressures
- Improved corrosion resistant housing and front panel
- Protective jar cover to help protect inlet and outlet jars



WARNING

Be sure to properly identify intake and discharge before using pump. See Section 2.14



CAUTION

Do not pump liquids with the pump.
Pumping liquids will cause the pump to stop working.

Welch-Ilmvac
5621 W. Howard Street
Niles, IL 60714
Phone: (847) 676-8800 (Technical Support)
Fax: (847) 677-8606
E-Mail: gdwelchvacuum@gardnerdenver.com
Web-Page: www.welchvacuum.com

Part No. 642835
Printed in USA

INSTRUCTION
WARNING AND CAUTION
PLEASE READ BEFORE OPERATION

While reading your manual, please pay close attention to areas labeled:
WARNING AND CAUTION.
The description of each is found below.

WARNING
Warnings are given where failure to observe instruction could result in injury or death to people.

CAUTION
Cautions are found where failure to observe the instruction could result in damage to the equipment, associated equipment and process.

These units confirm to the SI International system of units of measurement.

The following symbols (with recommendation of IEC1010) of warning will be found on the pump.



Caution - refer to accompanying documents



Caution - risk of electrical shock



Caution - hot surface

WARNING
Motor includes a self resetting thermal cutout and the pump could restart without actuation under fault condition.

TABLE OF CONTENTS

SECTIONS	PAGE
Section 01 - Safety Information	
1.10 To Prevent Injury	04
1.20 To Reduce Risk of Electrical Shock	04
1.30 To Reduce Risk of Electrocution	04
1.40 To Reduce Risk of Explosion or Fire	04
Section 02 - Installation	
2.10 Introduction	05
2.20 Electrical Power	06
2.30 Traps	07
Section 03 - Component, System and Unit Operations	
3.10 Component Description	09
3.20 Control Locations	09
3.30 Vacuum Gauge / System Control Function	10
3.40 Vacuum Level Regulation	16
3.50 Gas Ballast Valve	16
3.60 Rapid Response Vacuum Adjustment	16
3.70 Inlet and Exhaust Separators	17
3.80 Unit Start Procedure and Operation	17
Section 04 - Maintenance	
4.10 General Maintenance	18
Section 05 - Calibration	
5.10 Calibration for Model 2027 only	18
Section 06 - Troubleshooting	
6.10 Vacuum Problems	20
Section 07 - Specification	
7.10 Pump Specification Table	23
Section 08 - Drawings, Parts List and Exploded View	
8.10 Dimensional Drawing	24
8.11 Schematic Wiring Diagram for Models 2025 and 2026	24
8.12 Schematic Wiring Diagram for Model 2027	25
8.13 Schematic Wiring Diagram for Model 2028	25
8.14 Parts List and Exploded View for Dry Vacuum System	27
8.15 Parts List and Exploded View for Repair Kits	28
Section 09 - Warranty	29

Section 1: SAFETY INFORMATION

- 1.10 To prevent injury....
- 1.11 Never operate this product if it has a damaged cord or plug. If it is not working properly, has been dropped, damaged or has fallen into water, please return the product to a Gardner Denver Welch Vacuum Technology service center for examination and repair.
- 1.12 Keep the cord away from the heated surfaces.
- 1.13 Never block any air openings or place it on a soft surface where the openings may be blocked. The air openings are for ventilation of the motor inside the housing. Keep all air openings free of lint, dirt and other foreign objects.
- 1.14 The PTFE pump is thermally protected and can automatically restart when the protector resets. Always disconnect power source before servicing.
- 1.15 Wear safety glasses or goggles when operating this product.
- 1.16 Use only in well ventilated areas. The motor is fan cooled enclosed in a shell.



WARNING

Do not operate the pumps in an atmosphere containing flammable or explosive gases/vapors.



WARNING

Never block the exhaust port. If the exhaust is blocked, pressure will build-up in the pump with the potential of the pump head bursting and causing possible injury to personnel in the area.

- 1.17 All electrical products generate heat. To avoid serious burns never touch unit during or immediately after operation.
- 1.18 Be sure to properly identify intake and discharge before using pump. See Section 2.14.



WARNING

Remove plug(s) from Exhaust Port(s). The Self cleaning Dry Vacuum System has one outlet port and one inlet port. The ports are labeled.

- 1.20 To reduce risk of electrical shock....
- 1.21 Do not disassemble. Disassembly or attempted repairs if accomplished incorrectly can create electrical shock hazard. Refer servicing to qualified service agencies only: Contact your closest Gardner Denver Welch Vacuum Technology sales office. See directory on back cover.
- 1.22 Unit is supplied with a three pronged plug. Be sure to connect pump to a properly grounded outlet only.
- 1.30 To reduce risk of electrocution...
- 1.31 Do not use this product in or near area where it can fall or be pulled into water or other liquids.
- 1.32 Do not reach for this product if it has fallen into liquid. Unplug immediately.
- 1.33 Never operate this product outdoors in the rain or in a wet area.
- 1.40 To reduce risk of explosion or fire...
- 1.41 Do not use this pump near explosive atmospheres or where aerosol (spray) products are being used.
- 1.41 Do not use this product near flames.



WARNING

Failure to observe the above safety precautions could result in severe bodily injury, including death in extreme cases.

Section 2: INSTALLATION

2.10 Introduction

This manual has been compiled not only for the care and maintenance of the Welch Dry Vacuum System now in your possession, but as a helpful reference and guide to prevent many problems which can occur if used improperly.

2.11 Unpacking

Carefully remove the Dry Vacuum System from the shipping carton. Preserve all paperwork for future reference. If damage has occurred from shipment a claim must be filed with the carrier immediately; preserve the shipping carton for inspection by the carrier. If you are required to communicate with your dealer or Welch-Ilmvac be sure to include your order numbers for quick identification. Do not return the system to the factory without first calling for a returned goods number. Contact your closest Welch-Ilmvac sales office.

2.12 System Mounting

Rubber feet are attached to the pump. Rubber feet are excellent for applications involving a semi-flexible surface such as a bench top; they help to isolate noise and eliminate creeping. The Self-Cleaning Dry Vacuum System must be positioned with the feet on a flat surface.

2.13 System Location

The Self-Cleaning Dry Vacuum System should be located preferably in a clean, dry and well ventilated area. Please be sure not to block the ventilation ports located on the metal shell. The pump should be placed where the surrounding temperature remains between 10°C and 40°C (50°F and 104°F). Always check to insure the location chosen is protected from direct or indirect moisture contact. The pump should be located as closely to its system in order to utilize it most efficiently.



WARNING

Don't operate this pump in an atmosphere containing flammable or explosive gases or vapors.



CAUTION

If operating the unit in a hood, be aware of other hood uses and users – always avoid activities that could compromise unit function. For example, an acid digestion in the hood with the pump system will destroy unit electronics.



WARNING

Do not position the equipment so that it is difficult to operate the disconnecting device. (Removal of the plug or power cord from the socket outlet).

2.14 Inlet and Outlet Provisions

An inlet hose barb which accepts ¼" (7mm) I.D. hose makes it easy to connect the system to your concentrator, rotary evaporator or gel dryer. Since the vacuum system operates in the viscous flow range, the small diameter of the hose will generate minimal conductance loss. For best results, Welch recommends the length of the tubing between the pump and the apparatus be kept as short as possible. Hose clamps should be used to hold the hose in place. The hose barb in the outlet port of the pump accepts ¼" (7mm) I.D. hose. A vent line can be attached to the outlet hose barb which allows gases and vapors pumped through the pump to be piped to a fume hood. If you any questions, be sure to call technical service prior to start-up. Contact your closest Gardner Denver Welch Vacuum Technology sales office.



WARNING

Never Block The Outer Port. If the outlet is blocked, pressure will buildup in the pump which can lead to the pump head bursting creating the potential of serious injury. Remove plug from outer port.

PROPERLY IDENTIFY THE INLET AND OUTLET OF THE PUMP



(Model 2028 shown)

WARNING:
Remove Plug From Exhaust
Port Before Operating.

2.20 Electrical Power

2.21 Power Source Review

Review the power source and the voltage rating on the units serial number tag to be sure they agree in voltage, phase and frequency. Serious damage may occur to the system if it is connected to an improper voltage. All Welch systems must be grounded. Grounding reduces the risk of electric shock in the event of an electrical short circuit. The plug must be plugged into an outlet properly grounded. Consult your local electrical codes if you have doubts.

2.22 Identification Symbols ○ OFF (Power) on Models:

| ON (Power) 2025, 2026 & 2027

Ⓢ on Model:

2028

2.23 Grounding Instructions

This product should be grounded. In the event of an electrical short circuit, grounding reduces the risk of electric shock by providing an escape wire for the electric current. This product is equipped with a cord having a grounding wire with a grounding plug. The plug must be plugged into an outlet that is properly installed and grounded in accordance with all local codes and ordinances.



WARNING

Improper installation of the grounding plug
can result in a risk of electrical shock.

If repair or replacement of the cord or plug is necessary, do not connect the grounding wire to either flat blade terminal. The wire with insulation having an outer surface that is green with or without yellow stripes is the grounding wire.

Check with a qualified electrician or serviceman if the grounding instructions are not completely understood, or if in doubt as to whether the product is properly grounded. Do not modify the plug provided; if it will not fit the outlet, have the proper outlet installed by a qualified electrician.

Model's 202501, 202601, 202701 and 202801 are for use on a nominal 120V circuit, and has a grounding plug that looks like the plug illustrated in Sketch A in Figure #1. A temporary adapter, which looks like the adapter illustrated in sketches B and C, may be used to connect this plug to a 2-pole receptacle as shown in sketch B if a properly grounded outlet is not available.

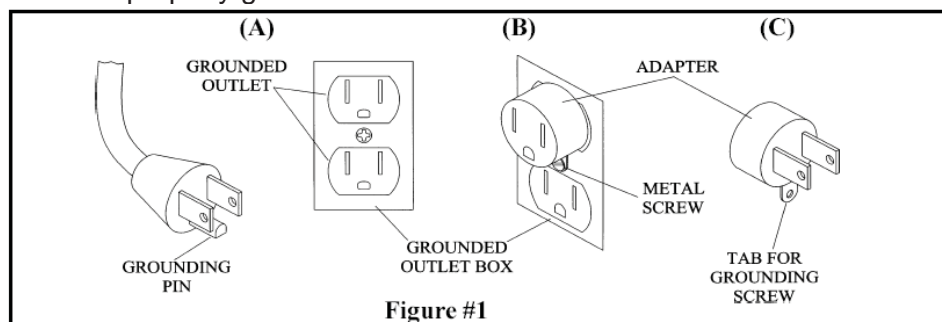

Figure #1

The temporary adapter should be used only until a properly grounded outlet (Sketch A) can be installed by a qualified electrician. When using the temporary adapter, the green colored rigid ear, lug, etc. extending from the adapter must be connected to a permanent ground such as a properly grounded outlet box cover. Whenever the adapter is used, it must be held in place by a metal screw.

2.24 Extension Cords

If necessary to use an extension cord, use a 3-wire extension cord that has a 3-blade grounding plug, and a 3-slot receptacle that will accept the plug on the product. Make certain your extension cord is in good condition. Make certain your extension cord wire size is not less than 18 gauge for 25 feet, 16 gauge for 50 feet, and 14 gauge for 100 feet. An undersized cord will cause a drop in line voltage resulting in loss of power and overheating. If in doubt, use the next heavier cord. The smaller the gauge number, the heavier the cord. Avoid routing the extension cord through areas that could result in damage to the cord.

2.30 Traps

2.31 When To Use A Trap

The Self-Cleaning Dry Vacuum System is constructed of PTFE or fluorinated plastics on all wetted surfaces to resist chemical attack from aggressive solvent, base and acid vapors. A totally oil free diaphragm mechanism removes the need for lubricating and sealing fluids for pulling a vacuum. When pumping gases or low vapor loads, a trap is not necessary unless you want to capture vapors evolved from the process. When a heavy load of water or organic vapor is evolved from the vacuum process, condensation of vapor in the pump mechanism may occur. The reason is the pump is compressing the vapor as it passes through the pump. If the vapor is dense enough, the compression will cause condensation of the vapor in the pump mechanism. The valve system in the pump mechanism is designed to pass the small quantity of liquefied vapor formed when pumping heavy vapor loads. The liquid formed will be ejected from the outlet port. The self-cleaning purge feature of the Self-Cleaning Dry Vacuum System is designed to eject condensed vapors left in the pump upon shut-down.

The advantage of a cold trap when pumping heavy vapor loads is that it will increase the effective pumping speed of the Self-Cleaning Dry Vacuum System. The trap acts as an additional pumping mechanism, increasing the effective pumping speed. This higher effective pumping speed will shorten the time needed to strip solvent. The time savings will depend on such factors as the solvent stripped, solvent temperature and operating temperature of the cold trap.

The cold trap is installed between the pump and the vacuum chamber. The water or organic vapors evolved from the vacuum process entering the cold trap will come in contact with the cold surfaces of the trap and condense. Commonly used refrigerants are liquid nitrogen or dry ice with alcohol slurry. Dry ice provides sufficient cooling to freeze out most heavy water vapor loads. A variety of cold traps are available from Welch. Visit the Welch Web-Site at www.welchvacuum.com.

2.32 Solvent Traps

Your Self-Cleaning Dry Vacuum System comes with a basic solvent removal capability to remove readily condensable solvents prior to pump ingestion and to collect solvent accumulated during pump condensation and the Self-Cleaning cycle. Solvent removal can be further enhanced to provide additional pumping efficacy, safety, solvent fate control, and pump life. Depending upon your application, additional solvent trapping may be desirable. Solvent trapping configurations are discussed below; consult your Welch representative for application specific trapping recommendations.

2.33 Self-Cleaning Dry Vacuum System Solvent Removal

When pumping gases or low vapor loads, a trap is not necessary unless you want to capture vapors evolved from the process. When a heavy load of water or organic vapor is evolved from the vacuum process, condensation of vapor in the pump mechanism may occur due to compression. The valve system in the pump mechanism is designed to pass a small quantity of liquefied vapor formed when pumping heavy vapor loads. The liquid formed will be ejected from the outlet port. The self-cleaning purge feature of the Self-Cleaning Dry Vacuum System is designed to eject condensed vapors left in the pump upon shut-down and collect condensate in the side-mounted jar.

2.34 Cold Trap Solvent Removal

Condensation of organic solvent fumes is typically accomplished by suspending a trap in a Dewar flask containing dry ice / isopropanol slurry or liquid nitrogen. Alternatively low maintenance cooling to -100°C can be achieved using a refrigerated cold trap. The cold trap is connected between the application and the pump unit to prevent solvent ingestion. Installation of a cold trap when pumping heavy vapor loads offers several advantages:

- The Self-Cleaning Dry Vacuum System will operate more efficiently. The trap acts as an additional pumping mechanism, increasing the effective pumping speed. This higher effective pumping speed will shorten the time needed to strip solvent.
- The absence of a high solvent load in the pump diaphragm mechanism promotes pumping efficiency and extends diaphragm life.
- Vacuum pump pass-through of solvents is reduced, preventing possible discharge into the laboratory atmosphere and enabling responsible control of chemical usage and potential solvent recycling. A variety of cold traps are available from Welch. Contact your closest Gardner Denver Welch Vacuum Technology sales office or visit the Welch Web-Site at www.welchvacuum.com.

2.35 CAPTURE™ Cold trap

Your Welch Self-Cleaning Dry Vacuum System can be extended to include a CAPTURE™ cold trap. This trap is a pump-mounted condenser utilizing recirculating chilled water can be configured to remove solvent fumes from the vacuum stream either prior to the pump inlet to lessen solvent ingestion or on the pump outlet to reduce emissions. The CAPTURE trap provides continuous solvent condensation without the need to recharge a cold trap with dry ice / isopropanol or liquid nitrogen. Contact your Welch representative for more CAPTURE information or see www.welchvacuum.com

2.36 The Care of a Liquid Trap

A liquid trap needs no refrigerant. The key maintenance issue when pumping high vapor loads is to regularly drain the trap of liquid ejected from the dry vacuum pump.

2.37 The Care of a Cold Trap

When using a cold trap the refrigerant should be maintained at a high level in the flask to keep the trap at a uniformly low temperature. If the trap is rewarmed it may allow re-evaporation of the condensate. If the trap becomes saturated it should be disconnected from the system, drained and cleaned. An increase in pressure in the vacuum system will normally indicate that the trap has become saturated. To clean the trap, remove the trap from the system and allow the trap to warm up and rinse off the condensate with a suitable solvent in a fume hood. Thoroughly clean and dry the trap before reinstalling the system. If a liquid nitrogen trap is used, the refrigerant add tube on the liquid nitrogen trap should not be obstructed as the refrigerant boil-off can produce dangerously high pressures.

2.38 Application Note for Cold Trap

Cold traps employing a dry ice slurry or liquid nitrogen are effective as long as the refrigerant level is maintained. If the trap warms up while the pump is running, all of the trapped condensable will be ingested by the vacuum pump. Cold traps must be cleaned out at the end of each day. If the pump is run overnight, the trapped condensable will ultimately be ingested by the pump as the trap warms up. Cleaning a Dry Ice Slurry/Liquid Nitrogen trap is easy. The steps are:

1. Turn off the pump.
2. Leak air into the trap.
3. Remove the center well and Plexiglas ring to a hood. The center well can be washed off into a beaker or the condensable can be allowed to evaporate in the hood.

Section 3: COMPONENTS, SYSTEM AND UNIT OPERATION

3.10 Components

- 3.20 Control Locations
 - 3.21 Control Locations for Models 2025, 2026 and 2027
 - 3.22 Control Locations for Model 2028
- 3.30 Vacuum Gauge / System Function
 - 3.31 Vacuum Gauges for Models 2025 and 2026
 - 3.32 Vacuum Gauge / System Control Function for Model 2027
 - 3.33 Vacuum Gauge / System Control Function for Model 2028
- 3.40 Vacuum Level Regulation
- 3.50 Gas Ballast
- 3.60 Rapid Response Vacuum Adjustment
- 3.70 Inlet and Outlet Separators (all Models)

3.20 Control Locations

3.21 Control Locations for Models 2025, 2026 and 2027

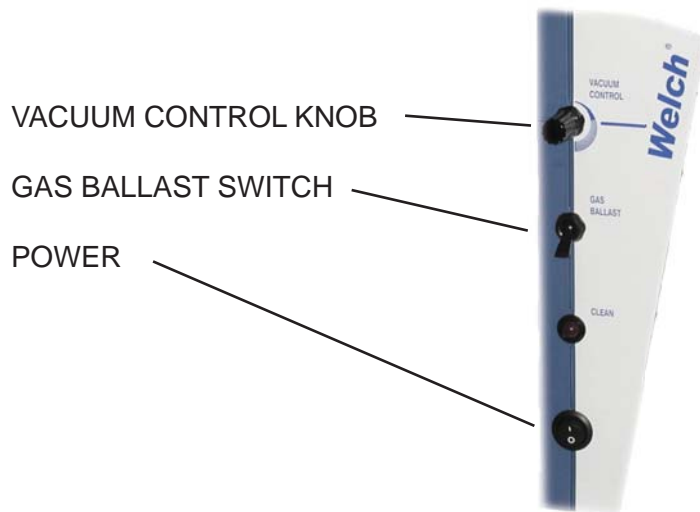

3.22 Control Locations for Model 2028

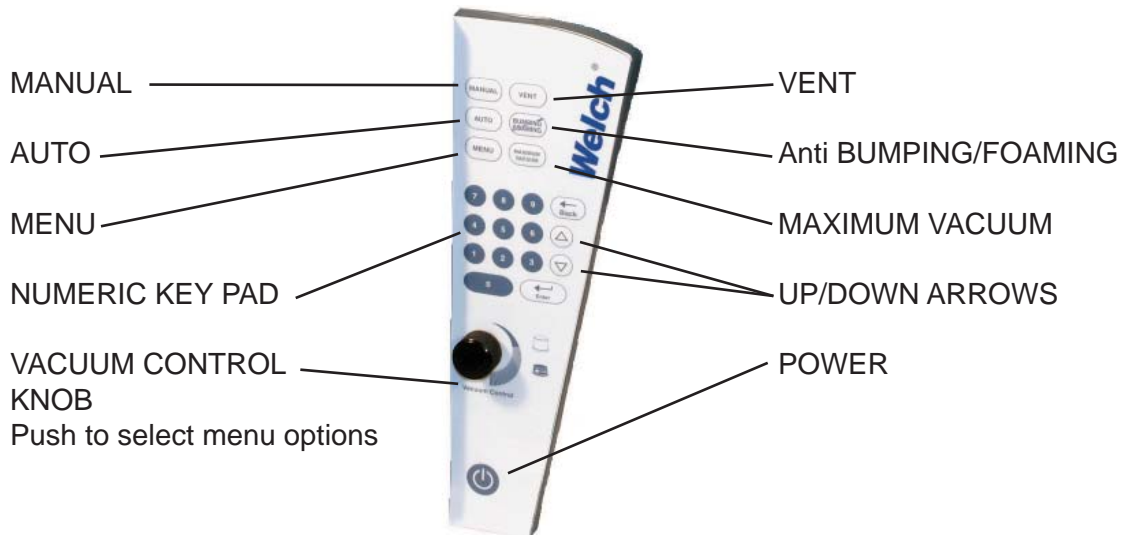

3.30 Vacuum Gauges / System Control Functions

3.31 Analog Vacuum Gauge for Models 2025 and 2026

A dial vacuum gauge is incorporated in the vacuum system 2025 and 2026. The dial gauge is located in the top front section of the system. The dial vacuum gauge is commonly used to indicate vacuum level when operating in the rough vacuum range (2 torr, 2.7mbar, 29.8 in Hg). Dial vacuum gauges give negative pressure - That is pressure below atmospheric. The reference point for the gauges is atmospheric pressure.

Please keep in mind that atmospheric pressure tends to vary from day to day. As a result of this variability, a dial vacuum gauge will indicate slightly different maximum vacuum readings from day to day.



3.32 Vacuum Gauge / System Control Function for Model 2027

A digital vacuum gauge is incorporated into the model 2027 vacuum system. The digital gauge is an absolute gauge located in the top front section of the Self-Cleaning system. The unit of measurement is preset during production.

Unit Set Up

Plug power cord from unit into wall outlet, press POWER and VENT; hold down until the MENU SCREEN is displayed.



Using the Menu

To use the menu, scroll through the menu options, using the VENT button.

To select the menu options, using the POWER button.



Change Units

To change pressure read out units, select through the MENU SCREEN:

SETUP > SET UNITS.

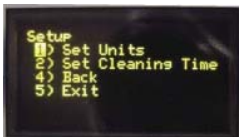

Select Units

To set units, chose the appropriate unit from the SELECT UNITS SCREEN.

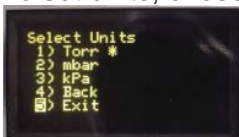

Change Cleaning Time

To change cleaning time, select through the MENU SCREEN:
SETUP > SET CLEANING TIME.

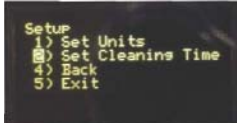

Select Cleaning Time

To set cleaning time, chose the appropriate time from the
SELECT CLEAN TIME SCREEN; default value is 120 seconds.
Use longer clean times to purge low-volatility solvents.

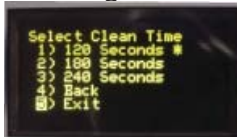

Unit Software Information

To retrieve information about the unit, select through the MENU SCREEN:
ABOUT.



Model / Software Version / Contact
are displayed as shown in this Figure.



3.33 Vacuum Gauge / System Control Function for Model 2028

A digital vacuum gauge is incorporated into the model 2028 vacuum system. The digital gauge is an absolute gauge located in the top front section of the Self-Cleaning system. The unit of measurement is preset during production.

VENT MODE

Press VENT button to enter VENT mode

Note: the gauge will not display atmospheric pressure.

The pump will automatically go into vent mode when the pump is turned on. VENT Mode is the central mode to allow the user to enter MENU, AUTO, MANUAL and MAXIMUM VACUUM modes. VENT mode allows the user to quickly remove the vacuum setting on an application and vent the system. All programs are quickly accessible in VENT mode by pressing the numeric keypad for each program number.

Example:

Keypad #	Program #
0	Repeat Previous Setting
1	1
2	2
3	3
4	4
5	5

Note: Press the ENTER button to run the selected program

MANUAL MODE

Press MANUAL button to enter MANUAL mode

MANUAL mode gives you full control of the vacuum setting by manually opening/closing the variable valve with each turn of the Vacuum Control knob. The linear bar graph displays the valve position. Push the Vacuum Control knob to lock in your desired vacuum setting and switch to AUTO mode. AUTO mode will display the exact vacuum setting and allow you to use all AUTO mode functions.

Note: MANUAL mode defaults to the valve open (vent) position when pressed except when in MAXIMUM VACUUM mode where the valve will be in the closed (max vac) position.

AUTO MODE Press AUTO button or Vacuum Control knob in MANUAL mode to enter AUTO mode. AUTO mode gives you precise control of the vacuum setting via Up/Down arrows, numeric Keypad and the Vacuum Control knob. The bottom right of the display shows the set vacuum setting. The initial vacuum setting must be set via the numeric key pad and enter button. Once the initial value has been entered the Up/Down arrows, Numeric Keypad and the Vacuum Control knob will all allow precise vacuum control in AUTO mode. The only exception is when the users switches from MANUAL mode to AUTO by pushing the Vacuum Control knob (See MANUAL mode).





MAXIMUM VACUUM MODE

Press MAXIMUM VACUUM button to enter MAXIMUM VACUUM mode. MAXIMUM VACUUM mode closes the valve and sets the pump to the maximum vacuum level. To adjust the vacuum level in MAXIMUM VACUUM mode you can press the MANUAL mode button and use Vacuum Control knob to open/close the variable valve (see manual mode) or press the Anti-BUMPING/FOAMING button to decrease the vacuum level by several torr.

Note: Selecting MANUAL mode while in MAXIMUM VACUUM sets the unit in MANUAL mode with the valve in the closed (maximum vacuum) position.

Anti-BUMPING/FOAMING MODE

Press Anti-BUMPING/FOAMING button to enter Anti-BUMPING/FOAMING mode. The anti-BUMPING/FOAMING functions will decrease the set vacuum level by several torr. Continual pressing of the Anti-BUMPING/FOAMING button will decrease the vacuum setting an equally additional several torr, mbar or kPa.

The anti-BUMPING/FOAMING is only enabled in AUTO mode. Press once and the vacuum decreases, press a second time and the unit goes back to MAXIMUM VACUUM.



MENU MODE

Press MENU to access all program functions

- 1) Repeat
- 2) Program
- 3) Setup
- 4) About
- 5) Exit

Use the Vacuum Control knob to scroll through all the MENU options. Push the Vacuum Control knob to select a highlighted MENU option

- 1) REPEAT

Repeat displays the previous run vacuum setting or program number. Use the Vacuum Control knob to scroll to the Repeat option and press to repeat previous setting.

Note: The Repeat option is quickly accessible in VENT mode by pressing number "0".

- 2) PROGRAM



Selecting the Program option allows the end user to select from one of five stored programs, enter a new program or edit an existing one. Use the Vacuum Control knob to scroll to the Program option and press to enter the Program menu screen.

The Program screen displays all existing stored programs in desired vacuum units and time (minutes). Use the Vacuum Control knob to scroll up and down and press the Vacuum Control knob to enter your selection.



If the memory location is empty the following screen will appear. Enter the values requested, first vacuum setting (P1), first time setting in minutes (T1), second vacuum setting (P2), second time setting in minutes (T2). If P1 is entered and T1 is left blank the program will only store a vacuum setting. If T1 and/or T2 is left blank, P2 will be set to run until unit is manually turned off. If the values are entered correctly and have been saved, the program will redisplay the entered values with the option to Edit, Run or Exit the program you just entered.

After each program ends with a timed value, the unit will automatically go into VENT, or Self-Cleaning mode if Auto Shutdown is Enabled in Setup. (see Setup)



If the memory location is full. The following screen will appear and request if you want to Edit, Run or Exit the program. Use the Vacuum Control knob to select your option.

All programs are quickly accessible in VENT mode by pressing the numeric keypad for each program number.

Example:

Keypad #	Program #
1	1
2	2
3	3
4	4
5	5

Note: All pressure values will be entered according to the predefined unit settings (torr, mbar, kPa). Time will be entered in minutes.

SETUP MODE

Press SETUP to access all program functions

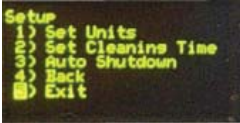

- 1) Set Units
- 2) Set Cleaning Time
- 3) Auto Shutdown
- 4) Back
- 5) Exit

Use the Vacuum Control knob to scroll through all the MENU options. Push the Vacuum Control knob to select a highlighted MENU option

- 1) SET UNITS

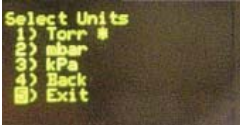

Use the Vacuum Control knob to select the Set Units option to change displayed units from torr, mbar, and kPa. The Selecting Units screen will appear and display the current units setting with an asterisk. Use the Vacuum Control knob to select the desired units and push the Vacuum Control knob to change. The screen will now display the new vacuum units.

Use the Vacuum Control knob to select Exit or Back to make additional changes from the Setup screen.

- 2) SET CLEANING TIME

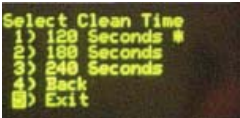

Use the Vacuum Control knob to select the Set Cleaning Time option to change the Self-Cleaning cycle time from 2, 3 or 4 minutes. The Select Clean Time screen will appear and display the current setting with an asterisk. Use the Vacuum Control knob to select the desired time and push the Vacuum Control knob to change. The screen will now display the new vacuum units. Use the Vacuum Control knob to select Exit or Back to make additional changes from the Setup screen.

- 3) AUTO SHUTDOWN

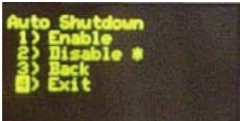

Auto Shutdown mode allows the user to enable or disable shutting down the unit after a timed program has run. When Auto Shutdown is Enabled the unit will automatically entered a timed Self-Cleaning cycle after a time-entered program has completed. If Auto Shutdown has been Disabled the unit will automatically go into vent mode and have to be manually turned off after a time entered program has completed.

Note: The Self-Cleaning cycle is a key component of the Self-Cleaning pump and cannot be disabled.

Use the Vacuum Control knob to select the Auto Shutdown option to Enable or Disable the Auto Shutdown feature after a program has been completed. The Auto Shutdown screen will appear and display the current setting with an asterisk. Use the Vacuum Control knob to select the desired option and push the Vacuum Control knob to change. The screen will now display the new setting. Use the Vacuum Control knob to select Exit or Back to make additional changes from the Setup screen.

- 4) ABOUT

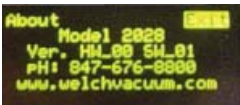

Use the Vacuum Control knob to select the About option. The About option lists the product model, version and contact information.

3.40 Vacuum Level Regulation

Vacuum level regulation is accomplished with an adjustable bleed valve. The adjustable bleed valve allows close control of pressure in your apparatus. Pressure may be set between roughly atmospheric pressure and the maximum obtainable vacuum (2 torr, 2.7mbar, 29.8 in Hg).

3.50 Gas Ballast Valve (Models 2025, 2026 & 2027 only)

Failure of a diaphragm pump using fluorinated plastics commonly comes from the buildup of liquids or solid residue over time on the diaphragm or internal valves. Any particulates, water or condensed vapor that may have been ingested into the diaphragm pump, which is the heart of the Self-Cleaning Dry Vacuum System, is purged when the system is turned off. The self-cleaning purge automatically turns on for approximately 2 minutes upon turning off the pump. The digital display will count down in seconds the time left in the purge cycle. During the last 10 seconds of the purge cycle the pump will shut off allowing the unit to vent to atmospheric pressure.

3.60 Rapid Response Vacuum Adjustment

Foaming or bumping in a rotary evaporator can be caused by excessively high vacuum levels. Your Self-Cleaning Dry Vacuum system enables fast response to foaming and bumping. Depending upon your Model, a toggle switch or button can instantly adjust vacuum levels to approximately 10 torr higher by incrementally changing the gas ballast valve.

Models 2025, 2026 & 2027 have a toggle Gas Ballast Valve to enable Rapid Response Vacuum Adjustment. By moving the Gas Ballast Valve toggle switch to its upward position, the valve is opened. This open valve allows air to enter the pump's second stage, reducing the vacuum level. This reduction will be most effective at eliminating bumping and foaming in the low Torr range; vacuum will typically increase 10 to 15 Torr. Higher Torr evaporations (e.g. methylene chloride) may also require adjustment of the vacuum level using in the regulator. Operation with the gas valve open will also reduce condensation in the pump's second stage, increasing efficiency and extending service life.

Prolonged operation of the pump with the Gas Ballast Valve open is not injurious to the pump. As your evaporation progresses to the point where bumping or foaming is no longer a potential problem, close the gas ballast valve to enable maximum vacuum.

Model 2028 provides Rapid Response Vacuum Adjustment by use of the Anti-Bumping / Foaming button. Pushing this button increases your vacuum set point by 10 Torr. The variable control valve opens incrementally to admit air to both stages of the pump and the vacuum level is now controlled 10 Torr higher than the previous setting. Pushing the Anti-Bumping / Foaming button a second time will raise the set point another 10 Torr.

Prolonged operation of the pump at any vacuum setting is not injurious to the pump. As your evaporation progresses to the point where bumping or foaming is no longer a potential problem, you can increase vacuum by lowering the set point in "Auto" mode or switching to "Manual" mode and pushing the Maximum Vacuum button



(Model 2027 shown. Models 2025 and 2026 come with a dial vacuum gauge)

3.70 Inlet and Outlet Separators (all Models)

The glass inlet separator helps protect the diaphragm pump inside the system from ingesting liquids or particulates. The outlet separator catches any liquid or particulates ejected while the pump is running and when its is operating in the self-cleaning purge cycle. See Section 2.30 for more information about trapping.



WARNING

Always wear safety gloves that are designed for handling glass when removing the inlet or/and exhaust jars. Cracked or defective jars can break when being removed.

3.80 Unit Start Procedure and Operation

NOTE

Pump will not reach Ultimate Vacuum Pressure until pump has been run and warmed up.

3.81 Starting a Welch Vacuum System

Before attaching the Self-Cleaning Dry Vacuum System to a rotary evaporator, concentrator or gel dryer it is important to familiarize yourself with the function, features and action of the Self-Cleaning Dry Vacuum System which you have acquired. Review the power requirements as described in Section 2.20, Electrical Power Welch recommends running the system for a few minutes to warm it up before use. The warm-up improves the pumps ability to pass water and organic vapor. A warm pump will handle more vapor without liquefying it than a cold pump.

3.82 Cleanliness

Take every precaution to prevent foreign particulates or liquid from entering the pump. Particulates or a flow of liquid will damage the pumps performance. See Section 2.30 for information on the use of Traps.

3.83 Leak Detection

The importance of eliminating all leaks in a vacuum system is obvious. The pump must remove this added volume of leaked gas to maintain the desired vacuum. Leaks in the application can be located by slightly pressurizing the system and painting the suspected area with a thick soap solution. Escaping air will produce soap bubbles.

3.84 Operating Pressure Range

The Self-Cleaning Dry Vacuum System is designed to be run from slightly below atmospheric to 2 Torr (2.7mbar, 29.8 in Hg) See Section 7, specification list for the complete specifications for your unit.

Section 4: MAINTENANCE

4.10 General Maintenance

Welch dry vacuum units are 100% oil-free. The pump employs a diaphragm with uninterrupted PTFE coating. No maintenance is necessary for the bearings. All bearings are sealed and permanently lubricated. Lubrication should not be attempted.

Welch's Recommendation:

To extend the service life of the diaphragm membrane, turn off the Self-Cleaning Dry Vacuum System when not in use. Running the system when not being used only creates wear on the flexing membrane in the pump. When running the pump for several hours at a time in an application, Welch recommends air, vapor or gas pass through the pump rather than run in a blank-off condition. The air, vapor or gas aid in cooling of the pump mechanism extending the membrane's service life.

Section 5: CALIBRATION

5.10 Starting the Calibration for Model 2027 only

Under normal conditions the digital vacuum gauge on model 2027 vacuum system should not need recalibration as it has been factory set. To recalibrate the unit an external vacuum gauge capable of measuring down to 2 Torr or less will be required.

Step 1: With unit powered off press and hold both the power and vent buttons until the MENU screen is in the display.



Step 2: Use the vent button to select About (menu item 2). Press the power button when About menu item is selected.



Step 3: The About screen will now be in the display.

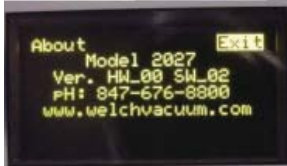

Now press both the power and vent buttons together to go to the CALIBRATION/INFO screen.



Step 4: Use the Vent button to select Calibrate Sensor (menu item 1).
When Calibrate Sensor is selected press the power button.



The unit will now go into calibration mode with Calibrate ATM in the bottom line of the display and 750 in the main line.



Step 5: Use the VENT button to change the display so that the correct atmospheric pressure is displayed. Each press of the Vent button will increment the display by one. When the display reaches 800 it will go to 700 and start going up again. When the correct pressure is reached press the Power button. The top end of the sensor is now calibrated for atmospheric pressure.



Step 6: The pump will now turn on and the Vent valve will close. Calibrate vacuum will be displayed in the bottom line and a value above 3000 in the main line depending on the vacuum. Make sure the variable leak valve and Gas Ballast are completely closed. Attach the pump to the secondary gauge with bleed valve attached and adjust pressure to $3 \pm .1$ Torr.

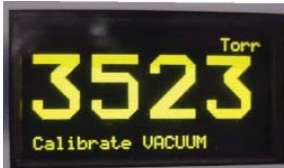

Step 7: When the vacuum on the secondary gauge is 3 Torr press the Power button. This will calibrate the bottom end of the vacuum sensor. The calibration message in the bottom line will go away and the main line will now display the vacuum in Torr. Calibration is now completed.

Section 6: TROUBLESHOOTING

6.10 Vacuum Problems

Leakage, contamination and unusual out gassing are the general causes of problems associated with poor vacuum. To operate at maximum efficiency a system must be thoroughly clean. If the system is completely clean and free from leaks, and unwarrantable vacuum problems still exist, the pump should be checked. A simple criterion for checking the condition of the pump is the determination of its maximum vacuum capability. This can be accomplished by blocking off the intake and reading the vacuum level on the gauge (See Section 3.30).

Problem		Possible Cause	Solution
Mechanical Failures	Pump not working	<ul style="list-style-type: none"> Power off 	<ul style="list-style-type: none"> Check all power connections
		<ul style="list-style-type: none"> Pump under Vacuum 	<ul style="list-style-type: none"> Disconnect pump from system. Open vacuum control valve and Gas ballast.
		<ul style="list-style-type: none"> Self Diagnostic Test 	<ul style="list-style-type: none"> Do nothing - The pump is running a 30sec. Self diagnostic test to ensure all components are working correctly. <p>If problem persists, contact Welch Technical Support*.</p>
	Pump stalled	<ul style="list-style-type: none"> Pump under vacuum <p>Note: Pump Cannot Start Under Vacuum</p>	<ul style="list-style-type: none"> Open vacuum control valve and gas ballast.
			<ul style="list-style-type: none"> Turn-off and UNPLUG PUMP, remove top housing and turn fan a few times. Replace cover and turn on, if problem still continues contact Welch Technical Support*. Turn pump off, disconnect from application, restart pump
	Display shows unreliable measurements	<ul style="list-style-type: none"> Check vacuum pressure of 2027xx with external vacuum gauge, attached to pump inlet fitting. 	<ul style="list-style-type: none"> If external vacuum gauge pressure is different than unit's display by more than 5 Torr, problem is with one of three electronic parts (electronic problems): <ul style="list-style-type: none"> - Vacuum pressure display - Pressure pickup - Electronic board
		<ul style="list-style-type: none"> Loose or not completely inserted wire or connector 	<ul style="list-style-type: none"> All electronic connections on electronic board and vacuum display should be rechecked to see that there is no
		<ul style="list-style-type: none"> Multi wired pickup ribbon connection at pressure pickup may have loose/broken one of the four wires (usually one of outside wires). 	<ul style="list-style-type: none"> New pickup should be installed or repaired by re-soldering loose wire to pressure pickup.
		<ul style="list-style-type: none"> Electronic board could have corrupted software or calibration 	<ul style="list-style-type: none"> Faulty board should be returned to the factory to exchange it for new one

Problem		Possible Cause	Solution
Mechanical Failures	Insufficient Vacuum	• External connection leak	• Check and tighten all external tubing connections; check tubing for cracks; tighten connections in PTFE heads
		• Gas Ballast is On	• Switch Gas Ballast to OFF position
		• Vacuum Control is not Closed	• Closed Vacuum control (CW)
		• Jar "Intake Side" is not tightened in place	• Use Rubber Wrench to tighten jar
		• Check vacuum pump pressure with external vacuum gauge, attached to pump inlet fitting	• If external vacuum gauge pressure is the same as unit's display, problem is with faulty pump or external connection leaks (mechanical problems)
		• Solenoid valve is not operating properly	• Valve is always in closed position except purge cycle. Remove valve silencer and plug valve inlet with rubber stopper. If pressure drops it indicates leaky valve.
		• Internal leak	• Bad valve or bad diaphragm; both bad parts also effect noise; if there is no vacuum, intake stage is problem. • Vacuum level around 30-40 Torr indicates bad exhaust stage, valve or diaphragm.
	High noise	• Bad valve or diaphragm	• Change Valve / Diaphragm
		• Loose eccentric or counterweight	• Tighten Loose Parts. Use Loctite
		• Broken diaphragm threaded insert	• Change Diaphragm
		• Bad Con-Rod bearing or motor bearing	• Change Con-Rod
		• Broken motor shaft	• Change Shaft
		• Loose housing cover	• Tighten housing screws on back of unit Slide rail loose, remove housing cover and slightly crimp slide rails on inner top of housing cover. Do not over crimp
		• Loose inlet/outlet jars	• Tighten jars
	Excessive vibration	• Damaged diaphragm	• Check vacuum performance - See Poor Vacuum section below If vacuum is still poor, contact Welch Technical Support*
		• Loose motor mounting screws	• Tighten screws
	Slow pump-down	• Incorrectly installed counterweight or wrong Counterweight	• Adjust/reinstall/change Counterweight
		• Failures described above also contribute to excessive noise	
		• Indicates partially plugged passage, usually in exhaust stage	• Clean/Unplug Stage
		• Plugged silencer	• Unplug /change silencer

Problem		Possible Cause	Solution
Mechanical Failures	Seized pump	<ul style="list-style-type: none"> Motor failure 	<ul style="list-style-type: none"> Change Motor
		<ul style="list-style-type: none"> Broken diaphragm – Con-rod connection 	<ul style="list-style-type: none"> Change Diaphragm and/or Con-Rod
	Analog gauge	<ul style="list-style-type: none"> Poor readings 	<ul style="list-style-type: none"> See section 2.25.1 Analog Vacuum Gauge Check vacuum performance - See Poor Vacuum section above
		<ul style="list-style-type: none"> Gauge not responding 	<ul style="list-style-type: none"> Remove housing cover - check connections and ensure hose is not kinked. If hose is loose or kinked, reattach or straighten. If problem persists, verify vacuum with independent vacuum gauge. If independent vacuum gauge reading is still poor, Contact Welch Technical Service.
	Digital gauge	<ul style="list-style-type: none"> Poor readings 	<ul style="list-style-type: none"> See section 2.25.2 Digital Vacuum Gauge Check vacuum performance with independent gauge - See Poor Vacuum section above
		<ul style="list-style-type: none"> No display 	<ul style="list-style-type: none"> Check power and power cord Turn pump off and UNPLUG PUMP, wait 30 seconds, re-connect to power and turn pump back on.
		<ul style="list-style-type: none"> Displays “CAL Err” 	<ul style="list-style-type: none"> Unit has detected a calibration error.
	Poor Vacuum	<ul style="list-style-type: none"> Leaks 	<ul style="list-style-type: none"> Check inlet jar for leaks - Check inner gasket and fittings, tighten if loose. Disconnect pump from system, block off inlet port, check vacuum level on the gauge. If vacuum level reading is good, work back through your application checking for leaks. If vacuum level reading is still poor, check vacuum control valve and gas ballast to ensure they are completely closed. If vacuum level reading is still poor, disconnect pump from the application and run the pump for 10 minutes with the inlet port open, turn unit off and allow the unit to complete purge cycle (clean). Repeat and retest vacuum performance. If problem persists, contact Welch Technical Support*.

Section 7: SPECIFICATION

7.10 Specification Table

Welch Model	2025 (Analog)	2026 (Analog)	2027 (Digital)	2028 (Digital)
Free Air Displacement				
CFM (L/min) @ 60 Hz	1.2 (34)	1.1 (32)	1.1 (32)	1.2 (35)
m3/hr (L/min) @ 60 Hz	1.7 (28)	1.6 (27)	1.6 (27)	1.8 (29)
Vacuum Level, in Hg	29.6	29.85	29.85	29.85
Ultimate Pressure, Torr (mbar)	9 (12)	2 (2.7)	2 (2.7)	2 (2.7)
Motor Horsepower (watts)	1/5 (150)	1/5 (150)	1/5 (150)	1/5 (150)
Bump/Anti-Foam Button	N/A	N/A	N/A	YES
Tubing needed, I.D. in (mm)	1/4" (7)	1/4" (7)	1/4" (7)	1/4" (7)
Intake / Exhaust Thread NPT	3/8	3/8	3/8	3/8
Weight, lbs (Kg)	30 (13.6)	30 (13.6)	30 (13.6)	30 (13.6)
Programmable				
Repeat Function	N/A	N/A	N/A	YES
Store Programs	N/A	N/A	N/A	up to 5
Timer	N/A	N/A	N/A	1-999 min.
Overall Dimensions				
L in. (cm)	13.6 (42.2)	13.6 (42.2)	13.6 (42.2)	13.6 (42.2)
W in. (cm)	12 (30.5)	12 (30.5)	12 (30.5)	12 (30.5)
H in. (cm)	11.3 (28.7)	11.3 (28.7)	11.3 (28.7)	11.3 (28.7)
Shipping Weight, lbs (kg)	36 (16.3)	36 (16.3)	36 (16.3)	36 (16.3)
Catalog Number				
Wired for 115V, 60Hz, 1 Ph with N. American 115V Plug	202501 1.5A	202601 1.5A	202701 1.5A	202801 1.5A
Catalog Number				
Wired for 230V, 50Hz, 1 Ph with Cont. Euro (Schuko) Plug	202503 0.75A	n/a	202703 0.75A	202803 0.75A
Catalog Number				
Wired for 100V, 50/60Hz, 1 Ph with N. American 115V Plug	202505 1.5A	n/a	202705 1.5A	202805 1.5A

Altitude 2000m

Max. relative humidity of 80% for temperatures up to 31C decreasing linearly to 50% at 40C

Supply Voltage +/-10%

Pollution Degree 2

Installation Category II



Models 202503 and 202703 conform to ATEX II 3G T4. [ATEX Group II (Explosive Atmospheres), Category 3G (Gases), Temperature T4 (135 C)]

Section 8: DRAWINGS, PARTS LISTS AND EXPLODED VIEWS

8.10 Dimensional Drawing

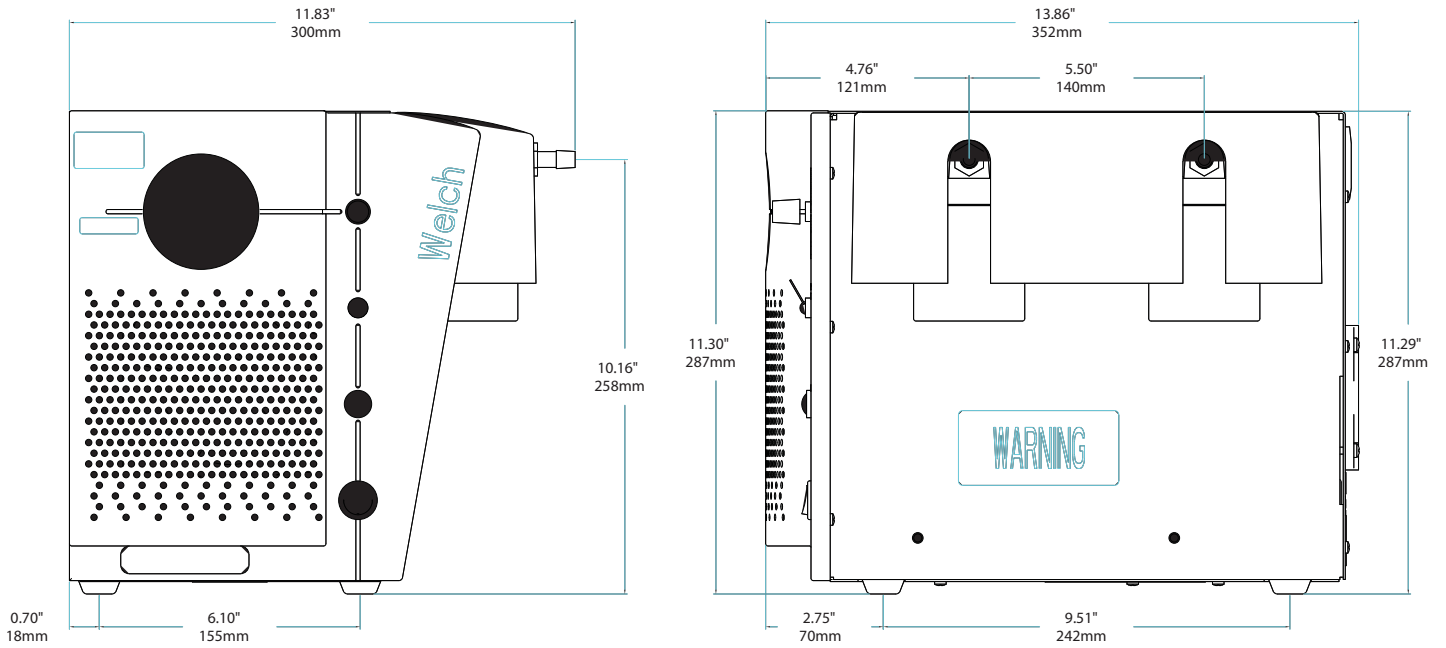

8.11 Schematic Wiring Diagram for Models 2025 & 2026

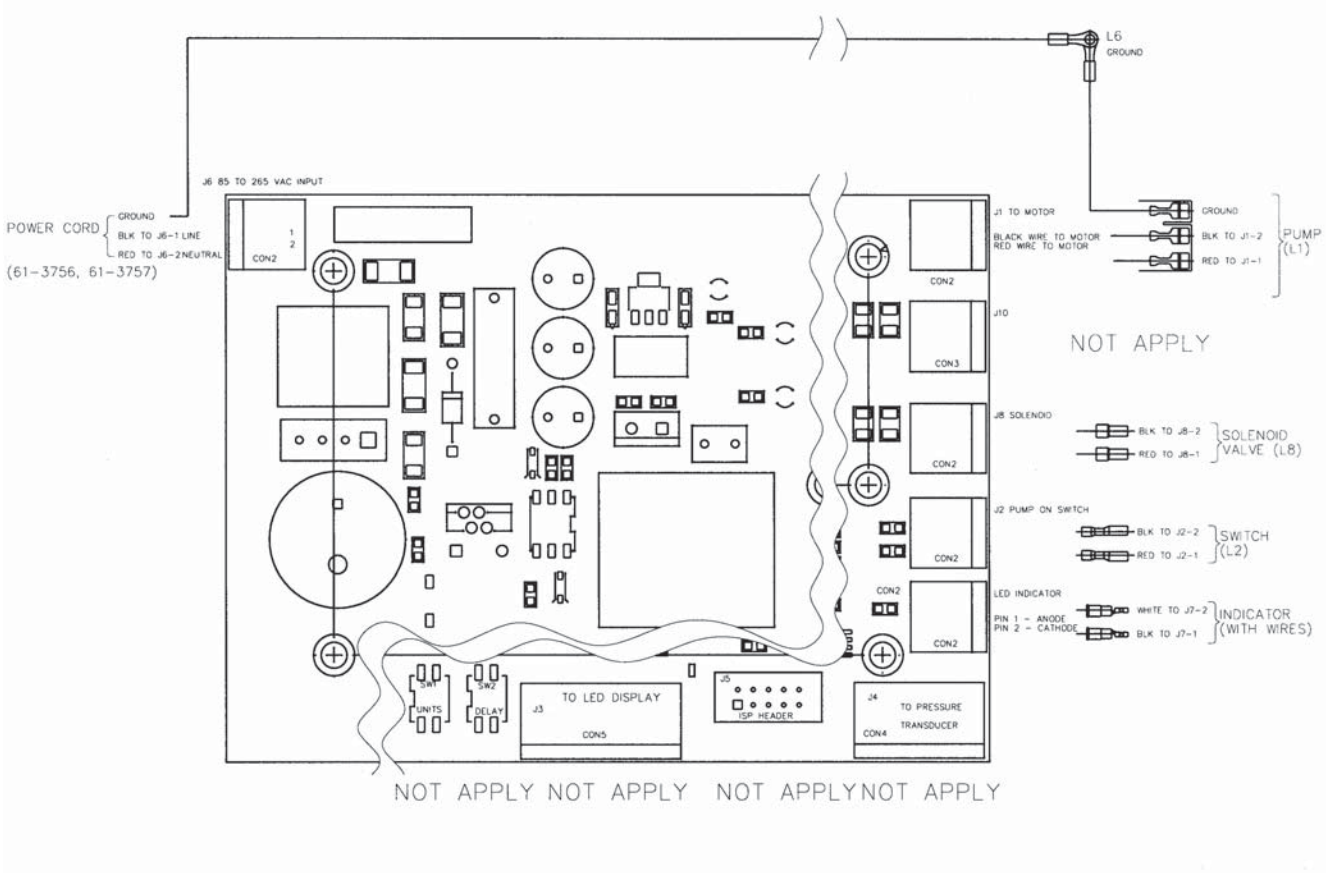

8.12 Schematic Wiring Diagram for Model 2027

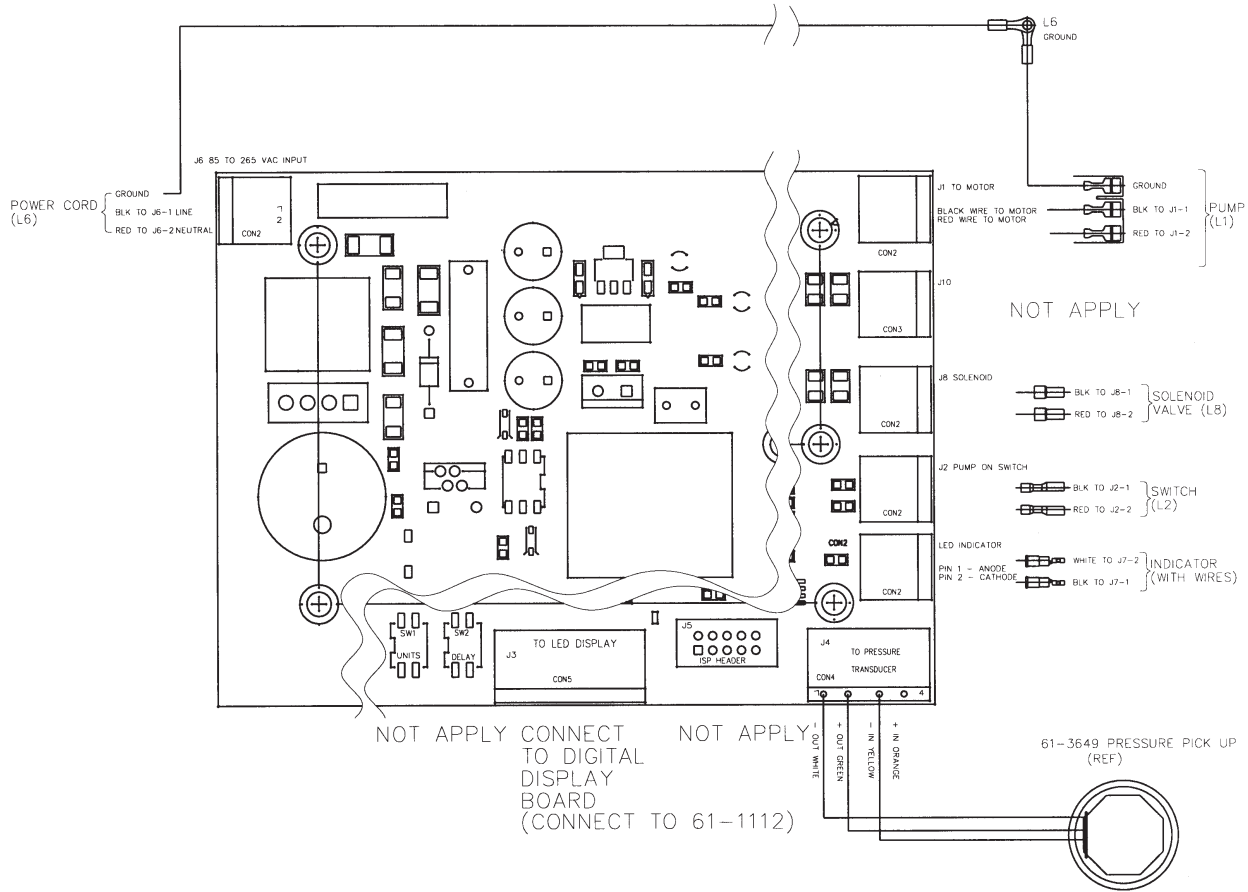

8.13 Schematic Wiring Diagram for Model 2028

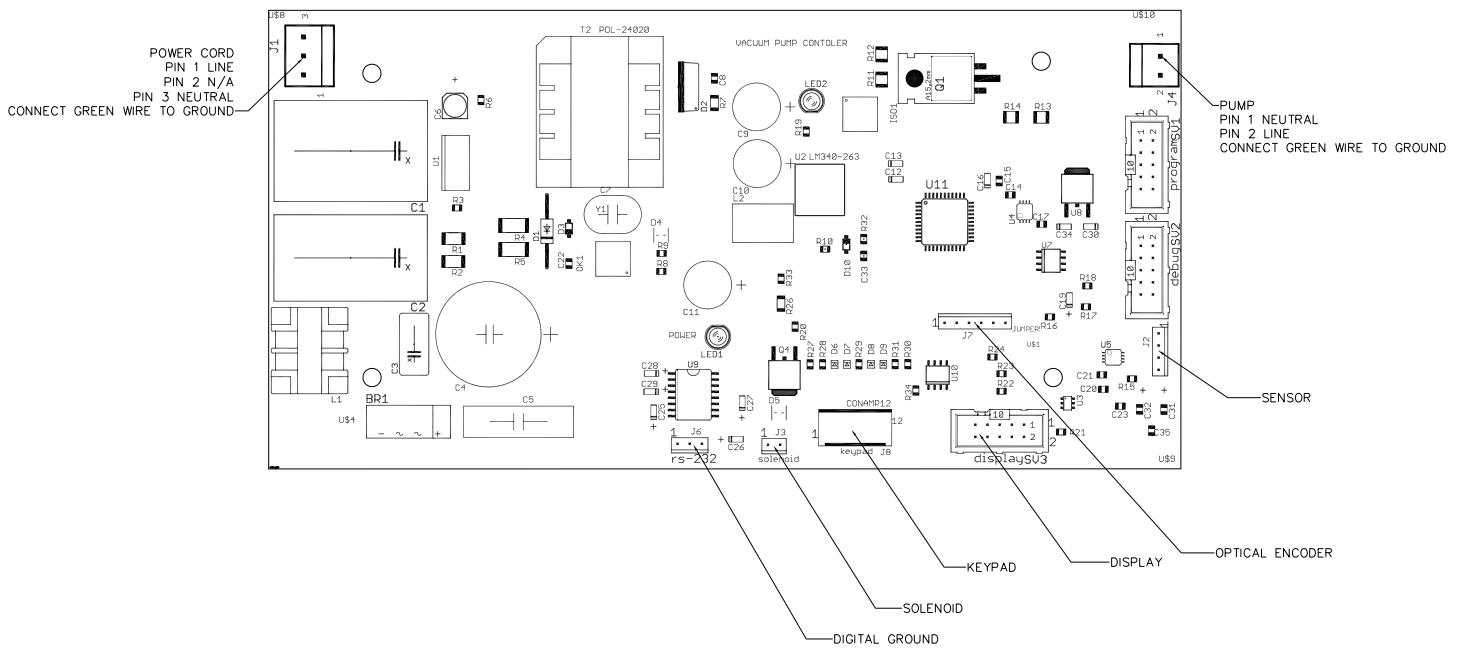

8.14 Parts List & Exploded View for Dry Vacuum System

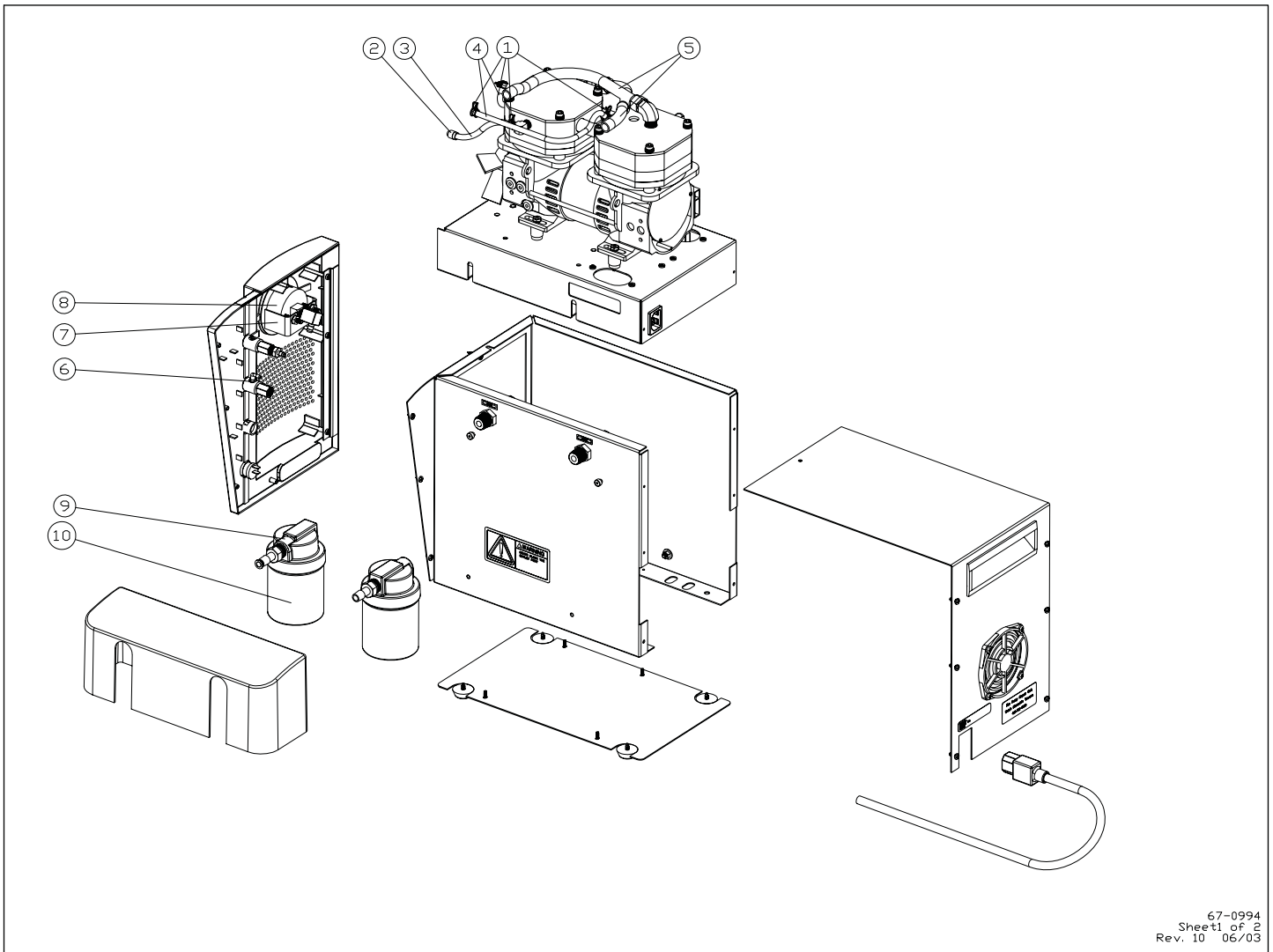

ITEM	QTY	PART NUMBER	DESCRIPTION	SERVICE KIT 2025K-06*
1	4	See Note 1	Hose Clamp 5/16"	4
2	2	See Note 1	Hose Clamp 1/8"	2
3	0.35 Ft	See Note 1	Tubing, Fluoroelastomer	0.35 Ft
4	1.60 Ft	See Note 1	Tubing, Blended	1.60 Ft
5	1.30 Ft	See Note 1	Tubing, PTFE Duality	1.30 Ft
6	1	See Note 1	Gasket	1
7	1	See Note 1	U-Clamp	1
8	1	726123	Vacuum Gauge 2" Dial (mbar / kPa)	-
8	1	726125	Vacuum Gauge 2" Dial (in Hg / cm hg)	-
9	2	1423B	Glass Jarr Assembly	-
10	2	1415B	Replacement Glass Jarr	-

Note: 1. These parts are not available seperately,
but they are supplied in the 2025K-06 Service Kit.

* for Models 2025, 2026, 2027 & 2028 with S/N > ECO91300

8.15 Parts List & Exploded View for Repair Kits

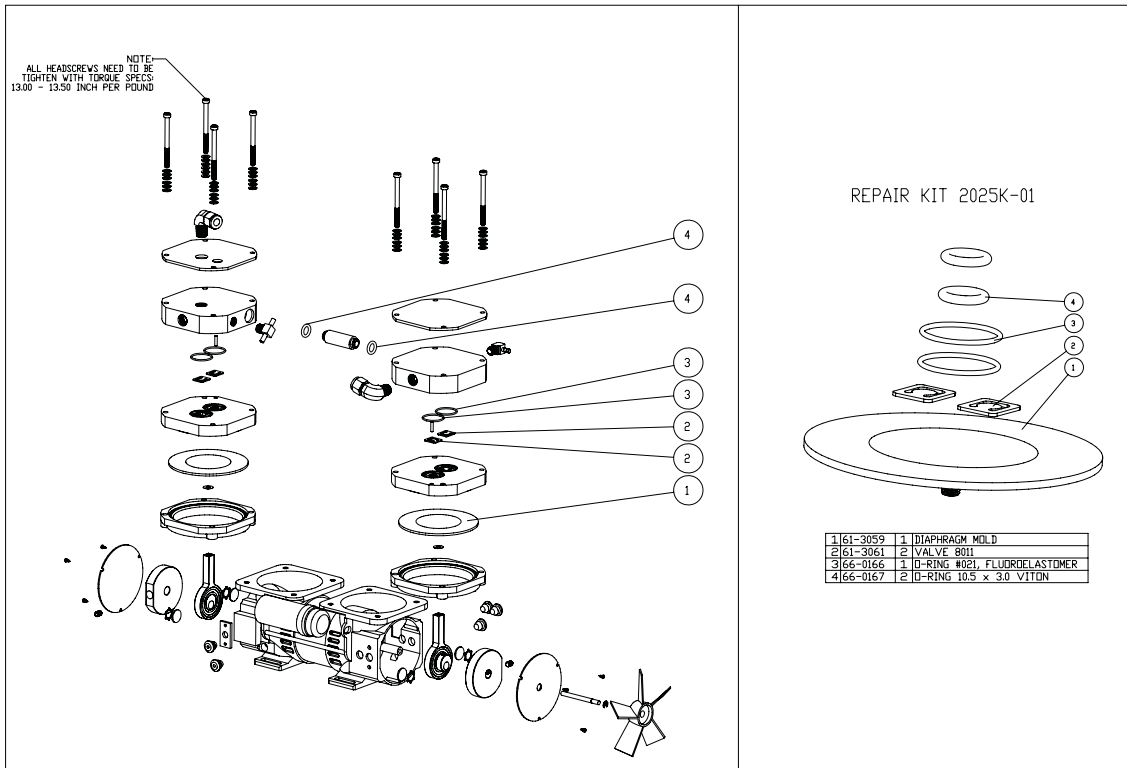

Repair Kit 2037K-01
(for Models: 2025)

This kit provides enough parts to service one side/head of this vacuum pump.

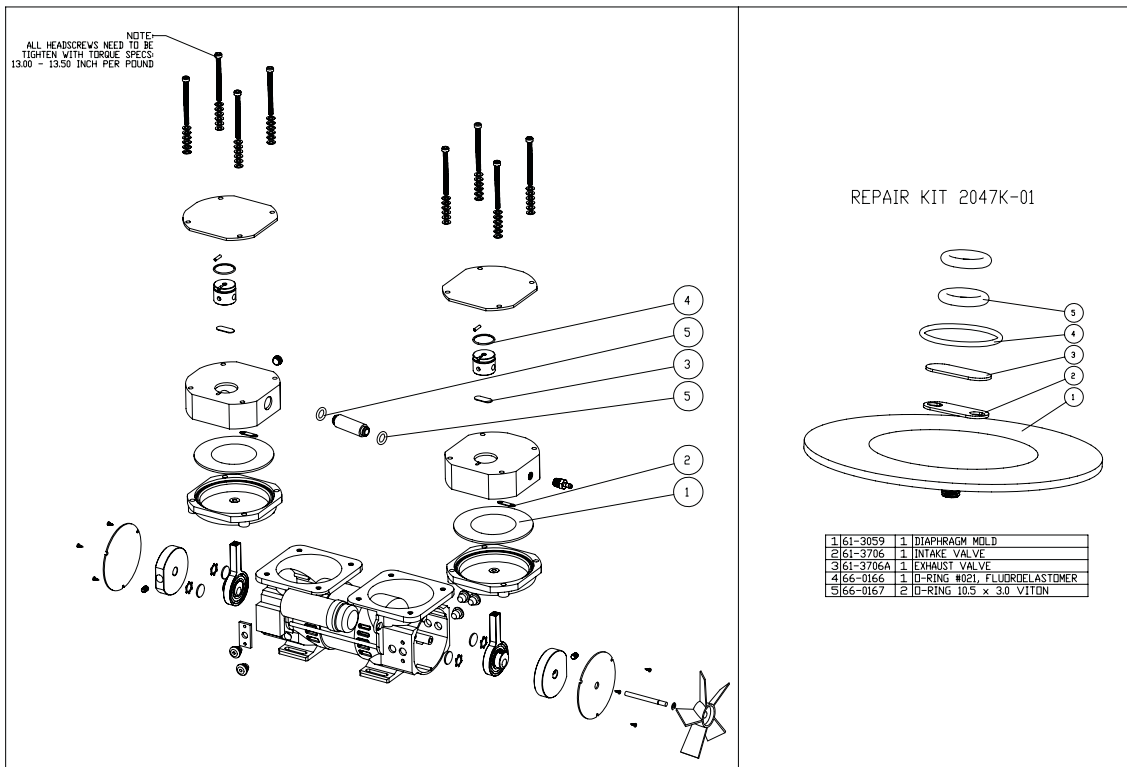

Repair Kit 2047K-01
(For Model: 2026, 2027 & 2028)

This kit provides enough parts to service one side/head of this vacuum pump.

Section 9: WARRANTY

IMPORTANT
Please Read Carefully Before Operating
This Welch® Vacuum Pump

UNPACKING

Inspect the pump carefully. If any damage has occurred, immediately file claim with the carrier immediately. Save the shipping container for carrier to inspect.

OPERATING PUMP

Refer to the enclosed Instruction/Operation Manual for all information to properly operate and maintain the pump.

WARRANTY

This Welch Vacuum product is warranted to be free from defects in material and workmanship. The liability of Welch-Ilmvac under this warranty is limited to servicing, adjusting, repairing or replacing any unit or component part which in the judgment of Welch-Ilmvac has not been misused, abused or altered in any way causing impaired performance or rendering it inoperative. No other warranties are expressed or implied. The method of executing this warranty: servicing, adjusting, repairing or replacing shall be at the discretion of Welch-Ilmvac. Vacuum pumps that have been used for any period, however short, will be repaired under this warranty rather than replaced.

The warranty is effective for one year from the date of original purchase when:

1. The warranty card has been completed and returned.
2. The product is returned to the factory or other designated service centers, freight prepaid.
3. The product in our judgment is defective through no action or fault of the user.

If the product has become defective through misuse, abuse, or alteration, repairs will be billed regardless of the age of the product. In this event, an estimate of the repair costs will be submitted and authorization of these charges will be required before the product is repaired and returned.

To reduce additional charges and delays either within or outside of the warranty period, contact Welch-Ilmvac @ 847-676-8800 for a return authorization number. Products without a return authorization number will be refused by our receiving department. Before shipping, properly pack the pump, insure it against loss or damage, and on the outside of the pump packaging and the packing slip write in the return authorization number. Pumps damaged during return shipment to Welch due to improper packaging are the customer's responsibility.

Welch-Ilmvac
5621 W. Howard Street
Niles, IL 60714
Phone: (847) 676-8800 (Technical Support)
Fax: (847) 677-8606
E-Mail: gdwelchvacuum@gardnerdenver.com
Web-Page: www.welchvacuum.com